

MANUAL INSTRUCTION

GAZEBO WITH SIDEWALL CURTAINS

G30034GR-A



Outdoor Furniture

We are a professional furniture provider with top-notch factories and outstanding designs, Our mission is to provide consumers with new lifestyles. By collecting consumer feedback, we constantly improve our products and create more choices for consumers. If you want to create your space, We are an ideal choice.

Always.



WARNING

- 1. Two or more people are required for assembly.**
- 2. A ladder and electric drill may be necessary.**
- 3. Do not erect the structure in heavy winds or inclement weather.**
- 4. Do not leave up this unit for extended periods of time, as it is not a permanent structure or designed to withstand sustained wind or rain. It is a temporary, portable shelter that shields you from sunlight and rain. The screens also block flying insects.**
- 5. Do not use candles, matches, or any open flames near the tent.**
- 6. To better align the screws for practical situations, do not fully tighten screws initially.**
- 7. Professional installation is highly recommended**

WARNING

- In case of windy weather, please do not stand in the gazebo.
- Please do not stand under the gazebo in case of heavy snowfall.
- For safety, please use expansion screws to reinforce the posts to the ground.
- In windy weather, please tighten the fence and netting to avoid tearing in high winds.
- In extreme weather conditions, you can use a rope to pull the four corners of the gazebo to keep it stable.
- Please clear the snow off the roof in time for the heavy snowfall.
- Make sure all screws are tightened before use.
- Repeat to confirm all screws, buckles and straps every 90 days.
- Please keep all screws loose during the assembly process and tighten them after completing the installation.
- Do not use or store next to a pole with an open flame or flammable chemicals.
- Please note that some parts have sharp edges and should be handled with gloves.
- If any parts are missing, broken, damaged or worn, discontinue use of the product until repairs are made or factory replacement parts are installed.
- Installation of the product in a manner that does not conform to the manufacturer's instructions may result in the loss of the warranty policy for this product.

WARNING

WARNING: This product can expose you to Carbon monoxide, which is known to the State of California to cause birth defects or other reproductive harm. For more information go to www.P65Warnings.ca.gov

TOOLS REQUIRED

EQUIPMENT REQUIRED (Not included in boxes)

*NOTE: Tools / equipment are not shown to actual size and scale.



LEVEL



RUBBER Mallet



PHILLIPS SCREW



DRILL



ALLEN KEY

EQUIPMENT REQUIRED (Not included in boxes)

*NOTE: Equipment are not shown to actual size and scale.



SAFETY HAT



GLOVES



SAFETY GOGGLES



**STEPLADDER
(6.5ft Or More)**

Matters needing attention



*Three or more people
are required for
assembly*



*Do not fully tighten
screws prior to complete
assembly*

I HARDWARE

A



4 PCS

B

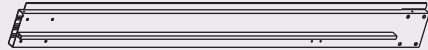

2 PCS

B1



2 PCS

C



2 PCS

C1



2 PCS

D



2 PCS

D2



4 PCS

E



4 PCS

E1

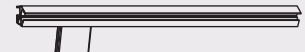

4 PCS

I HARDWARE

F



4 PCS

F1

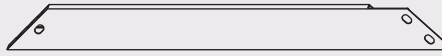

4 PCS

G

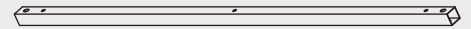

2 PCS

G1



4 PCS

G2



4 PCS

G3



2 PCS

G4



2 PCS

H



4 PCS

I



4 PCS

I HARDWARE

J

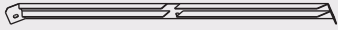

2 PCS

J1

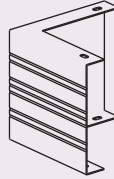

4 PCS

J2

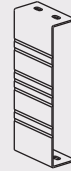

4 PCS

J3



2 PCS

K



1 PC

K1

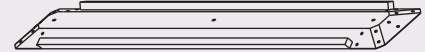

1 PC

L



4 PCS

M1

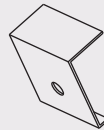

6 PCS

M2

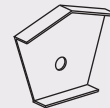

12 PCS

I HARDWARE

M3

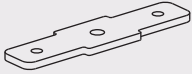

6 PCS

M4



4 PCS

M5

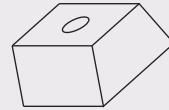

110 PCS

M6



8 PCS

P

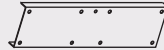

4 PCS

Q



96(+6) PCS

R1



2 PCS

R2



2 PCS

R



76 PCS

I HARDWARE

D1



16 PCS

NET

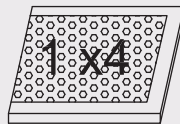

Curtain

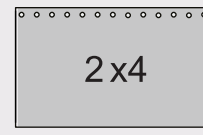

ZS3

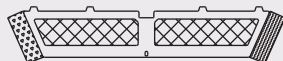

2 PCS

ZS8



2 PCS

P



2 PCS

P1



2 PCS

P2



2 PCS

P3

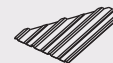

2 PCS

I HARDWARE

P4

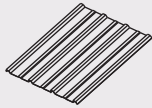

4 PCS

P5

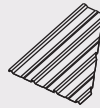

2 PCS

P6



2 PCS

O1



2 PCS

O2



2 PCS

O3

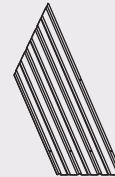

2 PCS

O4

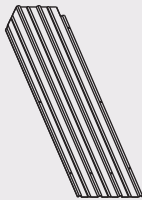

2 PCS

O5

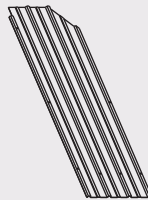

2 PCS

O6

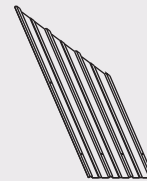

2 PCS

I HARDWARE

O7

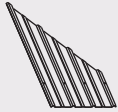

2 PCS

O8



2 PCS

N1



2 PCS

N2

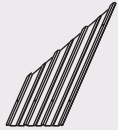

2 PCS

N3

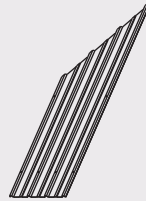

2 PCS

N4

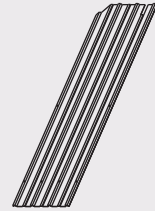

2 PCS

N5

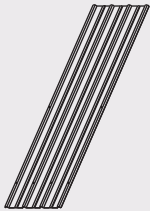

4 PCS

N6

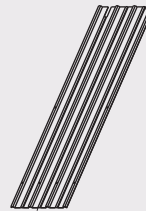

2 PCS

N7



2 PCS

I HARDWARE

N8



2 PCS

N9



2 PCS

PARTS

S

M6x47mm

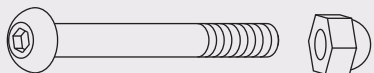

18(+2) PCS

T

M6x23mm

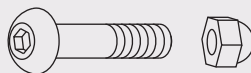

86(+9) PCS

U

M6x23mm

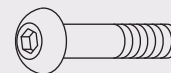

2(+2) PCS

V

M6x15mm



170(+10) PCS

V1

M4x12mm



16(+2) PCS

V2

M6x12mm



8(+2) PCS

X

M6x10(D10x20)mm



32(+3) PCS

X1

M6x42mm

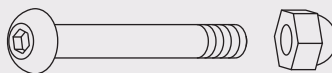

4(+2) PCS

Y

ST4.8x12mm



32(+10) PCS

I PARTS

Wa

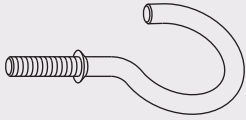

5 PCS

W2

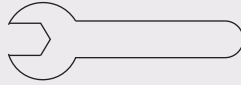

1 PC

Z



1 PC

Z1

M6x60mm

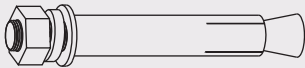

12 PCS



Z2



12 PCS

PRODUCT ASSEMBLY



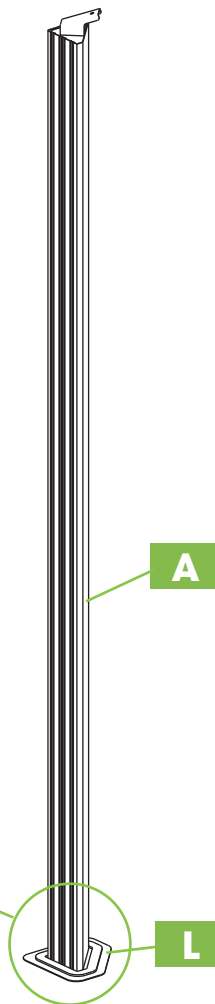
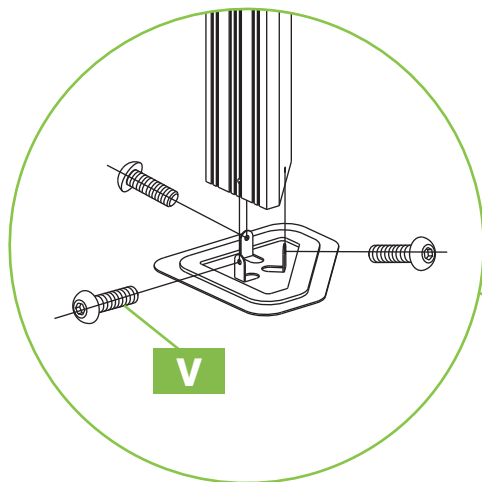

1

PART	NO.	QTY.
	A	4
	L	4
	V	12



PRODUCT ASSEMBLY



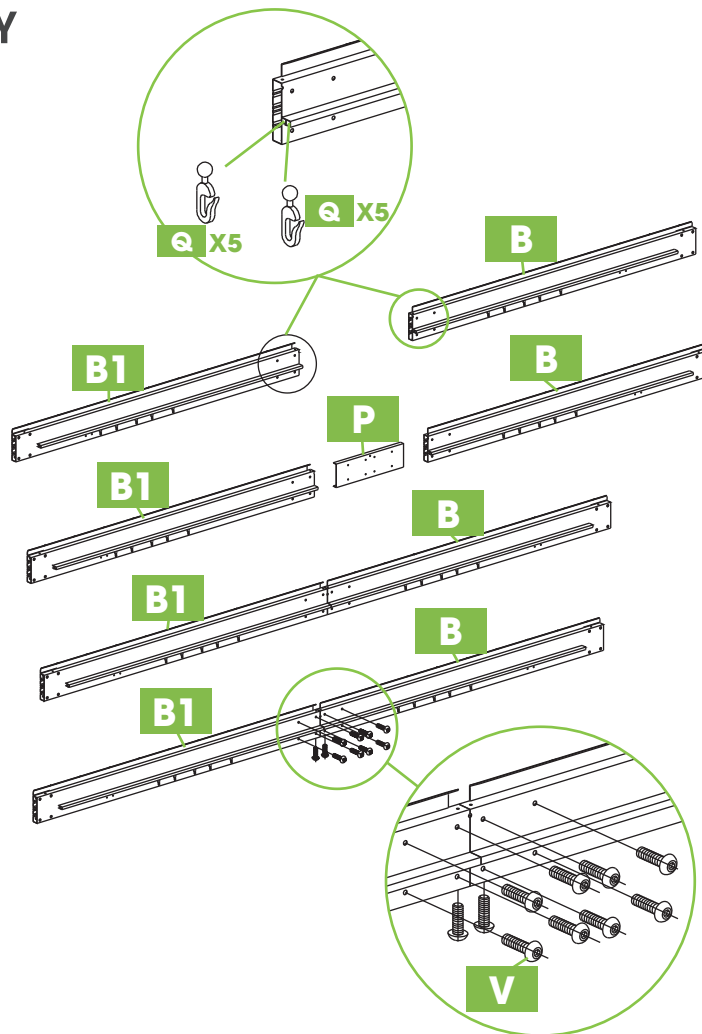

2

PART	NO.	QTY.
	B	2
	B1	2
	V	20
	P	2
	Q	40



PRODUCT ASSEMBLY

3

PART	NO.	QTY.
	C	2
	C1	2
	V	20
	P	2
	Q	56

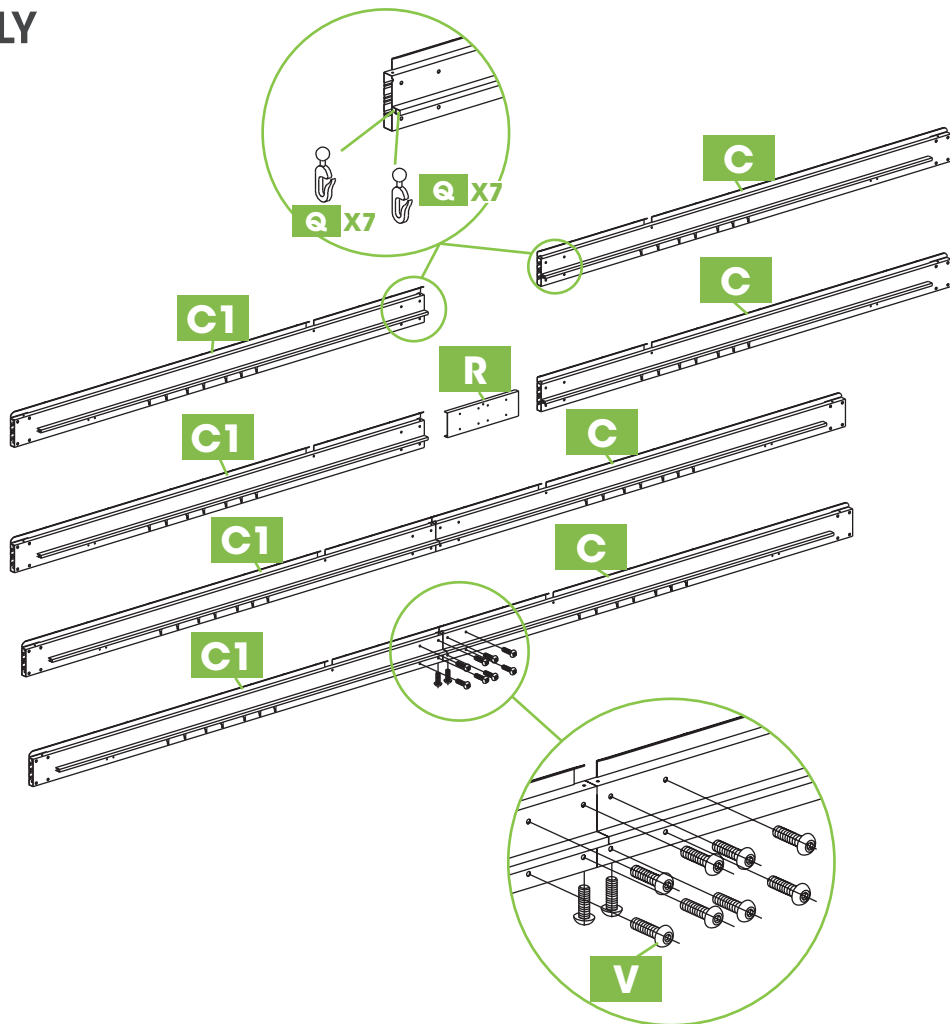

PRODUCT ASSEMBLY

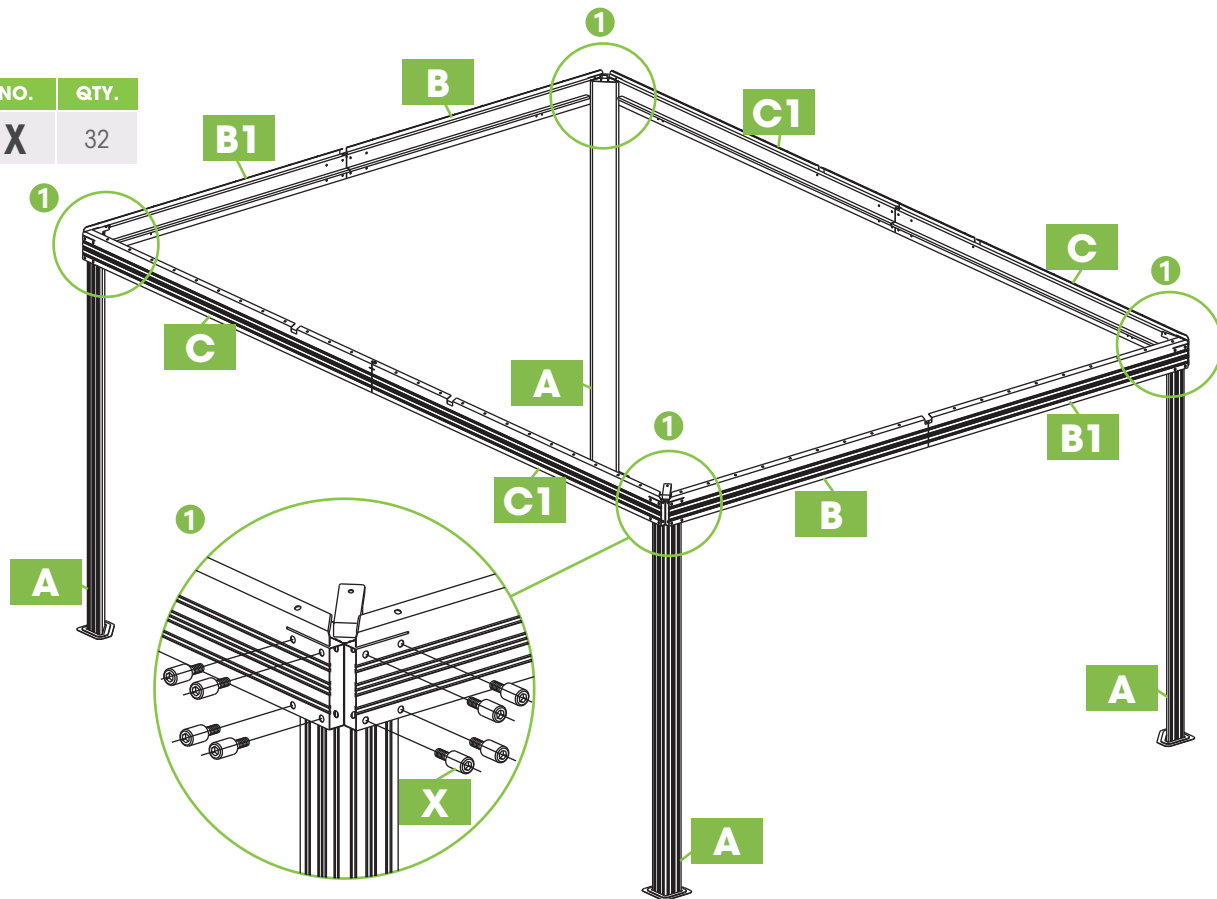

4

PART	NO.	QTY.
	X	32



I PRODUCT ASSEMBLY

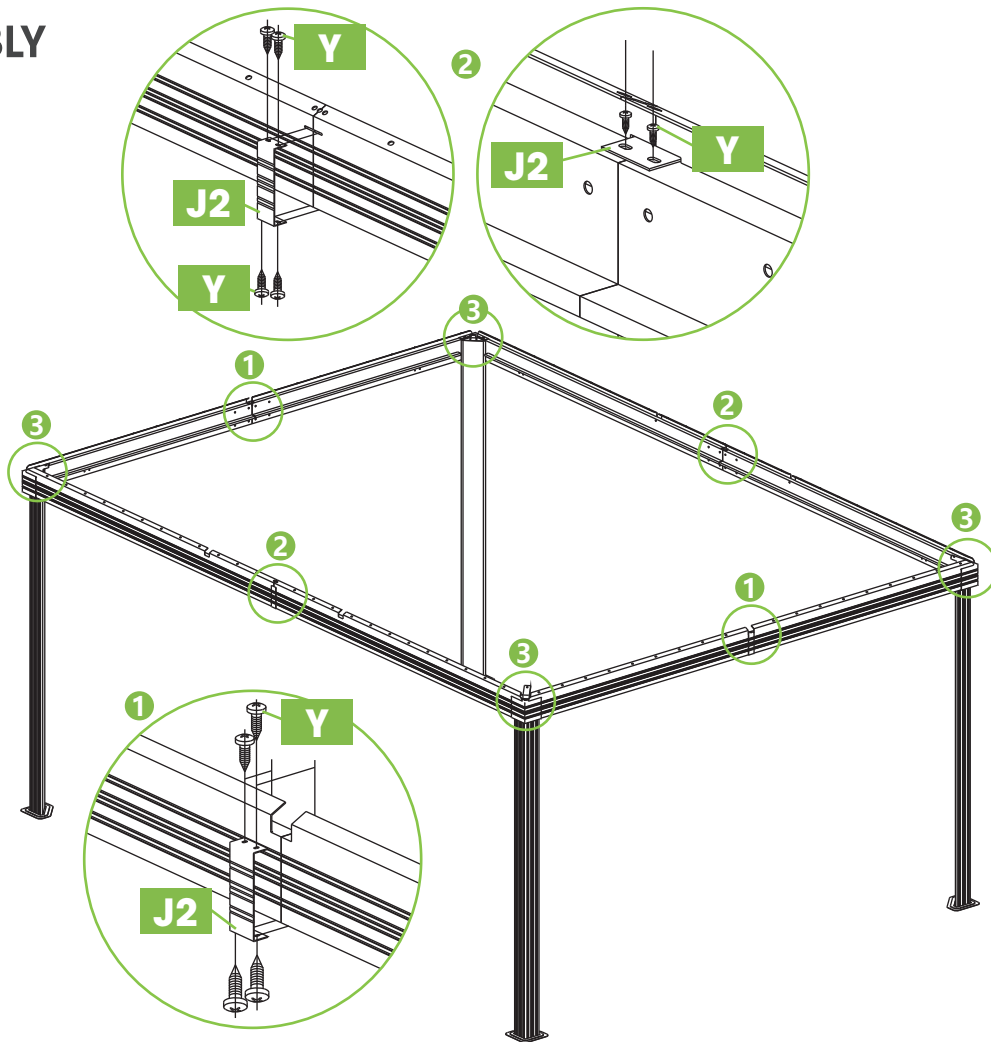
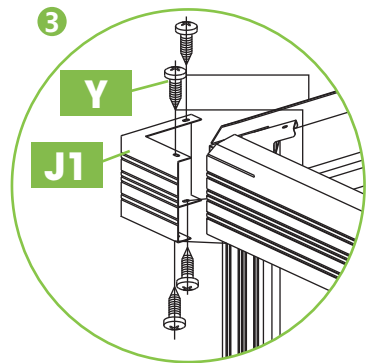

5

PART	NO.	QTY.
	J1	4
	J2	4
	Y	32



PRODUCT ASSEMBLY

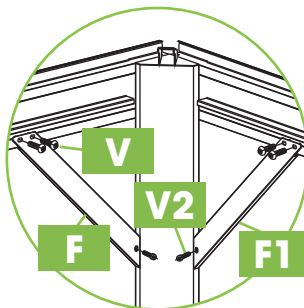
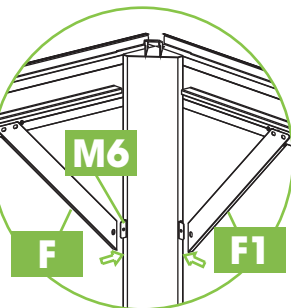
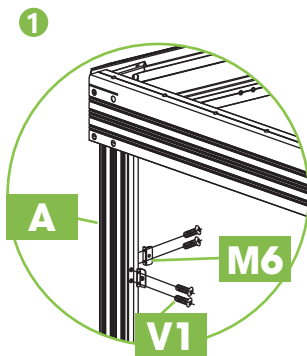
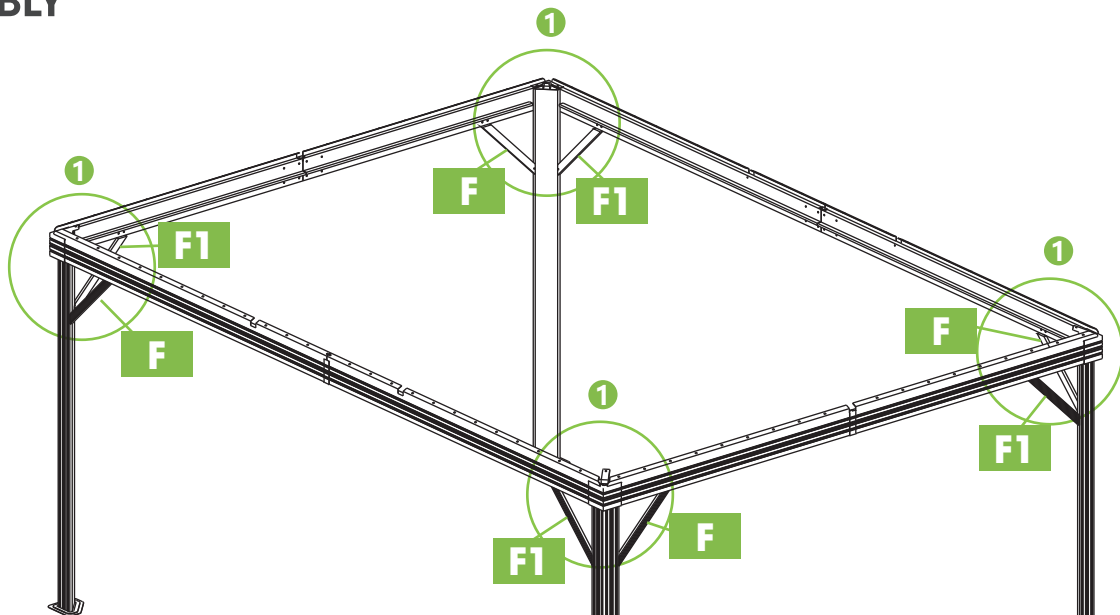

6

PART	NO.	QTY.
	F	4
	F1	4
	M6	8
	V1	16
	V	16
	V2	8



PRODUCT ASSEMBLY

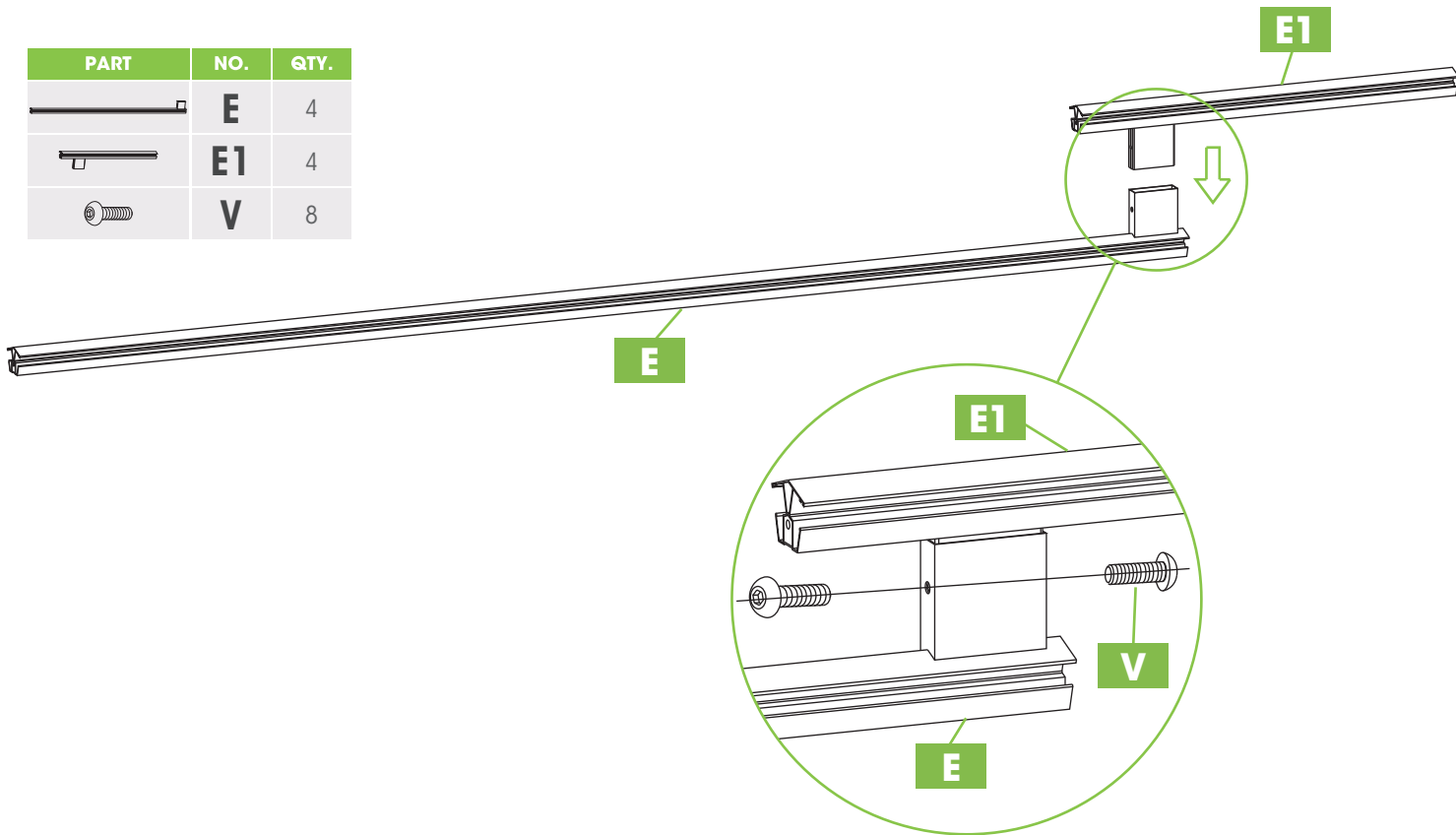

7

PART	NO.	QTY.
	E	4
	E1	4
	V	8



PRODUCT ASSEMBLY

8

PART	NO.	QTY.
	K1	1
	V	8

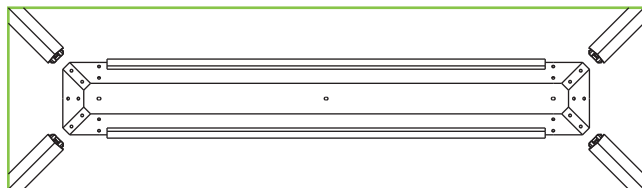
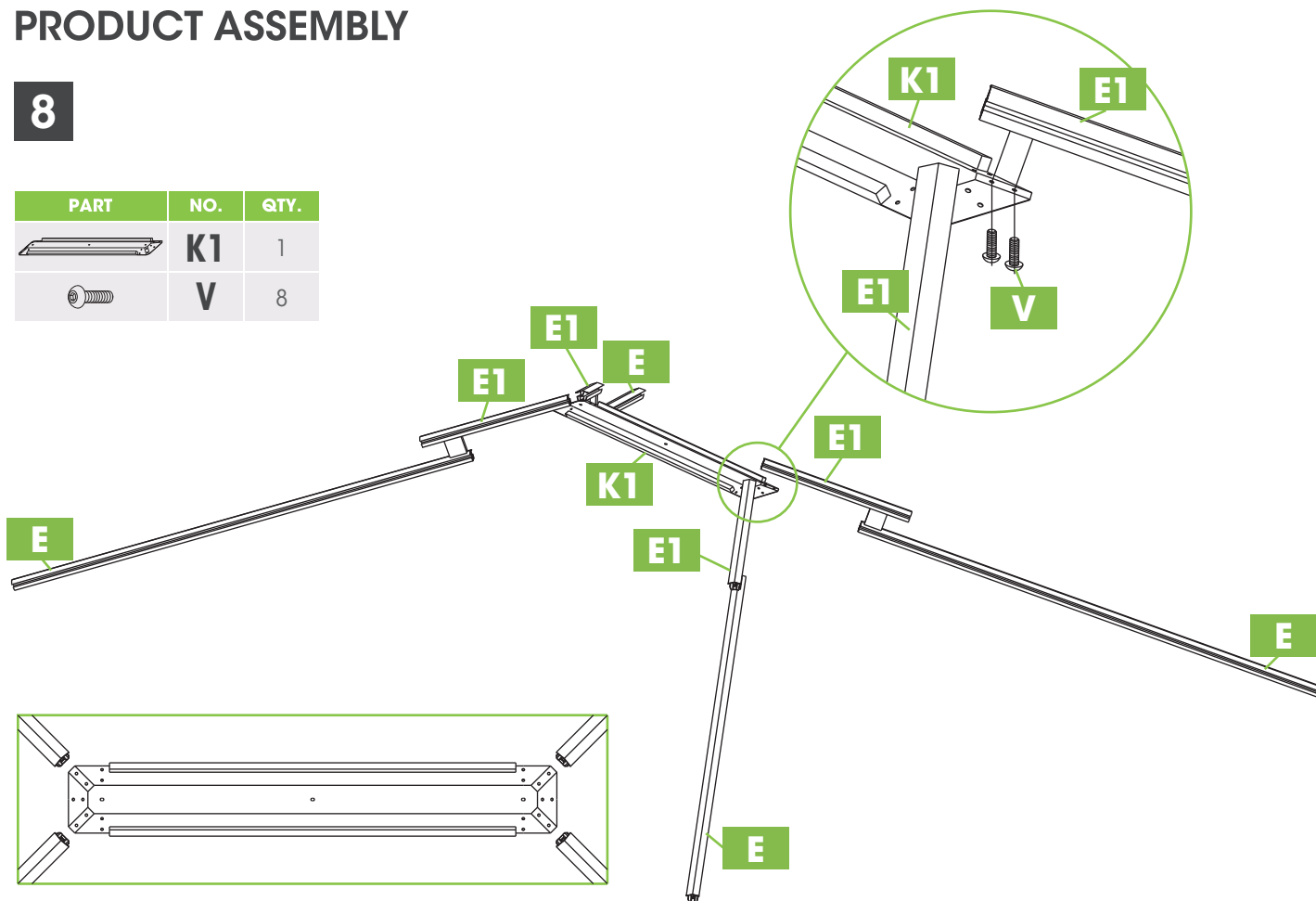

PRODUCT ASSEMBLY

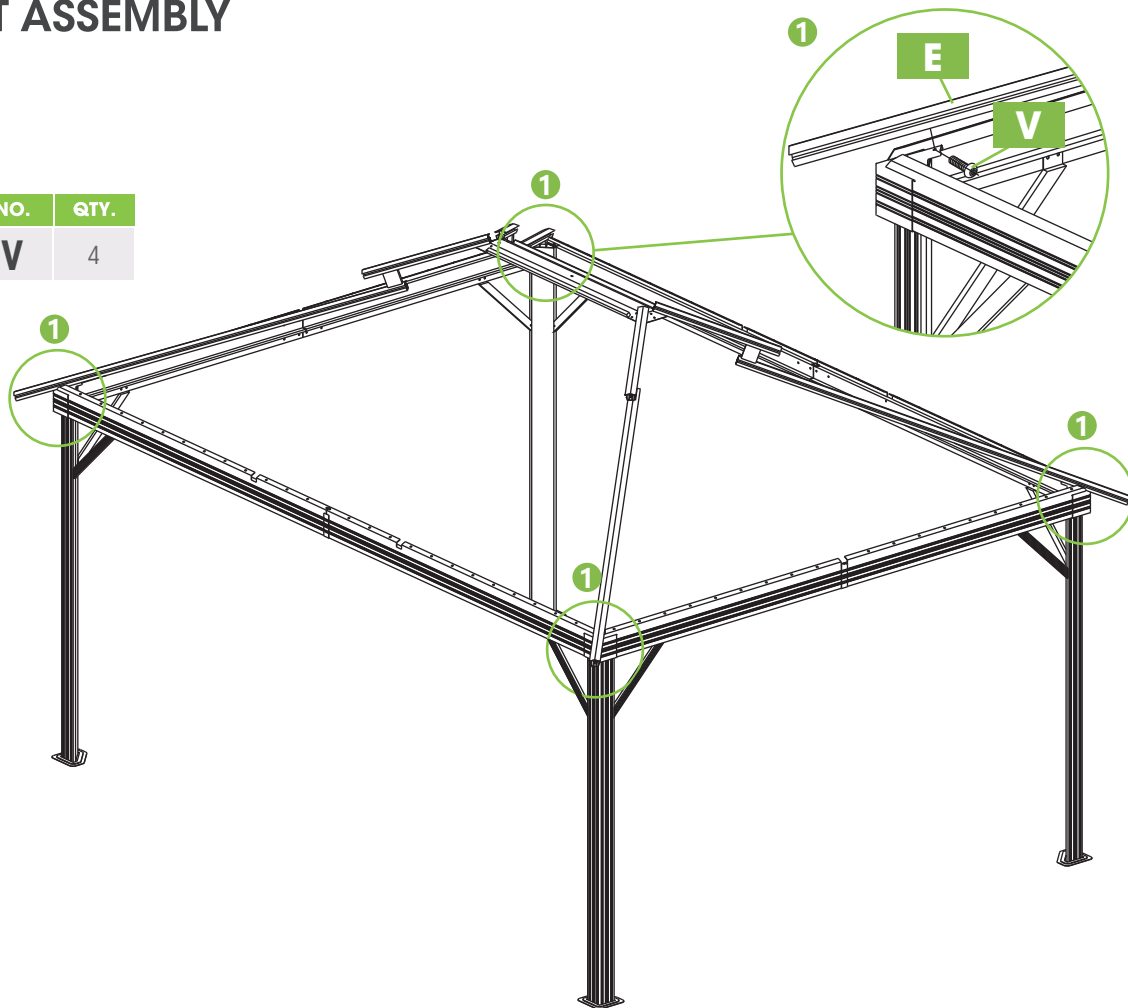

9

PART	NO.	QTY.
	V	4



PRODUCT ASSEMBLY



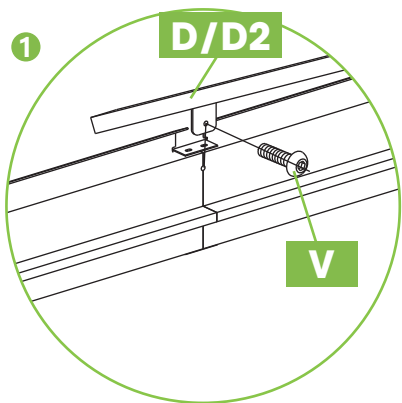
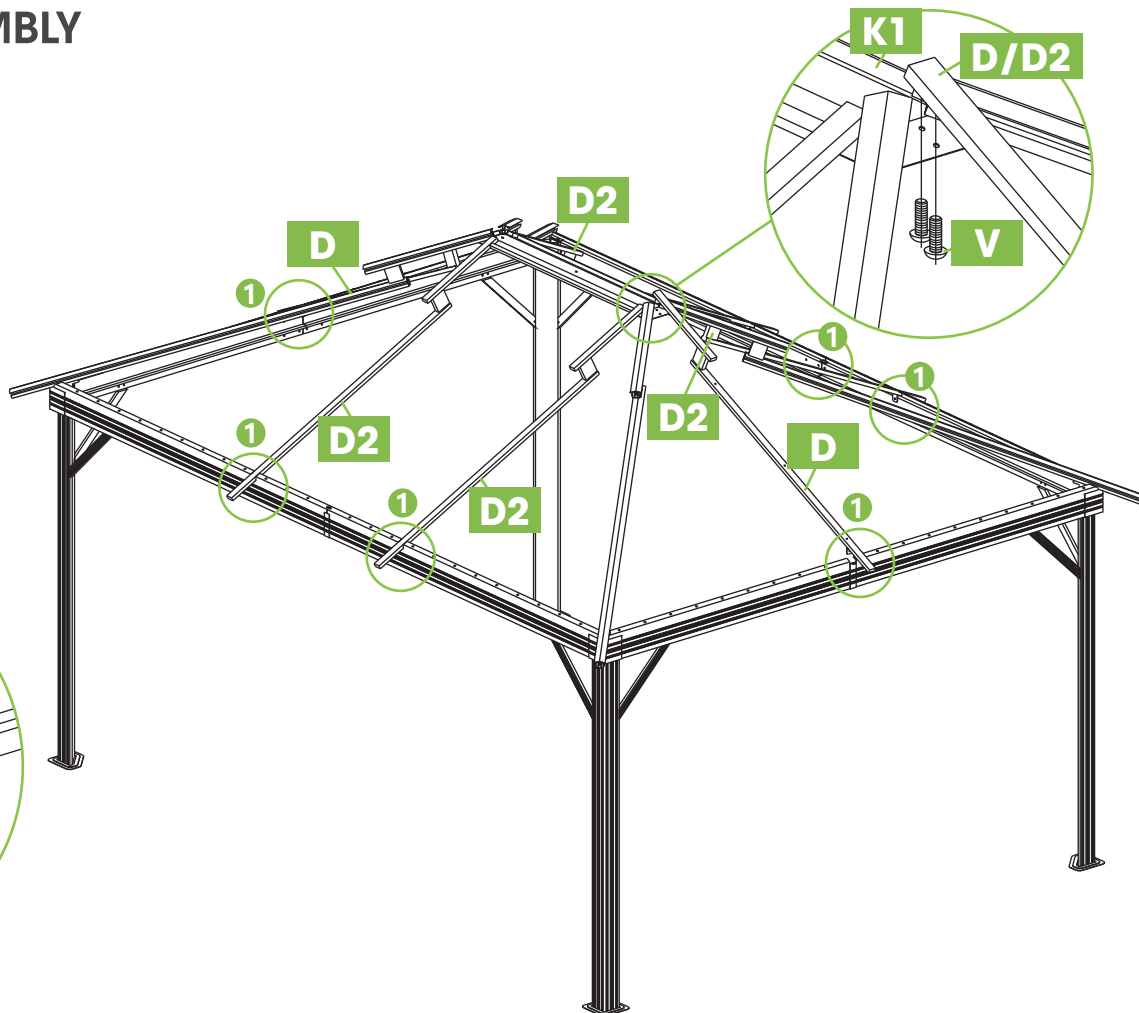

10

PART	NO.	QTY.
	D	2
	D2	4
	V	18



PRODUCT ASSEMBLY

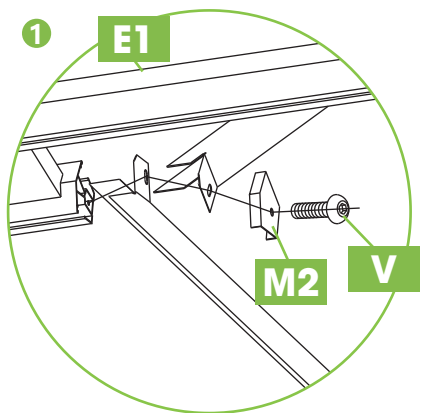
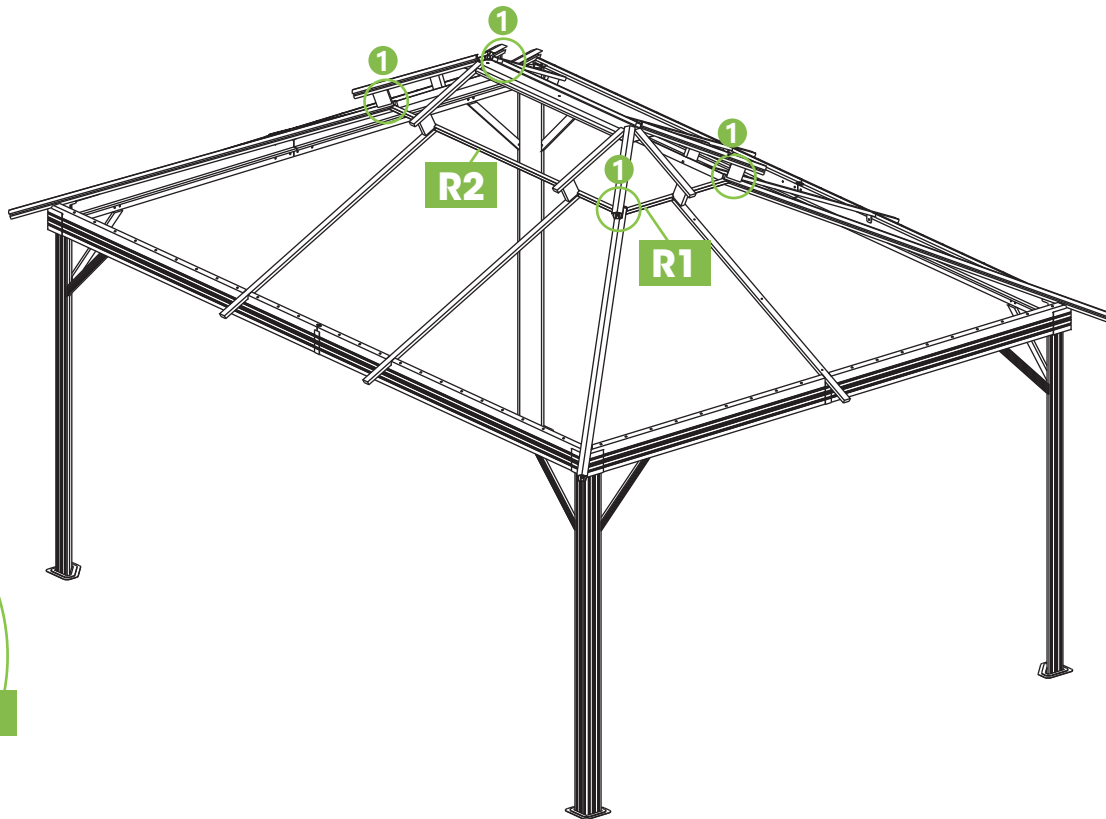

11

PART	NO.	QTY.
	R1	2
	R2	2
	M2	4
	V	4



PRODUCT ASSEMBLY

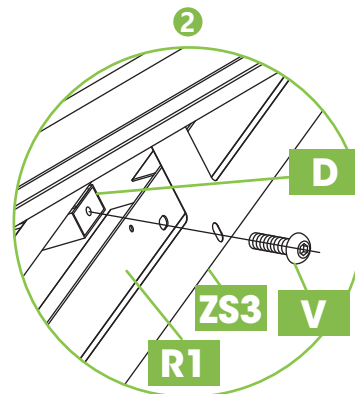
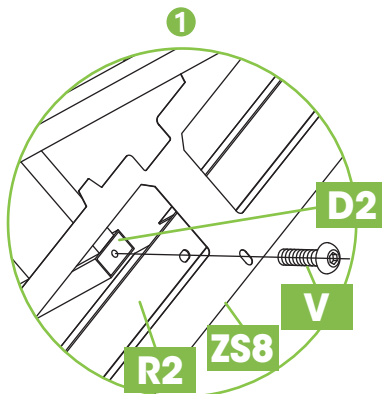
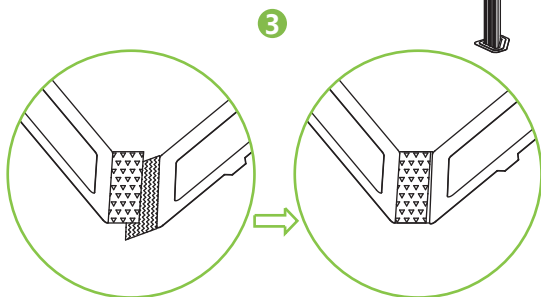
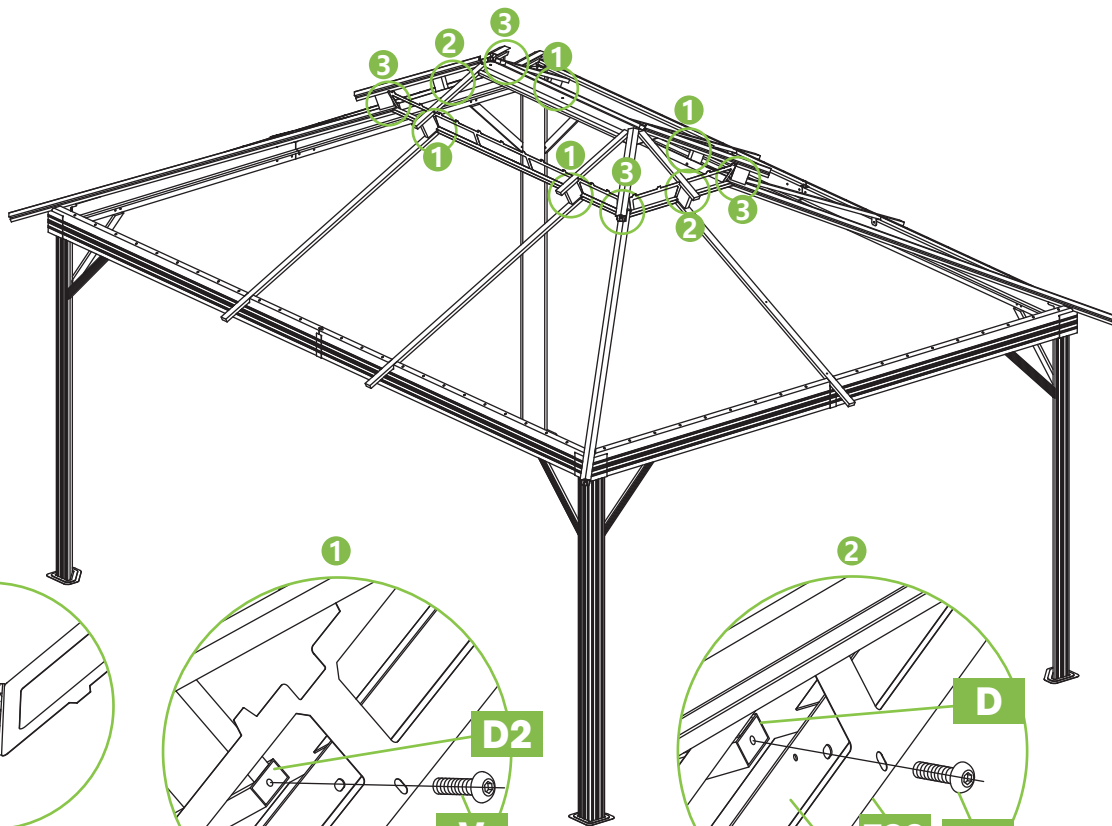

12

PART	NO.	QTY.
	ZS3	2
	ZS8	2
	V	6



PRODUCT ASSEMBLY



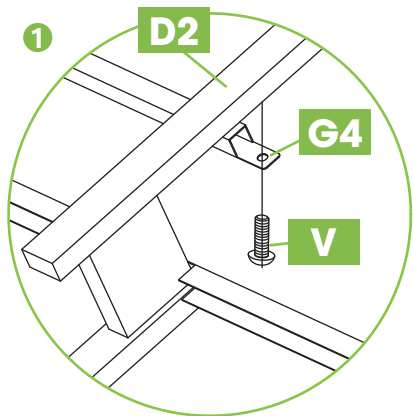
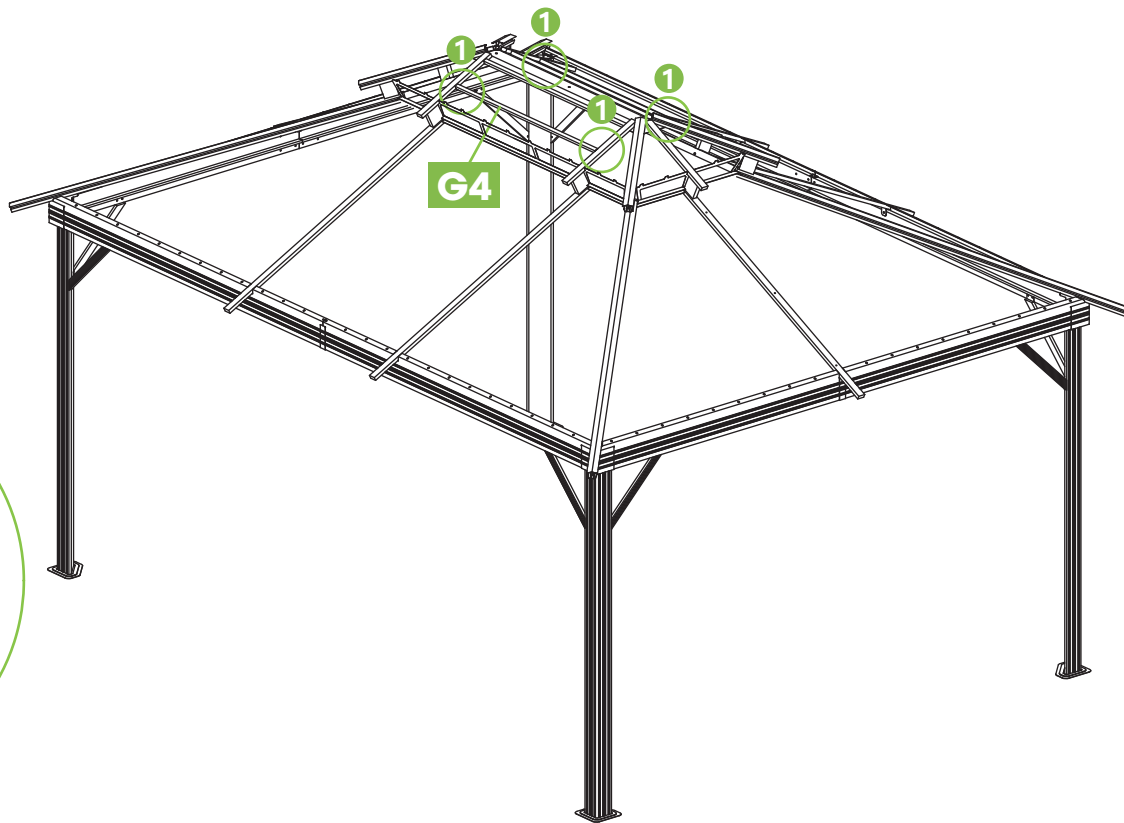

13

PART	NO.	QTY.
	G4	2
	V	4



PRODUCT ASSEMBLY





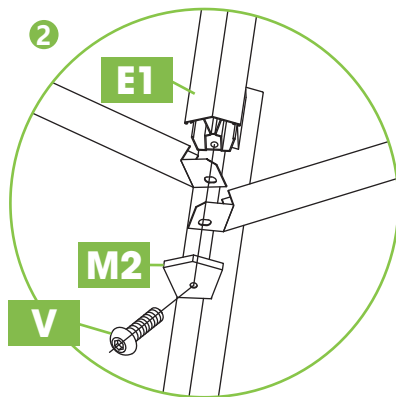
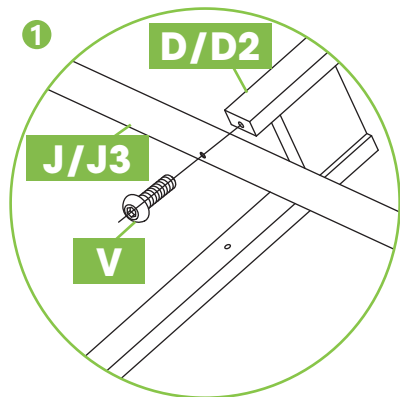
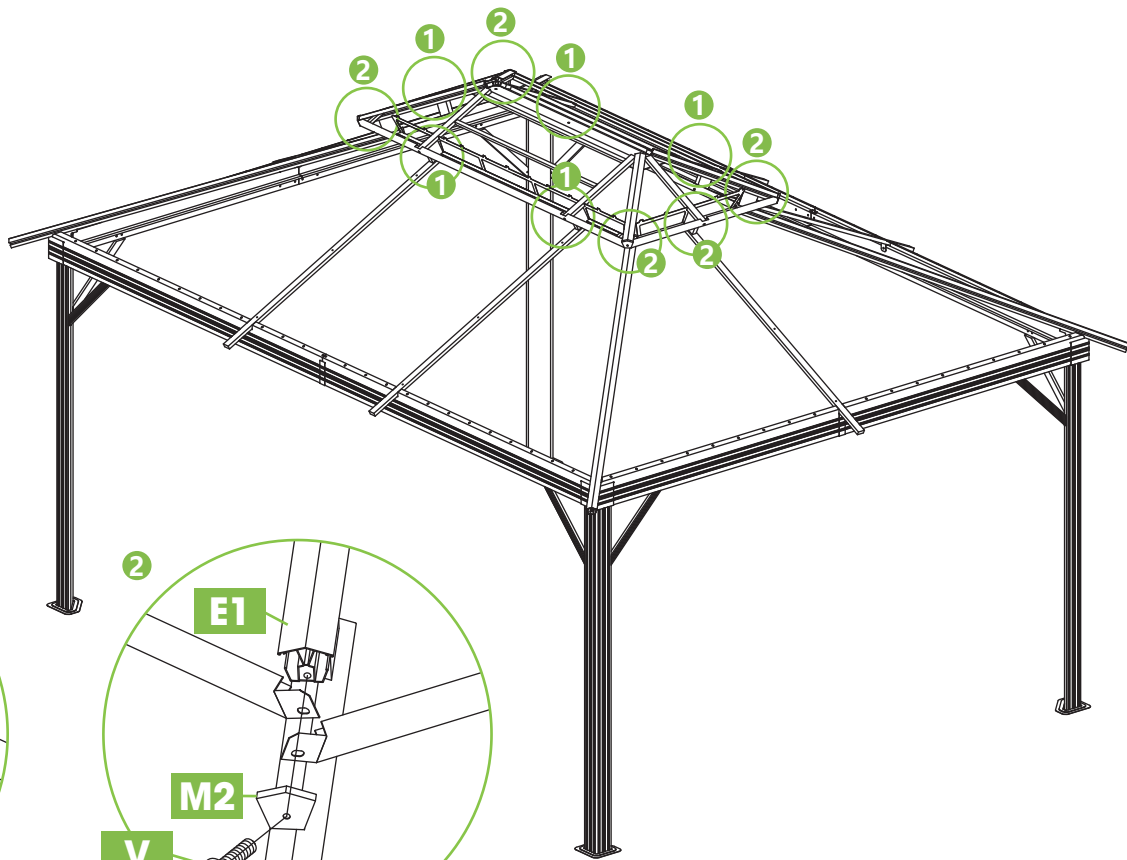



14

PART	NO.	QTY.
	J	2
	J3	2
	M2	4
	V	10



PRODUCT ASSEMBLY

15

PART	NO.	QTY.
	P	2
	P1	2
	P2	2
	P3	2
	P4	4
	P5	2
	P6	2
	R	12
	D1	8

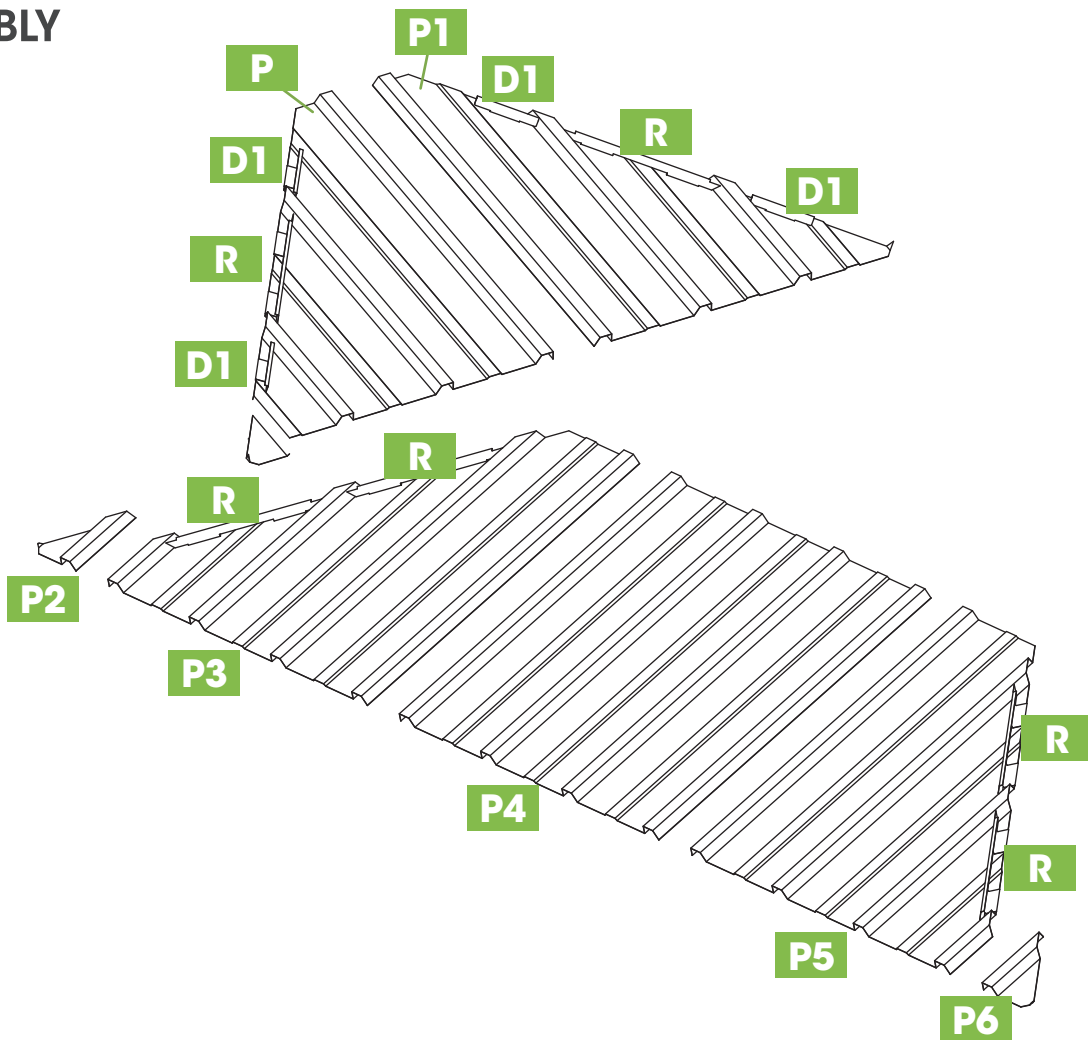

PRODUCT ASSEMBLY

16

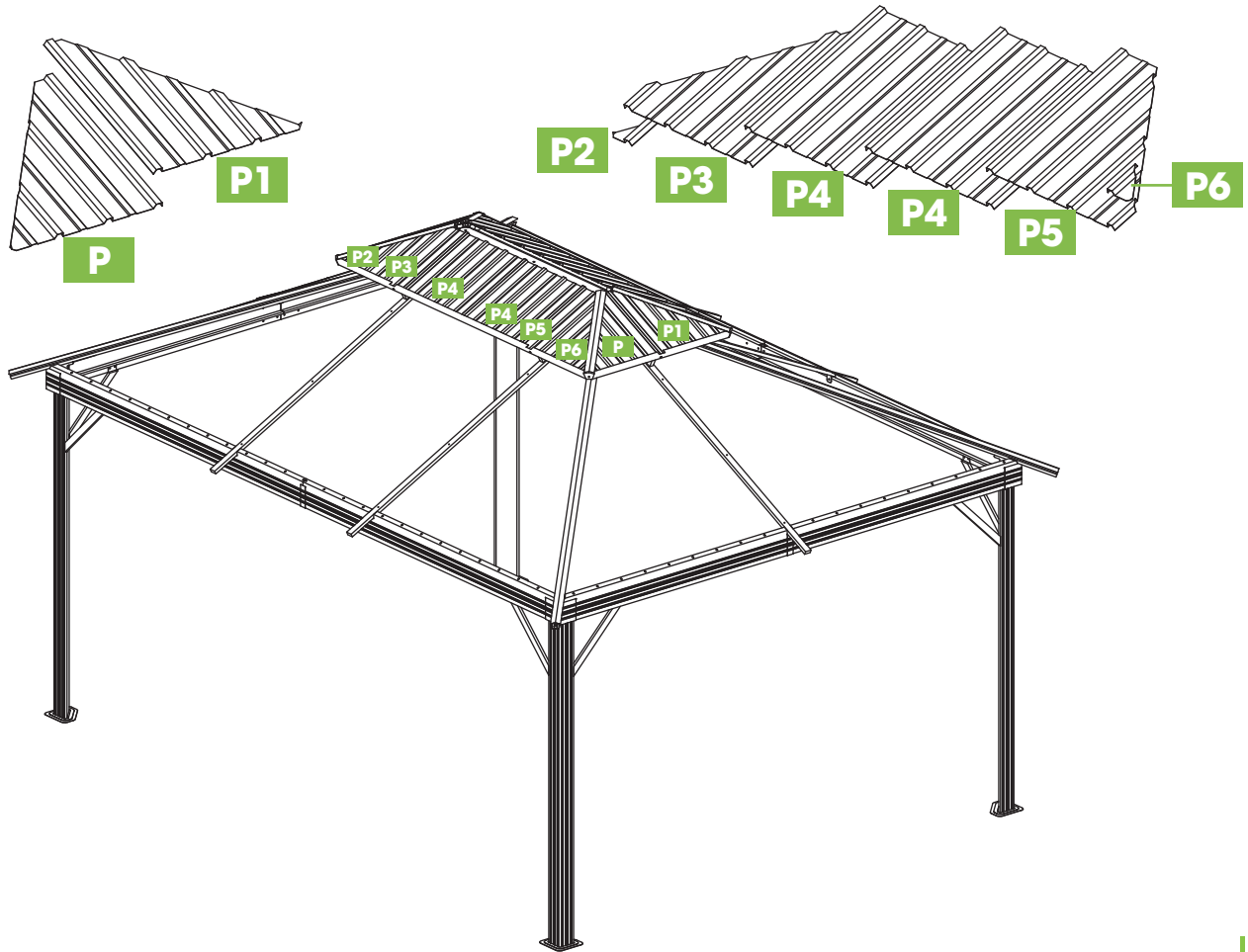

PRODUCT ASSEMBLY





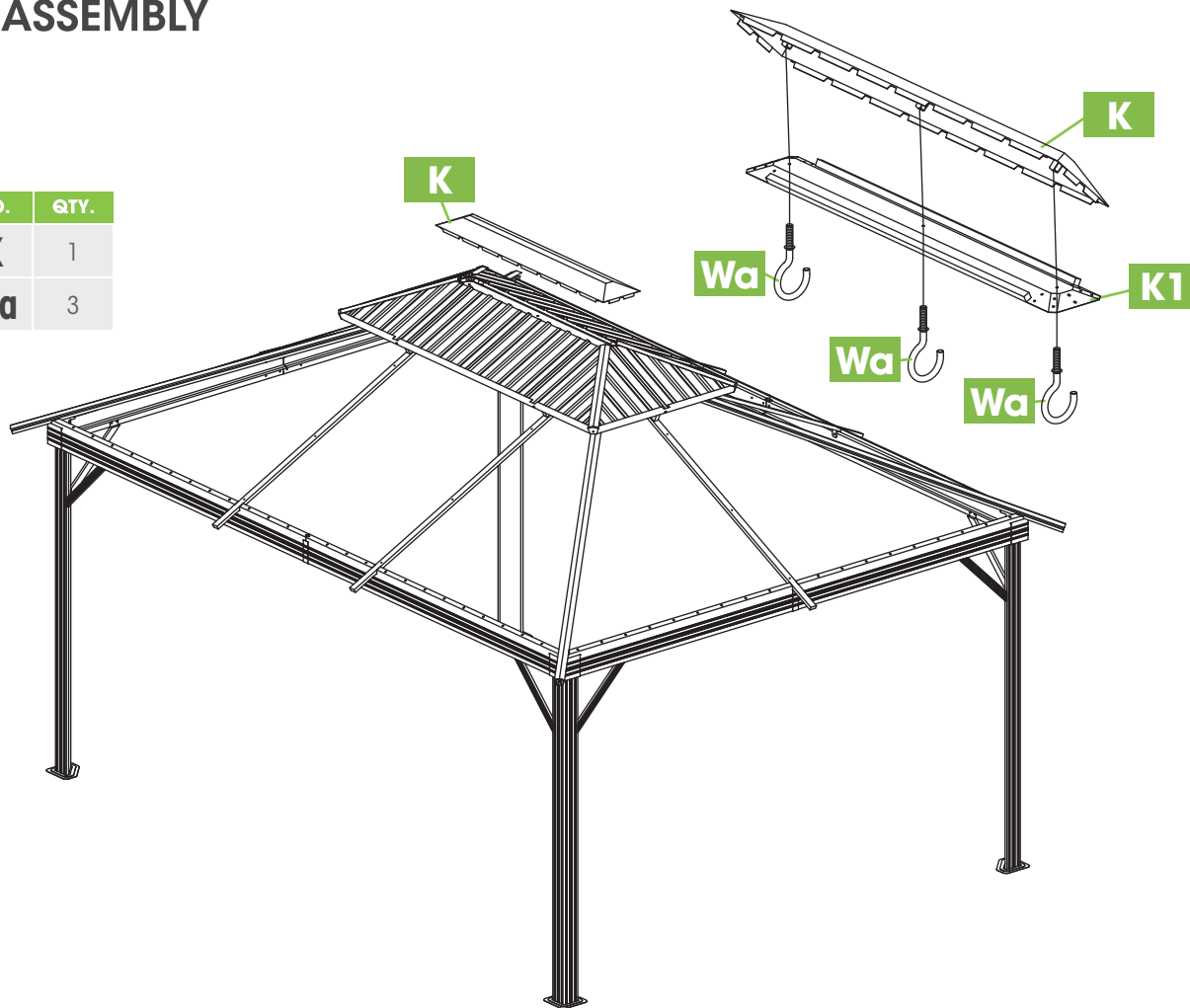

17

PART	NO.	QTY.
	K	1
	Wa	3



PRODUCT ASSEMBLY





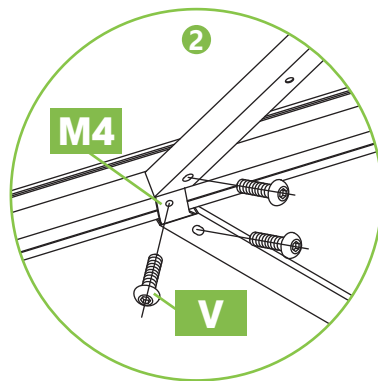
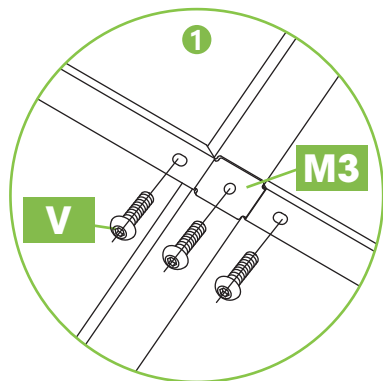
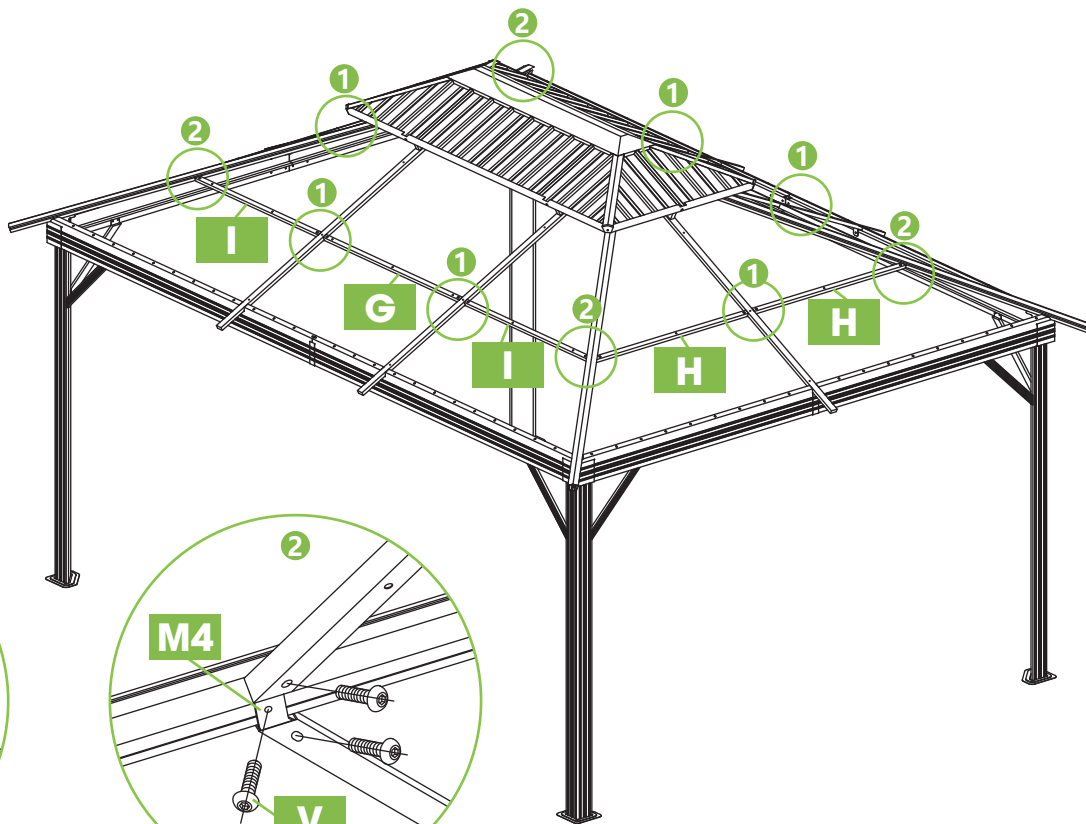









18





PART	NO.	QTY.
	H	4
	I	4
	G	2
	M3	6
	M4	4
	V	30



PRODUCT ASSEMBLY

19





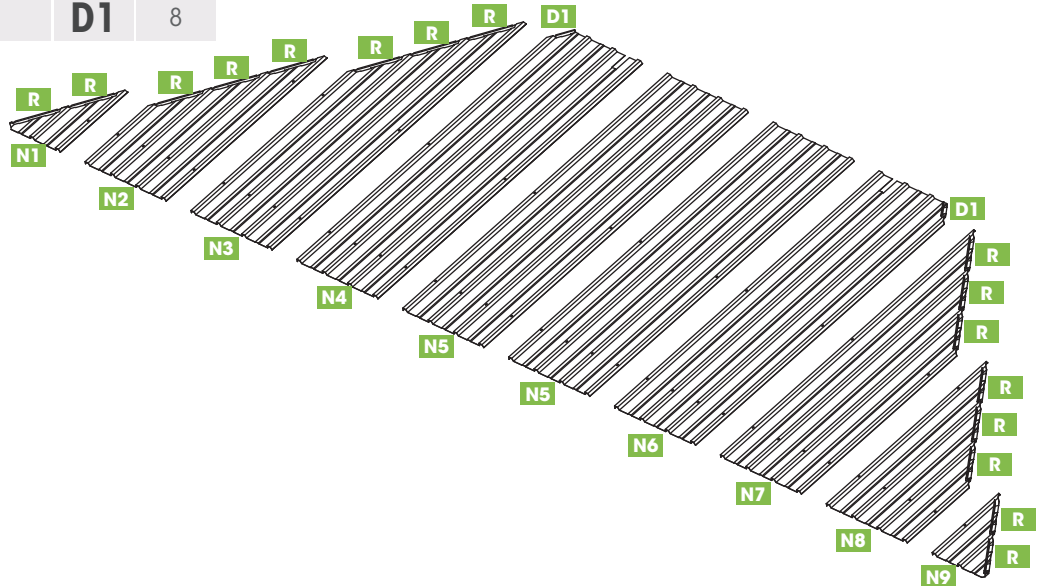
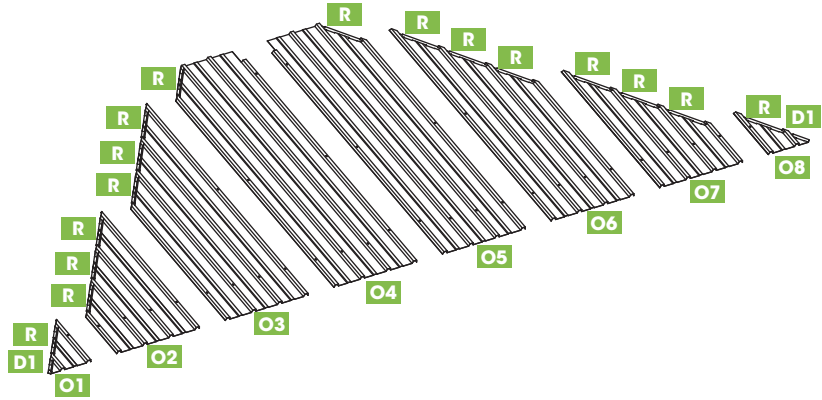

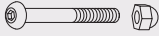

PART	NO.	QTY.
	N1	2
	N2	2
	N3	2
	N4	2
	N5	2
	N6	2
	N7	2
	N8	2
	N9	2
	O1	2
	O2	2
	O3	2
	O4	2
	O5	2

PART	NO.	QTY.
	O6	2
	O7	2
	O8	2
	R	64
	D1	8



PRODUCT ASSEMBLY

20

PART	NO.	QTY.
	S	2
	X1	4
	U	2
	T	18
	M5	26
	N5	4
	O4	2
	O5	2

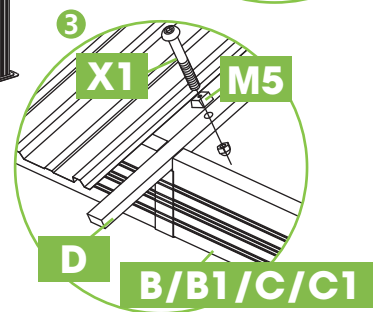
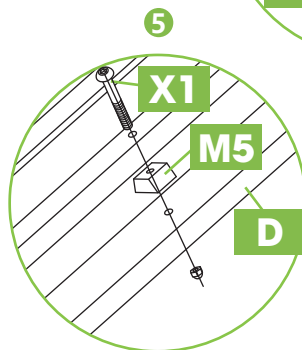
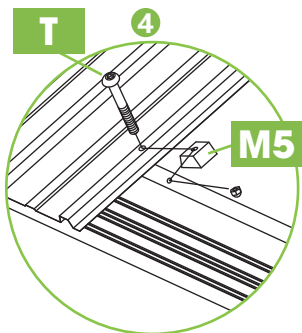
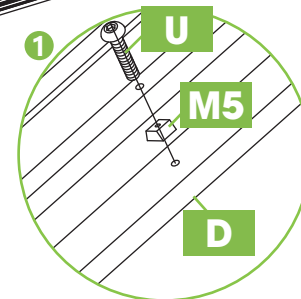
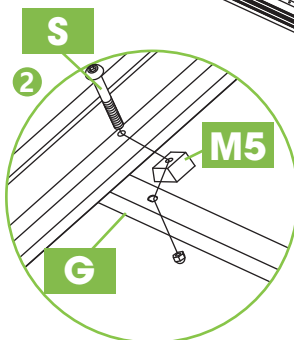
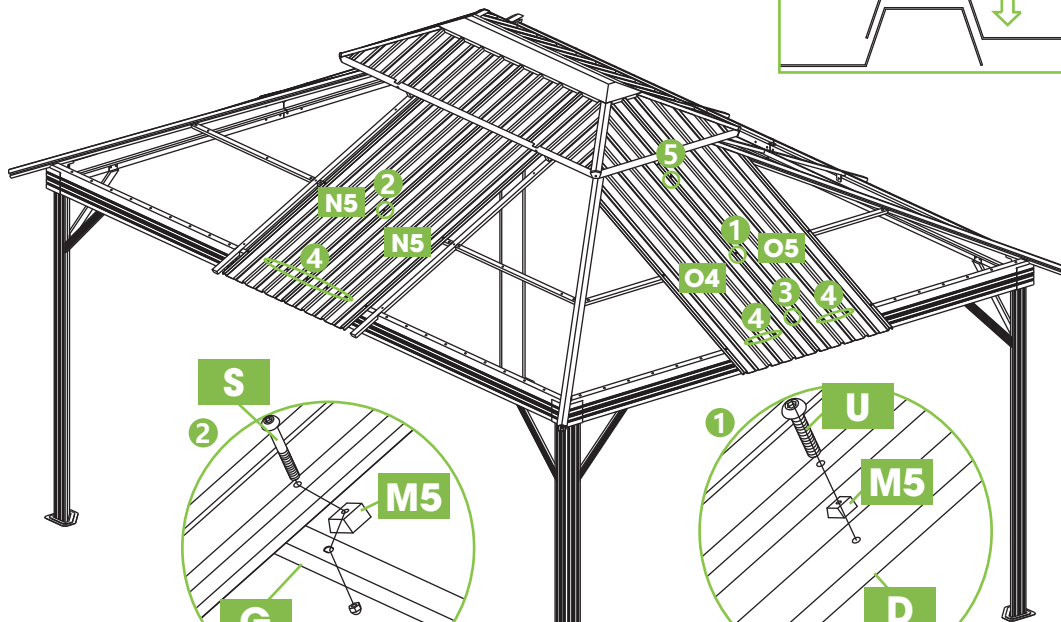

PRODUCT ASSEMBLY

21





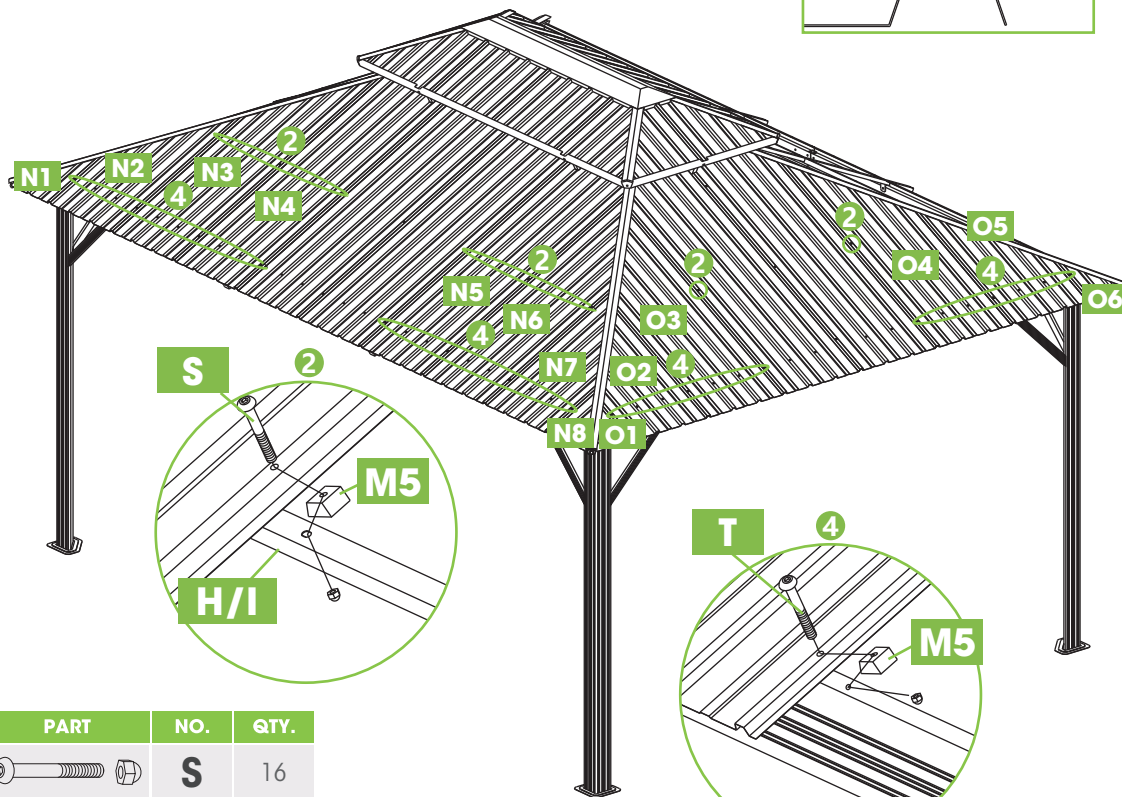



PART	NO.	QTY.
	01	2
	02	2
	03	2
	06	2
	07	2
	08	2
	N1	2
	N2	2
	N3	2
	N4	2
	N6	2
	N7	2
	N8	2
	N9	2



PART	NO.	QTY.
	S	16
	T	68
	M5	84

PRODUCT ASSEMBLY

22

PART	NO.	QTY.
	G1	4
	G2	4
	G3	2
	M1	6
	M2	4
	V	10

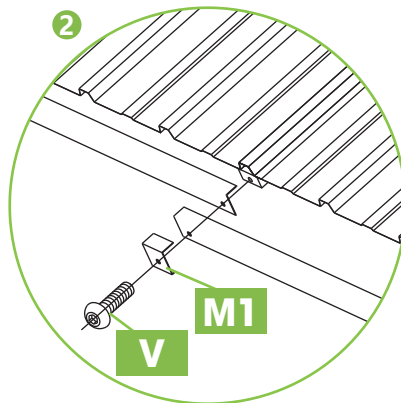
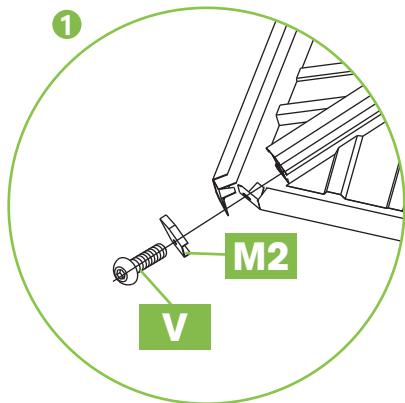
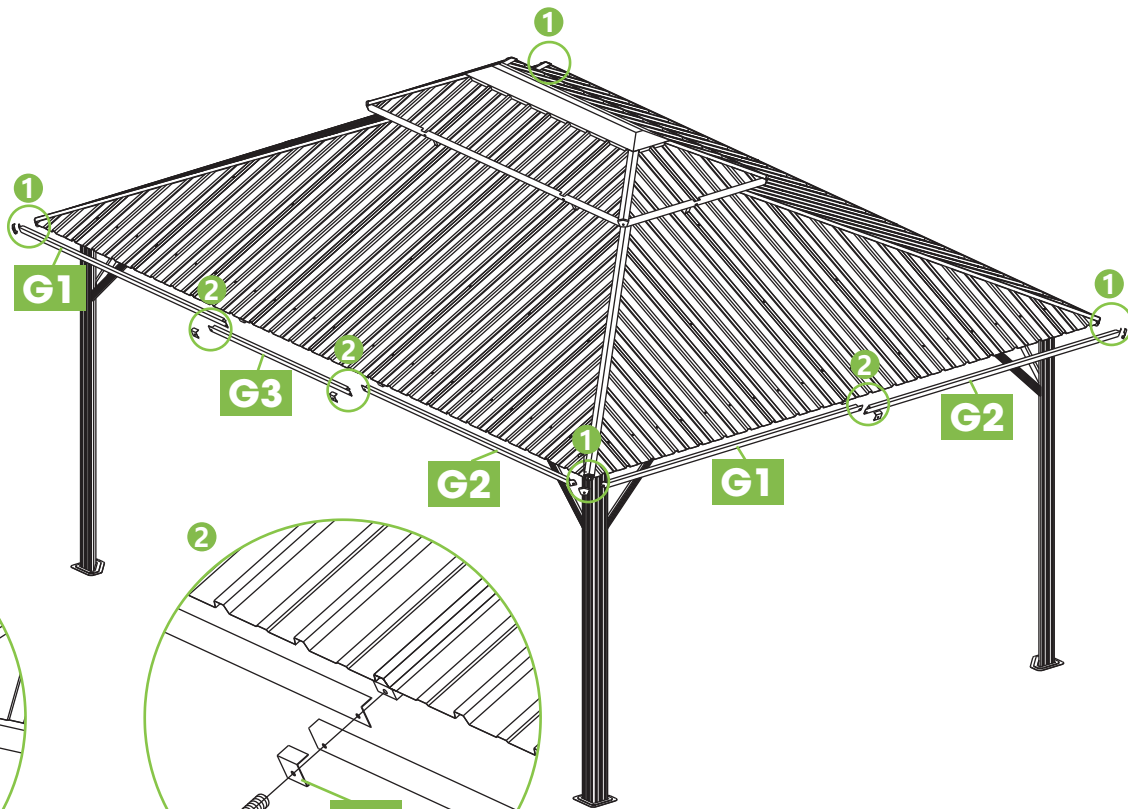

PRODUCT ASSEMBLY

23

PART	NO.	QTY.
	Wa	2

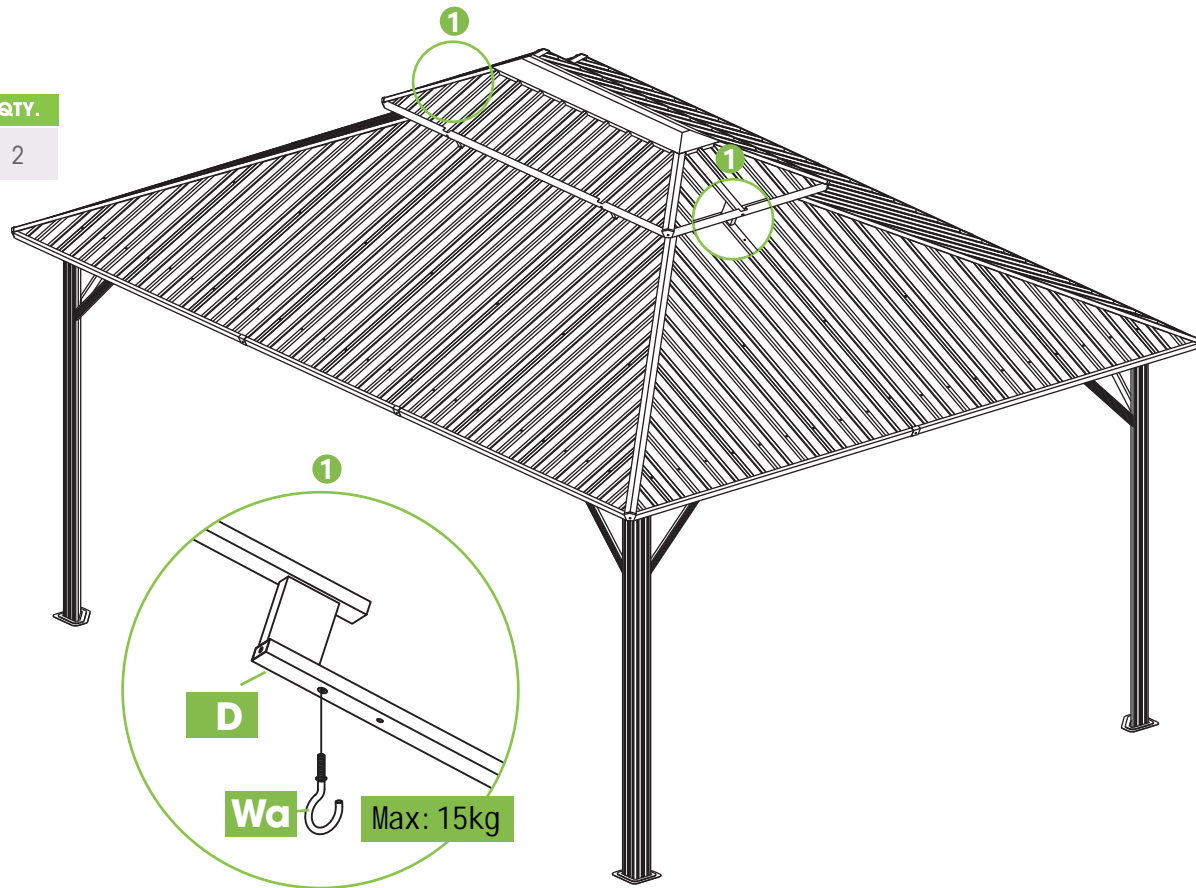

PRODUCT ASSEMBLY

24

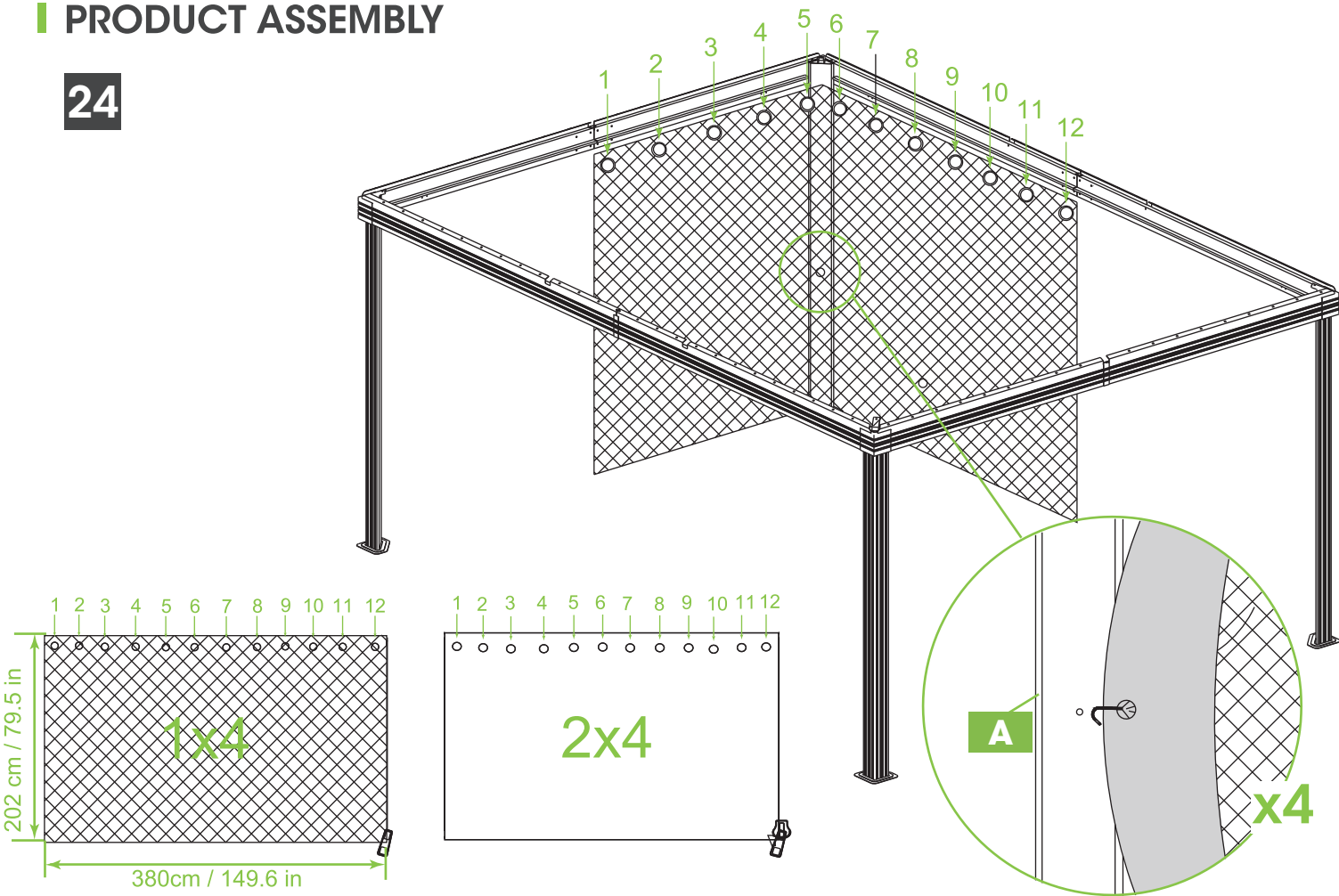

I PRODUCT ASSEMBLY

25

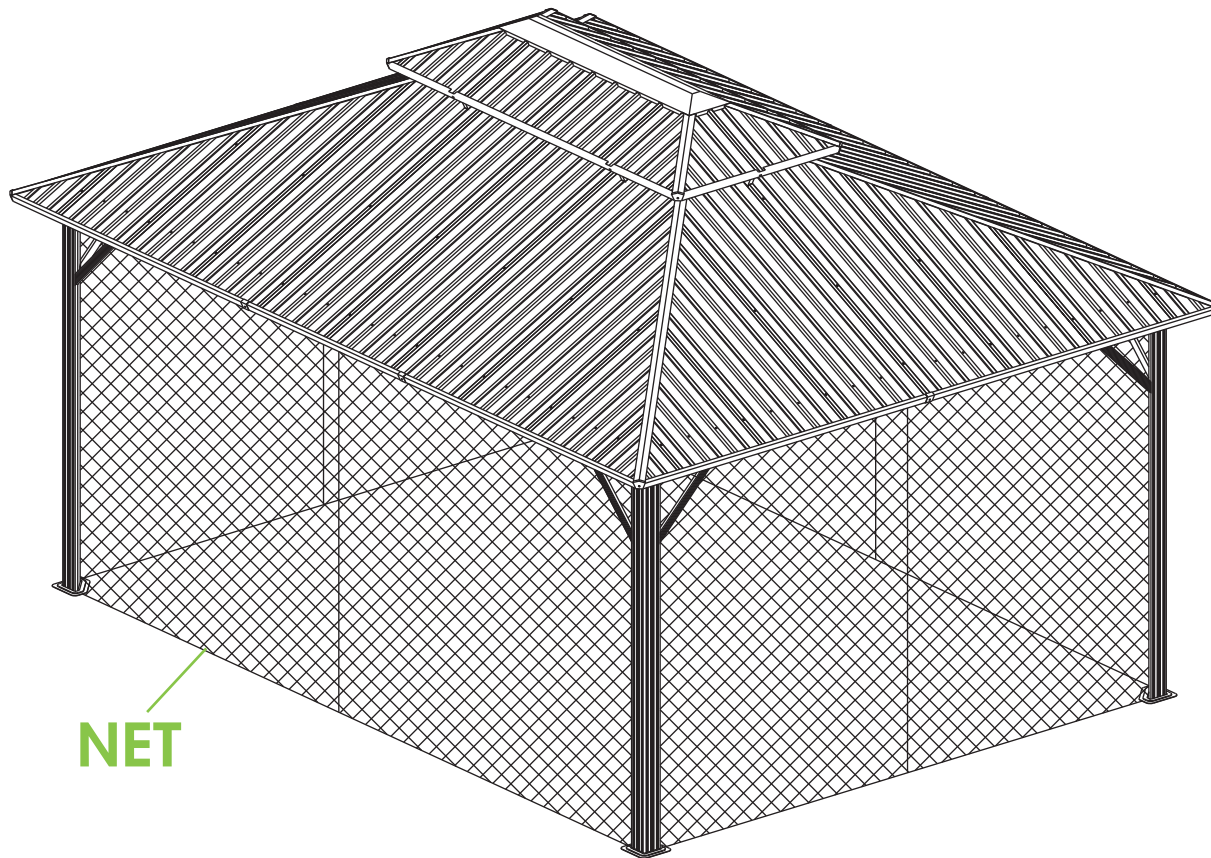

NET

PRODUCT ASSEMBLY

26

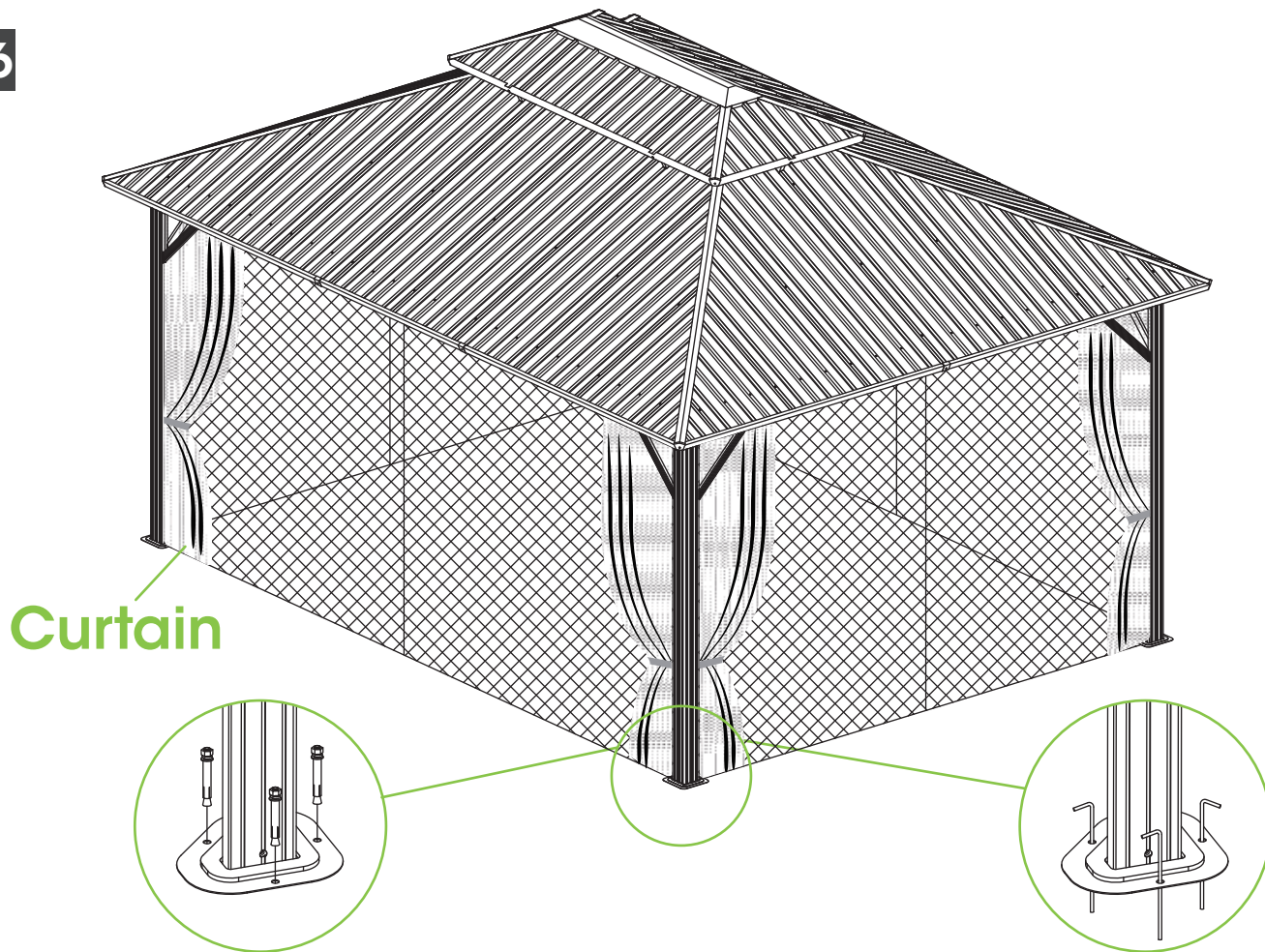

HELP CENTER

Question about your product? We're here to help. Visit us at:

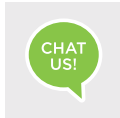

Chat Support

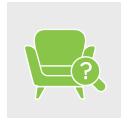

Product Inquiry

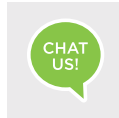

Orders FAQ



Product Assembly



Returns & Refunds

We Stand Behind the Quality of Their Furniture

If you have any issues with your item please let us know! We will always do our best to come up with a solution that you will be happy with. Please get in touch with our customer service team before returning the product. And pls do not throw the original box(es) if you have not finished assembling or confirmed no quality issues.

Length of return period:

Items can be returned within 30 days of purchase.

In the meanwhile, everything you purchased from us comes with a one-year warranty.

Who is responsible for the return shipping fee:

We will cover the return shipping fees if:

1. Your item has a manufacturing defect in its materials or workmanship. For example, torn wicker or misaligned screw holes. We will send you a prepaid shipping label after photos are sent.
2. Your item has been damaged in transit. For example, glass is broken or wicker is damaged. We will send you a prepaid shipping label after photos are sent.
3. You receive the wrong box(es) due to a warehouse error. We will send you a prepaid shipping label after photos are sent of the wrong SKU numbers on the outer box(es).
4. One or more boxes are lost in transit. We will send you a prepaid shipping label if you no longer want the item.

*However, we still hope to work with you for a better solution instead of a return. Please don't hesitate to contact our customer service team.

Customer will cover the return shipping fees if:

1. You don't like the product(s) after receiving the box(es).
2. You no longer need the product(s) but you have received the box(es).
3. You buy the product(s) by mistake but you have received the box(es).
4. Order/shipment cancellation failed and you have received the box(es).

Return Request

In order to get a full refund as described in this return policy, all items must be: (1) In a brandnew/unused condition, please provide photos before and after packaging.

(2) When returning, all accessories and parts are firmly packed in all original packaging.

If your return does not meet the requirements, you may not get a full refund.

When will I be refunded?

The refund is released once the goods have been returned to our warehouse.

What if the product is damaged/defective outside of the valid return period?

We want you to be a happy customer. Please reach out to us by email and we will come up with a solution to make sure you are satisfied.