

# Assembly Instructions

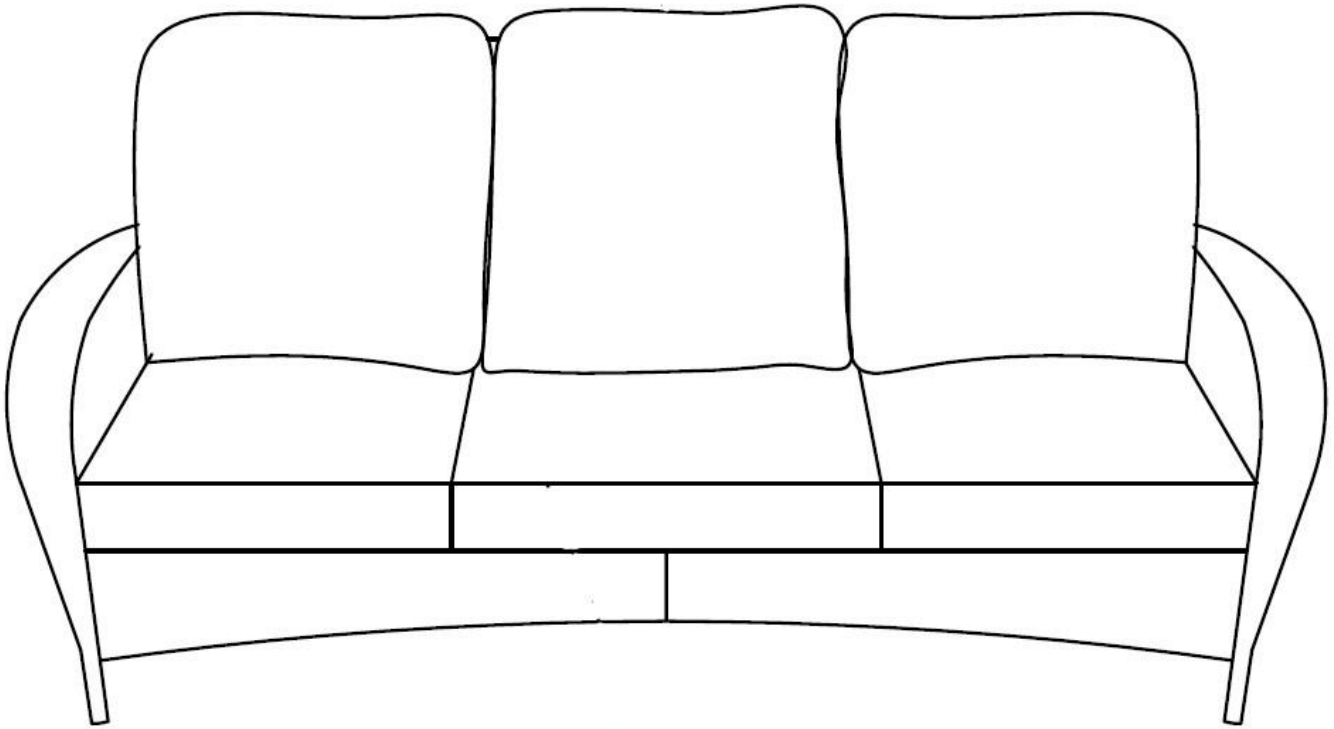











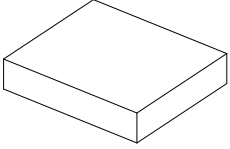

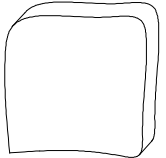
For any missing hardware, damaged parts and other problems.

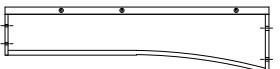
WELCOME to email us.

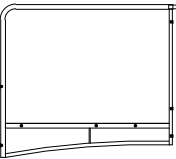
**\*Don't fully tighten all the bolts till the very end!**

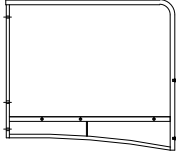

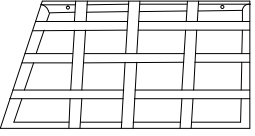
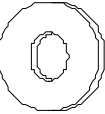
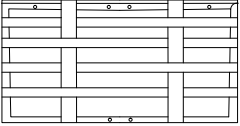
## PRE-ASSEMBLY PREPARATION:

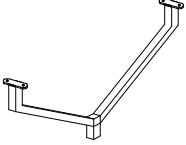
- Please read through the instructions before beginning assembly.
- Clear out the space for assembly and lay out all of the parts based on the Parts List, extra room will allow you to easily determine if all the pieces are present.
- Keep small parts and pieces away from children until fully assembled.

Part no.	Part	QTY	Image	Part no.	Part	QTY	Image
A1	Left arm	1		J	Seat cushion	3	
A2	Right arm	1		K	Back cushion	3	
C	Left front panel	1		L	Bolt (M6*15mm)	4	
D	Right front panel	1		M	Bolt (M6*30mm)	2	
E	Right back panel	1		N	Bolt (M6*35mm)	7	
F	Left back panel	1		O	Bolt (M6*45mm)	16	
G	Seat panel	2		P	Washer M6	29	
H	Seat middle panel	1		Q	Allen wrench	1	
I	Middle foot	1					

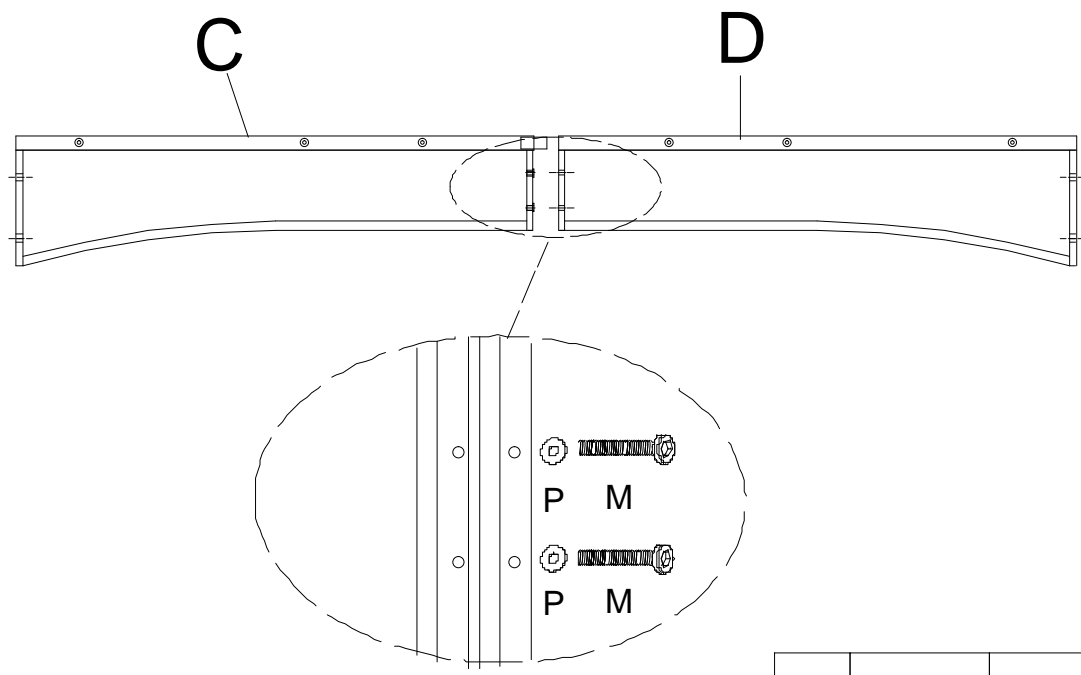
**Step 1:** Attach front panels C&D with 2pcs bolts M and 2pcs washers P, using Allen wrench Q. Note: Don't fully tighten the bolts.



M		M6*30	2
P		Ø16*Ø6.5*1	2

**Step 2:** Attach back E&F with 3pcs bolts N and 3pcs washers P, using Allen wrench Q. Note: Don't fully tighten the bolts.

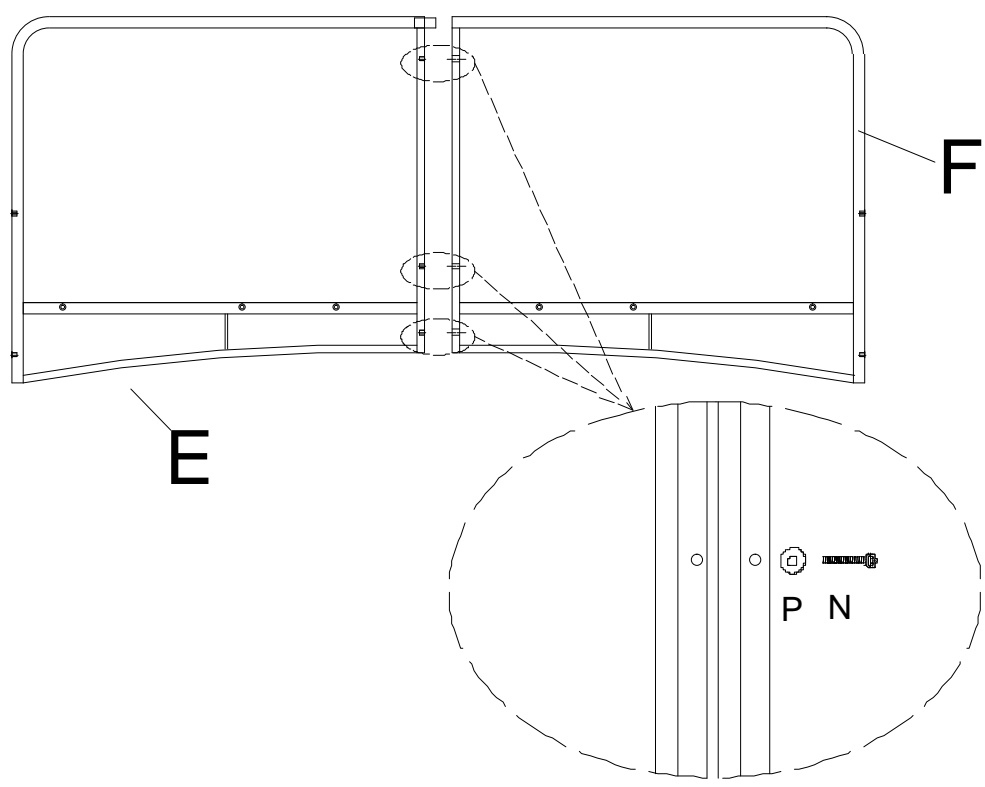



N		M6*35	3
P		Ø16*Ø6.5*1	3

**Step 3:** Attach arms A1&A2 to front panels C&D with 4pcs bolts N and 4pcs washers O, using Allen wrench Q. Note: Don't fully tighten the bolts.

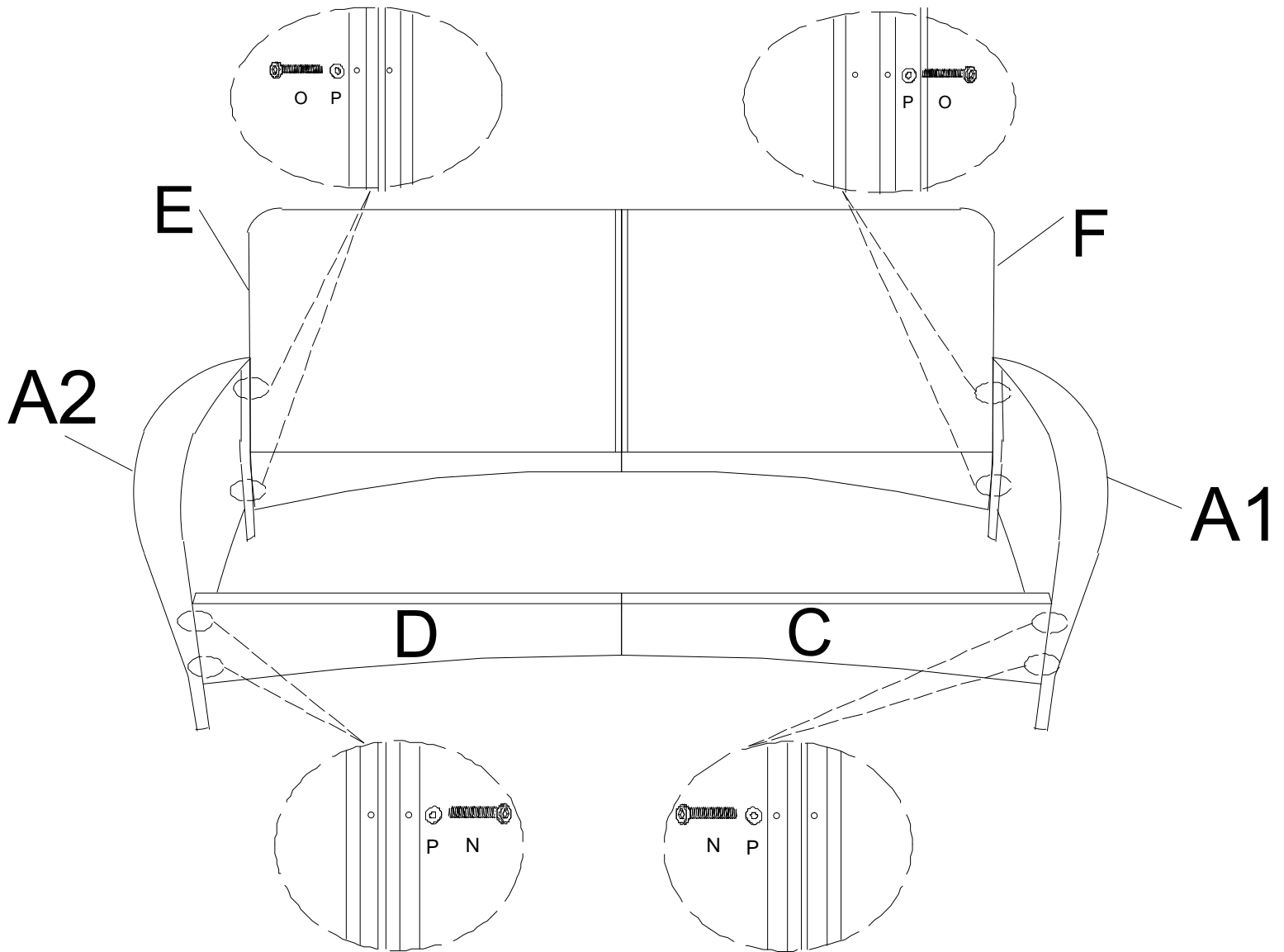
Attach arms A1&A2 to back panels E&F with 4pcs bolts O and 4pcs washers P, using Allen wrench Q. Note: Don't fully tighten the bolts.





N		M6*35	4
O		M6*45	4
P		Ø16*Ø6.5*1	8

**Step 4:** Attach seat panels G&H to front panels C&D with 6pcs bolts O and 6pcs washers P, using Allen wrench Q. Note: Don't fully tighten the bolts.

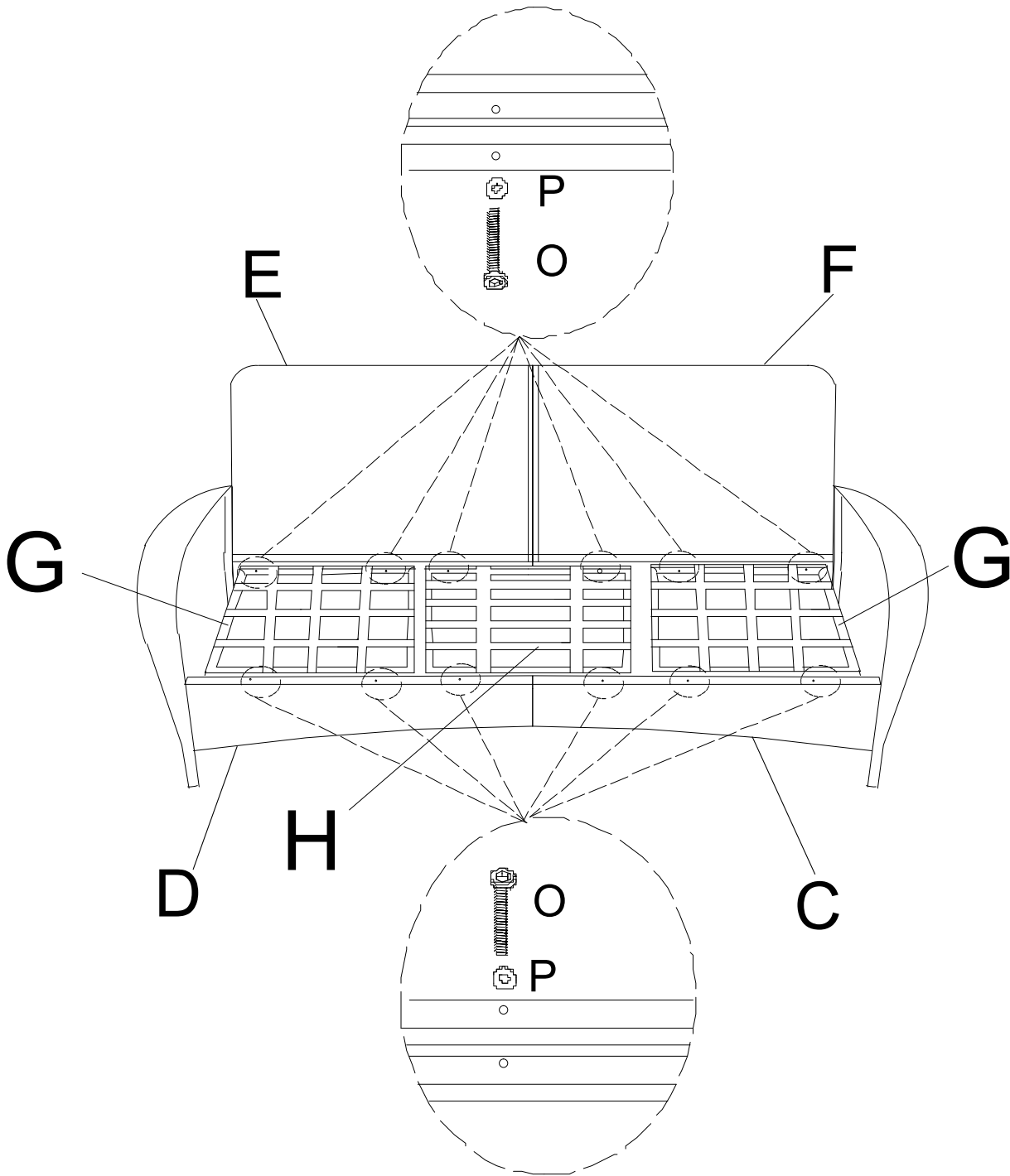

Attach seat panels G&H to back panels E&F with 6pcs bolts O and 6pcs washers P, using Allen wrench Q. Note: Don't fully tighten the bolts.

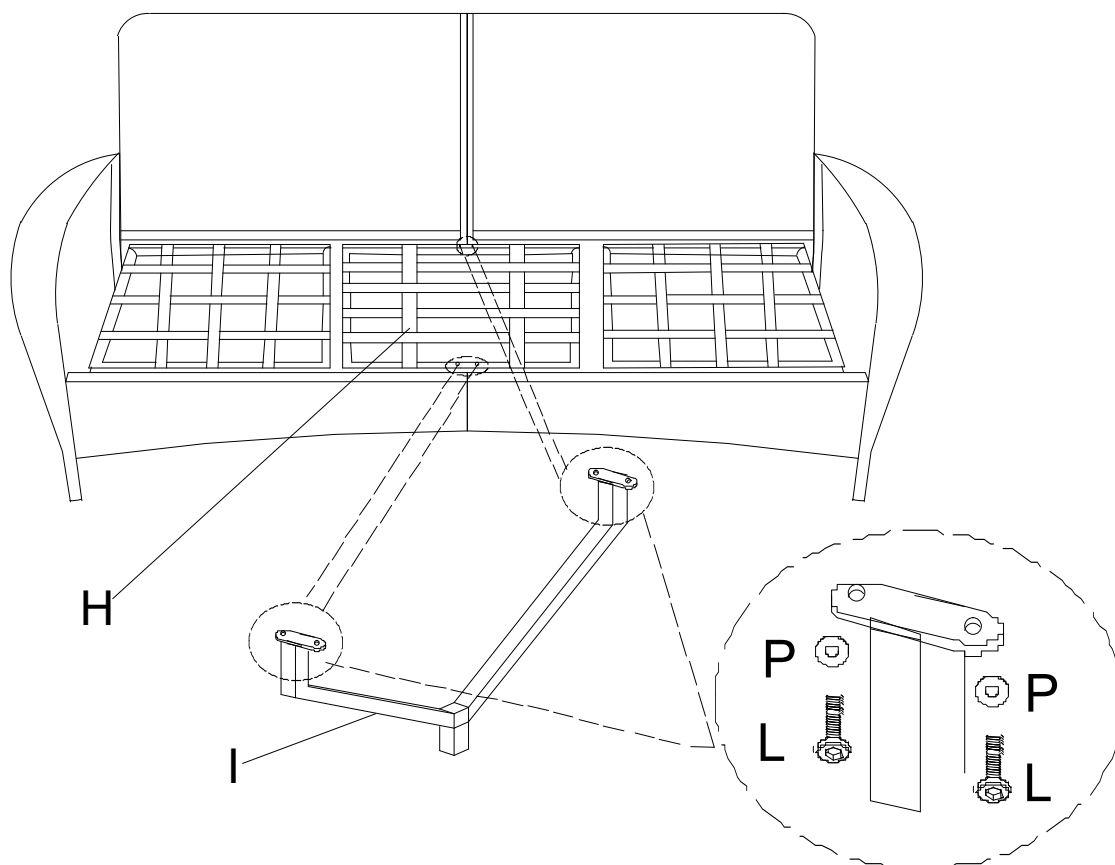

O		M6*45	12
P		Ø16*Ø6.5*1	12

**Step 5:** Attach middle foot I to middle seat panel H with 4pcs bolts L and 4pcs washers P, using Allen wrench Q. Note: Please fully tighten all the bolts.



L		M6*15	4
P		Ø16*Ø6.5*1	4

**Step 6:** Put seat cushions J and back cushion K onto the seat .  
Assembly is now complete and the product is ready for use.

