









# Installation Instruction

## Part List and Hardware List

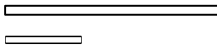
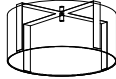
ITEM	PICTURE	DESCRIPTION	QUANTITY	ITEM	PICTURE	DESCRIPTION	QUANTITY	
A		Mounting Bracket	X1	J				
B		Self-tapping Screws	X2	K				
C		Canopy	X1	L				
D		M4 Nuts	X2	M				
E		Downrods	15.7"X3 5.9"X1	N				
F		Fabric Lampshade	X1	O		Wire connectors	X3	
				P		black	Line Wire	X1
H		Lamp Body	X1	Q		white	Neutral Wire	X1
				R		Earth	Ground wire	X1

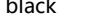
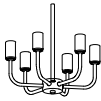
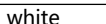
**1**

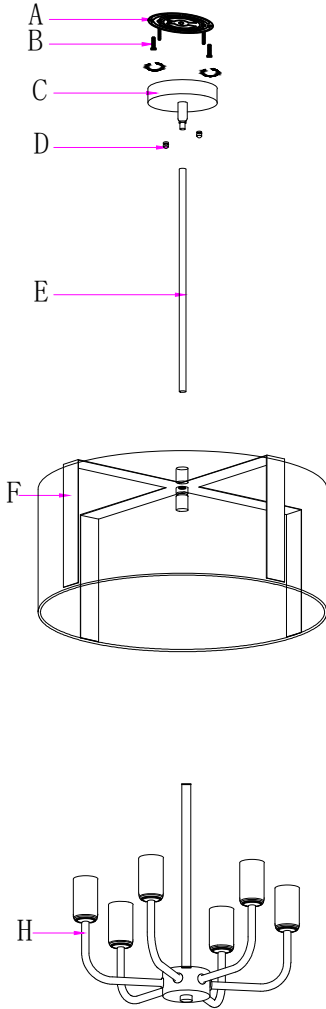

**2**

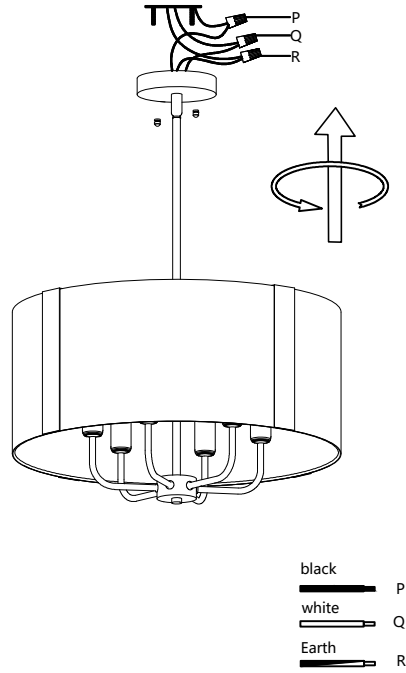

**Step 2:**  
 4. Connect the wires and your home wires to the connector (black to black, white to white, earth to earth)  
 5. Install the light fixture to the ceiling with M4 nut(D)

**3**

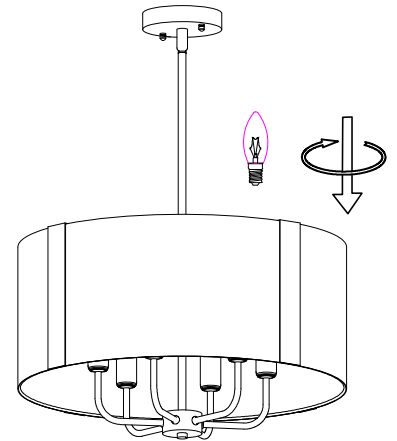

**Step 3:**  
 6. Finally, install the E12 light bulb to complete the installation.

**Step 1:**

1. Fix the Mounting Bracket(A) into the ceiling with Self-tapping screw(B)
2. Install Lamp Body(H) to the Fabric Lampshade(F)
3. Pass the wires through the Downrod(E) and Canopy(C)