

HELP CENTER

Question about your product? We're here to help. Visit us at:



Chat Support



Product Inquiry

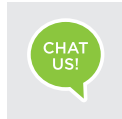

Orders FAQ



Product Assembly



Returns & Refunds

We Stand Behind the Quality of Their Furniture

If you have any issues with your item please let us know! We will always do our best to come up with a solution that you will be happy with.

Please get in touch with our customer service team before returning the product.

And pls do not throw the original box(es) if you have not finished assembling or confirmed no quality issues.

Length of return period:

Items can be returned within 30 days of purchase.

In the meanwhile, everything you purchased from us comes with a one-year warranty.

Who is responsible for the return shipping fee:

We will cover the return shipping fees if:

1. Your item has a manufacturing defect in its materials or workmanship. For example, torn wicker or misaligned screw holes. We will send you a prepaid shipping label after photos are sent.
2. Your item has been damaged in transit. For example, glass is broken or wicker is damaged. We will send you a prepaid shipping label after photos are sent.
3. You receive the wrong box(es) due to a warehouse error. We will send you a prepaid shipping label after photos are sent of the wrong SKU numbers on the outer box(es).
4. One or more boxes are lost in transit. We will send you a prepaid shipping label if you no longer want the item.

* However, we still hope to work with you for a better solution instead of a return. Please don't hesitate to contact our customer service team.

Customer will cover the return shipping fees if:

1. You don't like the product(s) after receiving the box(es).
2. You no longer need the product(s) but you have received the box(es).
3. You buy the product(s) by mistake but you have received the box(es).
4. Order/Shipment cancellation failed and you have received the box(es).

Return Request

In order to get a full refund as described in this return policy, all items must be: (1) In a brand new/unused condition, please provide photos before and after packaging. (2) When returning, all accessories and parts are firmly packed in all original packaging.

If your return does not meet the requirements, you may not get a full refund.

When will I be refunded?

The refund is released once the goods have been returned to our warehouse.

What if the product is damaged/defective outside of the valid return period?

We want you to be a happy customer. Please reach out to us by email and we will come up with a solution to make sure you are satisfied.

MANUAL INSTRUCTION

Rattan Wicker Couch

G13008BR-1

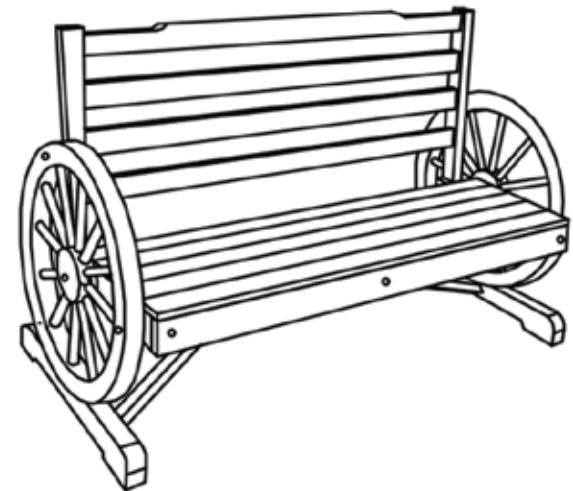

Rattan Wicker Couch G13008BR-1



We offer a diverse range of products to meet the needs of customers.

Outdoor Furniture

We are a professional furniture provider with top-notch factories and outstanding designs, Our mission is to provide consumers with new lifestyles. By collecting consumer feedback, we constantly improve our products and create more choices for consumers.

If you want to create your space, We are an ideal choice.

Always.



WARNING

Ensure that all parts
and hardware are
available before
beginning assembly

ALL WEATHER WICKER PATIO FURNITURE SWIVEL ROCKING CHAIR ASSEMBLY INSTRUCTION

⚠ WARNING

This chair is not a toy. Please don't over-swing the chair, because it could possibly make the chair tip over and results in injury. Proper use of the chair is for single person seating only. Moreover, the chair is not to be used for standing purposes and it will not function as a stool or step-ladder. In addition, please use this chair on even surfaces only. Chair tested for use at a weight of 250lb. Improper use of this product or failure to use as directed may result in injury. This chair is not intended for commercial use.

⚠ WARNING

1. Please keep all children and pets away from the assembly area. In addition, children and pets should be supervised when they are in the area of product construction.
2. Please make sure to keep the assembly area at least 6 feet from any obstruction such as a fence, garage, house, overhanging branches, laundry line or electrical wires.
3. Some parts may contain sharp edges. Therefore, when assembling and using this product, basic safety precautions should always be followed to reduce the risk of personal injury and damage to the product. Please read all instructions before assembly and use.
4. Please check all bolts for tightness before use. IMPORTANT-check and tighten bolts often to keep them secure!
5. The chair is not to be used for standing purposes and will not function as a stool or step-ladder. Again, this chair is used on even surfaces only.
6. The chair used at the weight of 250lb. Improper use of this product or failure to use as directed may result in injury. Not intended for commercial use.

CARE&MAINTENANCE

STAIN RESISTANT CUSHIONS CARE-KEEP THE CUSHIONS IN STORAGE IN RAINING DAY.

SPILLS

Please immediately wipe up the spill using a white damp cloth. Repeat process if necessary until stain is gone. Allow the cushion to air dry.

FABRIC CARE



Please use cold water and hand wash, use non-chlorine bleach when needed, lay flat to dry. Cool iron if necessary. Do not dry clean.

RESIN WICKER PRODUCT CARE

Before using, please clean the product completely with a soft dry towel. Moreover, when the chair not in use, you should wipe off any dirt or loose objects, wash with a mild solution of soap and water, rinse thoroughly and dry completely. Please do not use strong detergent or abrasive cleaners. Since nuts and bolts can loosen over time, so please check nuts and bolts on all chairs and tables, re-tighten if necessary.

PRODUCT ASSEMBLY

3 Step 3

PART	NO.	QTY.
	④	2
	H	4

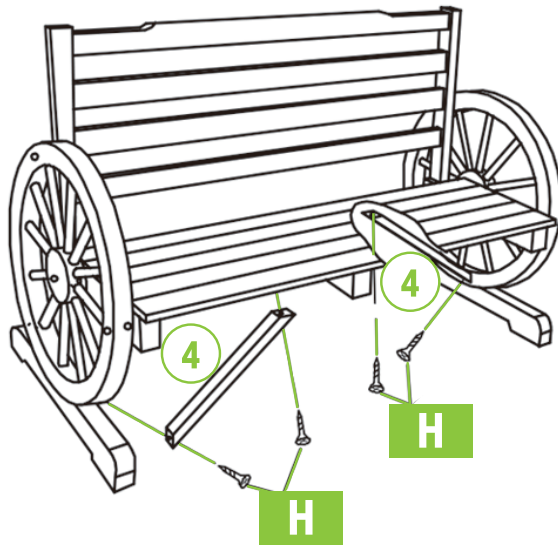

4 Step 4

PART	NO.	QTY.
	⑤	1
	H	5

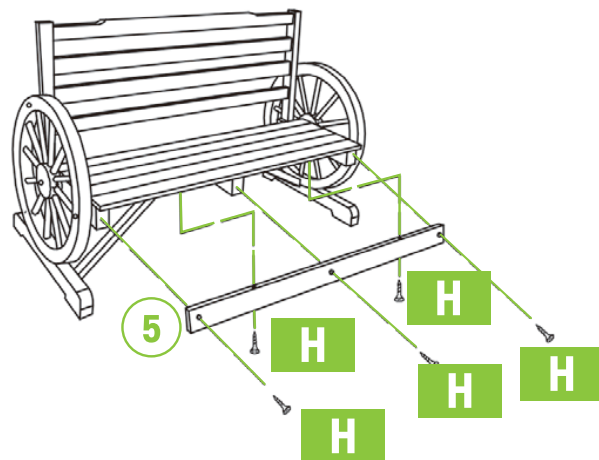

IMPORTANT

Please read all the instructions and warnings before assembling. In order to make the whole product adjust to the best, please install all the screws on the product and tighten all the screws after adjusting the product which can stand on the floor even.

TOOLS REQUIRED



Phillips Screwdriver

 1 Persons Assembly

 Up to 30 Minutes For Assembly

PARTS

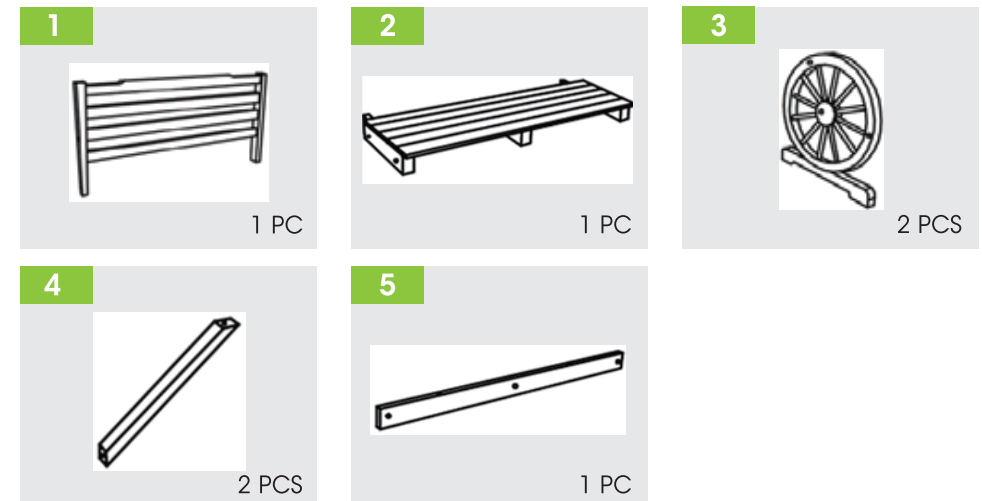

HARDWARE

G M8 X 60MM



2 SETS

F M8 X 75MM



2 SETS

E M8 X 100MM



4 SETS

H M3.5 X 40MM

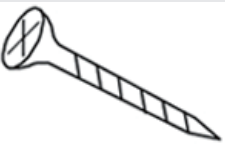

9 PCS

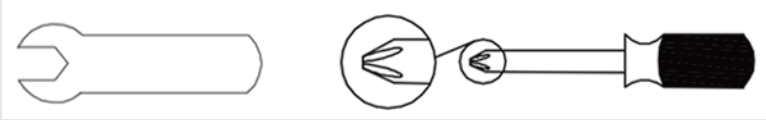

TOOK



1 PC



PRODUCT ASSEMBLY

Step 1 F35-C25

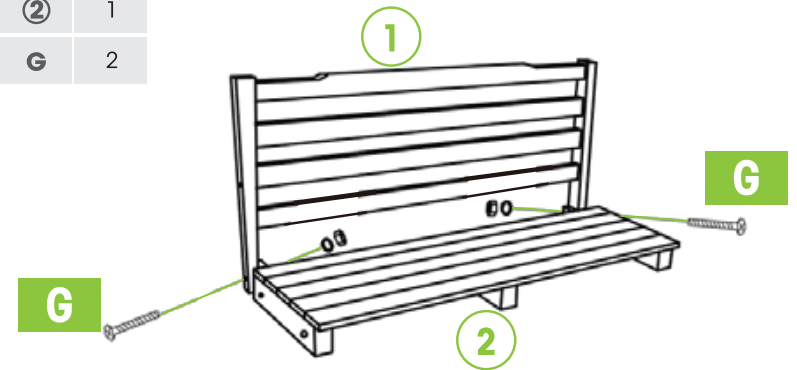
PART	NO.	QTY.
	①	1
	②	1
	G	2



2 Step 2

PART	NO.	QTY.
	③	2
	F	2
	E	4

