

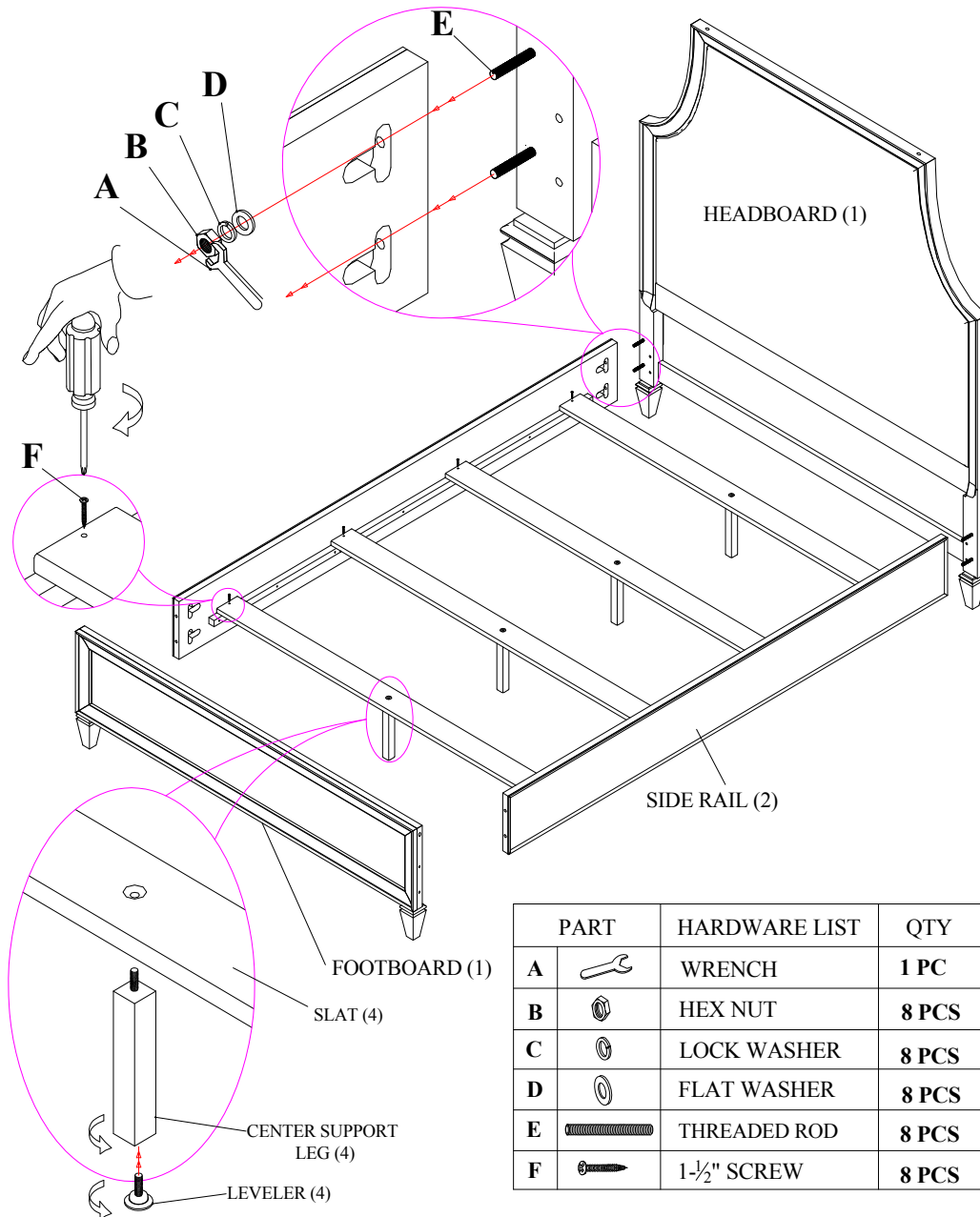





LEXINGTON®

HOME BRANDS

ASSEMBLY INSTRUCTIONS

415-133C/134C/135C Inverness Upholstered Panel Bed



PART	HARDWARE LIST	QTY
A	 WRENCH	1 PC
B	 HEX NUT	8 PCS
C	 LOCK WASHER	8 PCS
D	 FLAT WASHER	8 PCS
E	 THREADED ROD	8 PCS
F	 1-1/2" SCREW	8 PCS

For additional consumer assistance please contact your Lexington dealer or call our Consumer Services Department at 1-336-474-5300, Monday-Friday, 8-5 Eastern.

LEXINGTON®

H O M E B R A N D S

ASSEMBLY INSTRUCTIONS

415-133C/134C/135C Inverness Upholstered Panel Bed

How to Attach Side Rails to Headboard/Footboard

* All needed hardware is located in a hardware bag which should be taped to inside of side rail.

1. Insert threaded rod (E) into metal dowel in post thru open hole. Twist clockwise until tight.
2. With both threaded rods in place, and side rail positioned with T-slots to inside, slide side rail over threaded rods.
3. Add flat washer (D) and lock washer (C) to threaded rod.
4. Add hex nut (B) with barrel end towards washer.
5. Tighten nut with wrench (A) until tight. Repeat process for other three corners.

How to Attach Slats to Side Rails

1. Insert bolted end of adjustable leveler into bottom of center support leg and twist until tight. Insert bolted end of support leg into bottom of slats. There is a T-nut in the center of the board. Rotate clockwise until tight.
2. Adjust leveler so that support leg and leveler sit ½" above floor.
3. Place a slat 3" to 5" inward from each end of wood cleats. Place two slats between two end slats so that there is an equal amount of space between all four slats.
4. Secure slats with wood screws (F) provided. Note that top side of slat has larger hole.