

Top View

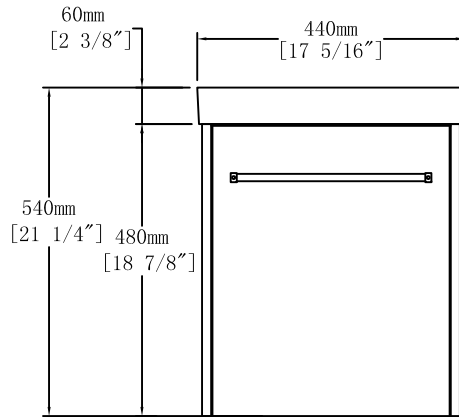

Front View

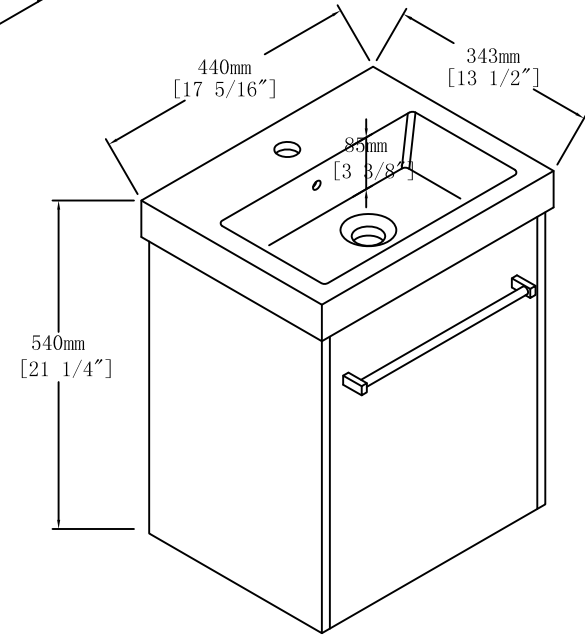
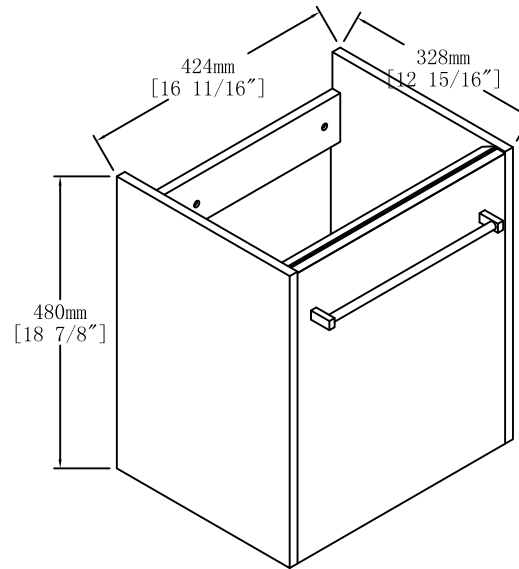
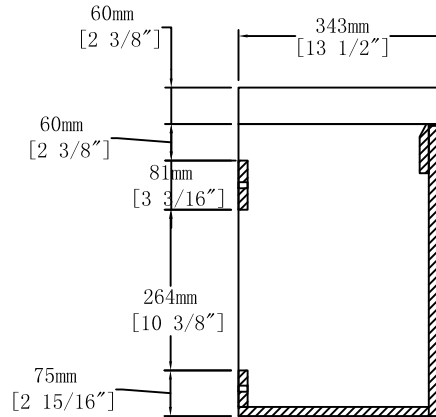

Side View



Item NO.

BV C10918

Version

V1

Project

Date

2024-9-25