

# Assembly Instruction









## Sofa



Legs and hardware are stored on the seat, please take them out for assembly.

Note: Do not use power tools for assembly. Power tools increase the risk of over tightening which lead to splitting or cracking the wood.

### Component list

| No | Drawing   | Qty | Description                   |
|----|---|-----|-------------------------------|
| A  |    | 1   | SEAT BASE                     |
| B  |   | 1   | BACKREST                      |
| C  |  | 3   | BACK CUSHIONS                 |
| D  |  | 3   | SEAT CUSHIONS                 |
| E  |  | 4   | PILLOWS<br>(19*19")           |
| F  |  | 4   | WOODEN LEGS<br>(177*177*45mm) |
| G  |  | 1   | CENTER LEG<br>(60*40mm)       |
| H  |  | 8   | BOLTS<br>1/4*-20*45MM         |
| I  |  | 1   | ALLEN KEY<br>5/ 32mm          |

# Step 1

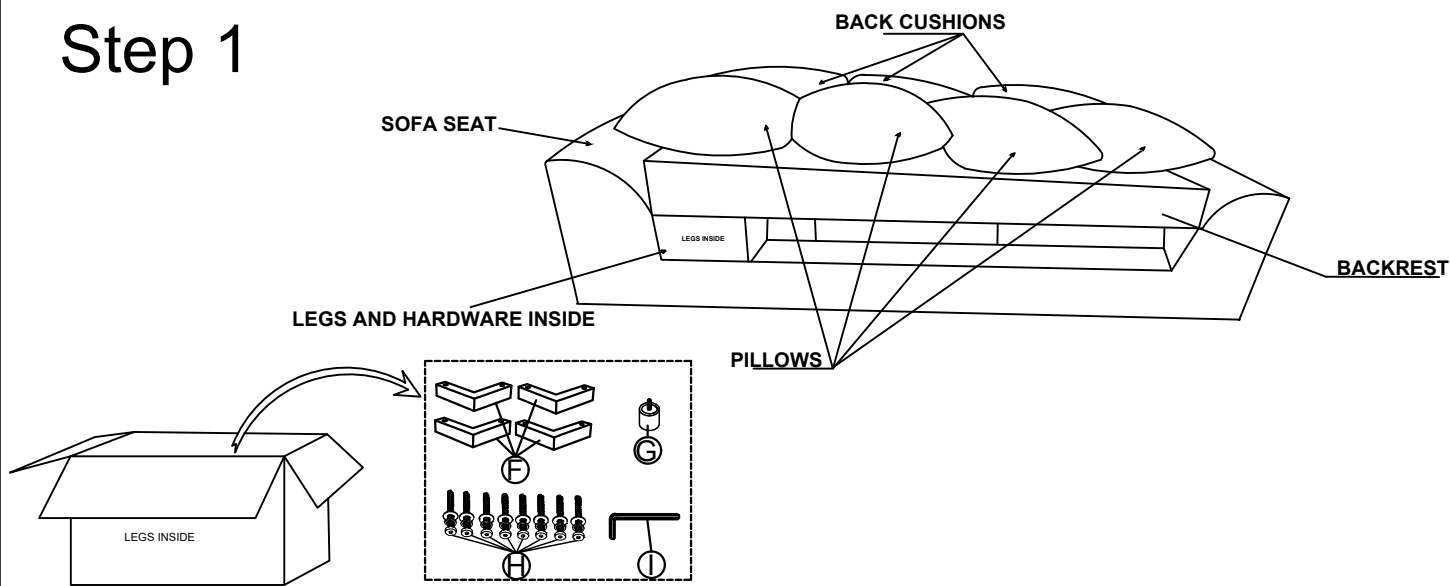

# Step 2

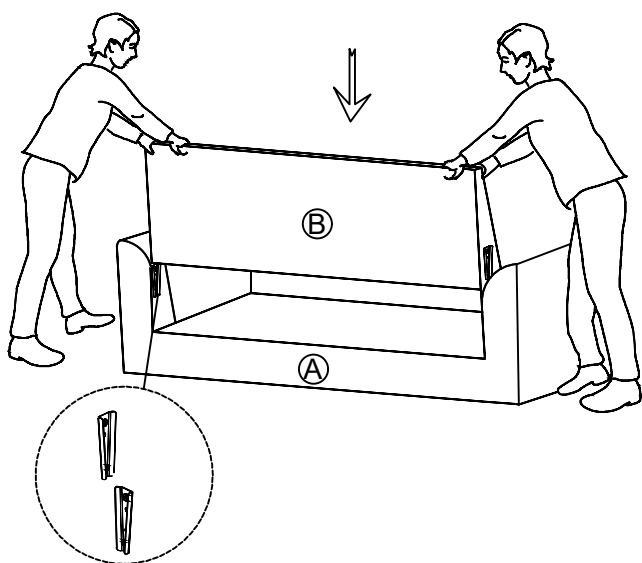

# Step 3

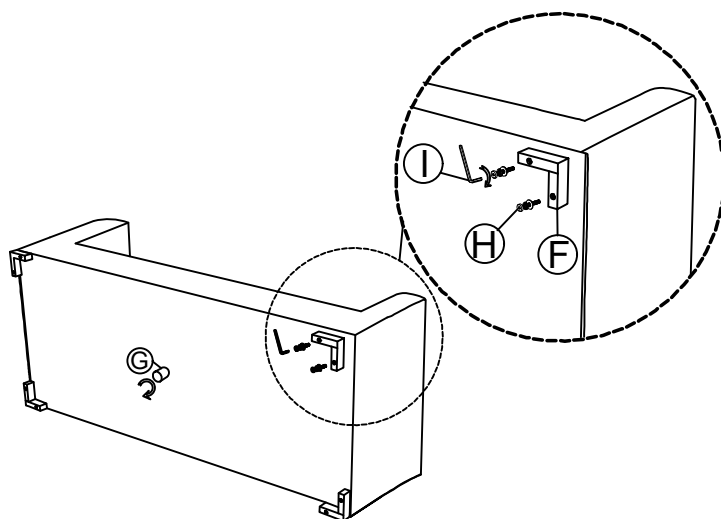

# Step 4

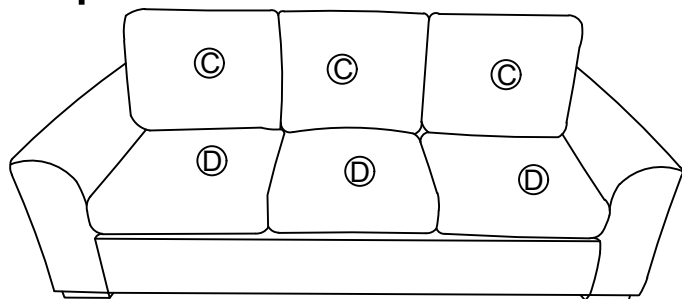

# Completed

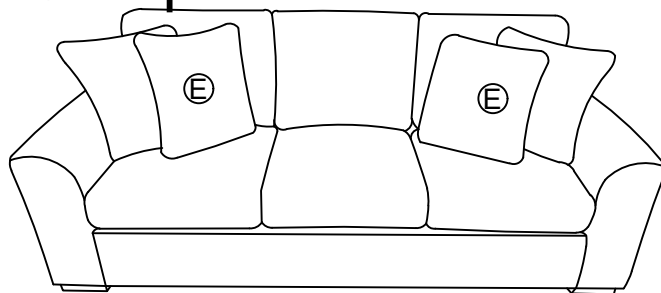

## Care Instruction for Textured Fabric Furniture:

In order to maintain the original appearance of your textured fabric furniture, please follow below simple care procedures:

- Avoid exposing furniture directly to sunlight or heating and air conditioning outlets. Sunlight and/or exposure to heating and air conditioning outlets will fade/damage fabrics. Do not place your upholstered furniture too close to windows, radiators, or vents, and be sure to use windows, radiators, or vents.
- Vacuum or wipe with a soft cloth to remove dust.
- Hardware may loosen over time. Periodically check to make sure all connections are tight. Re-tighten if necessary



For items use on wooden floor, hard surfaces or carpets, it is recommended to install protective pads under all legs and supports to avoid/prevent from damages/scratches and discoloration.