

ASSEMBLY INSTRUCTIONS

IMPORTANT NOTE

- ** Place all parts on a lean and smooth surface such as a rug or carpet to avoid the parts from being scratched.
- ** Before you begin, please review the assembly instruction step by step.
- ** Return & Warranty policy:
 - We strive to offer the highest quality products. We also provide positive solutions with replacements or refund if needed.
 - If the item is damaged or defective, please take photos to show the problem and email to the seller.
 - Please do not return back the products before contact the seller.

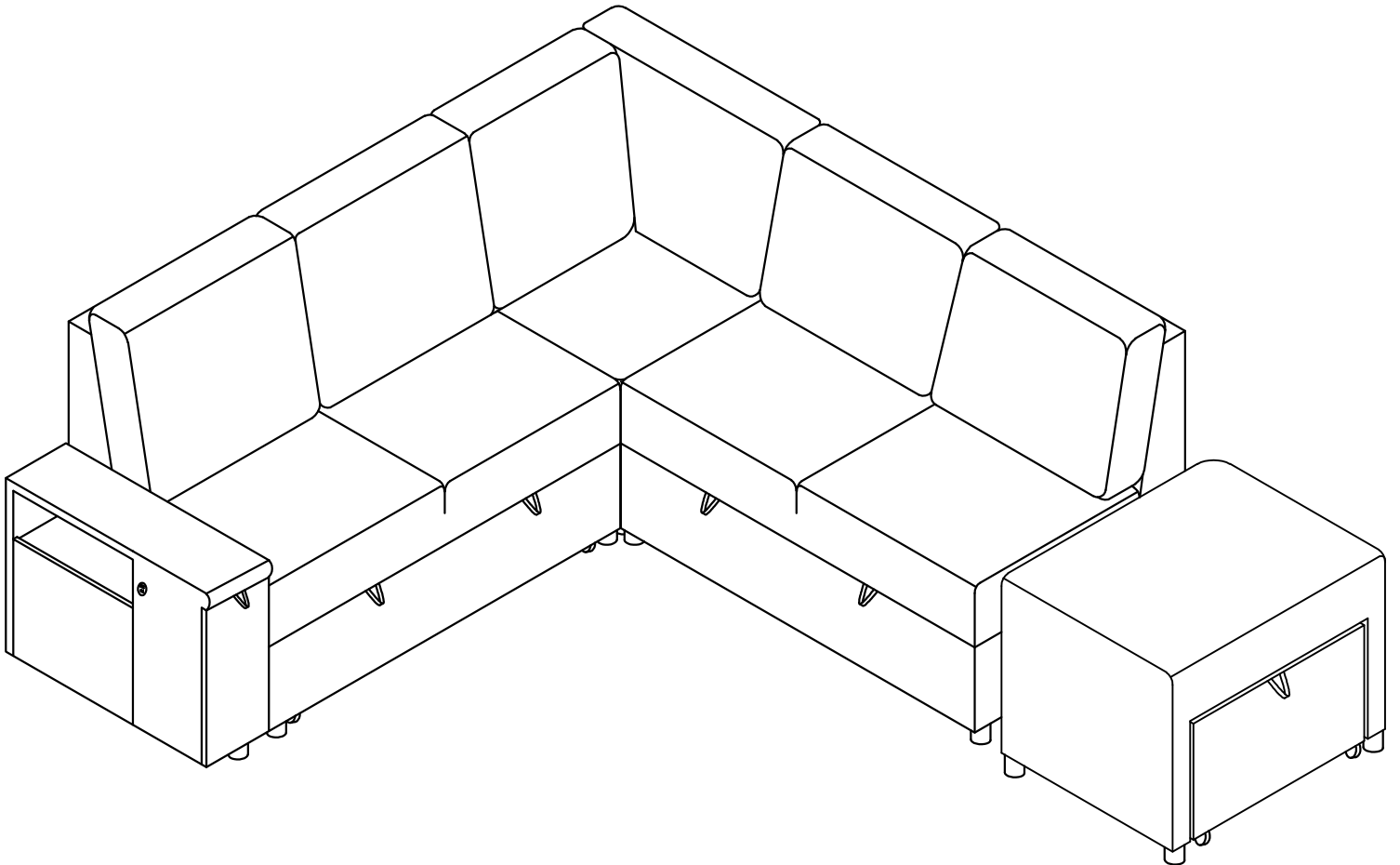

ASSEMBLY INSTRUCTIONS

PART LISTS BOX 1:

A

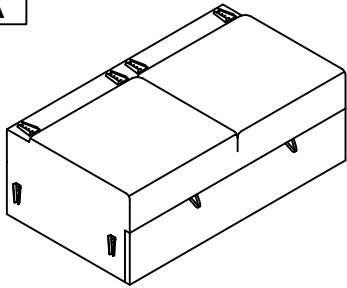

LOVESEAT (1 PC)

O



LOVE SEAT CUSHION
BACK (2 PCS)

K

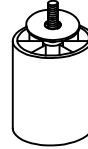

LEG (18 PCS)

L



WHEEL (8 PCS)

PART LISTS BOX 2:

B

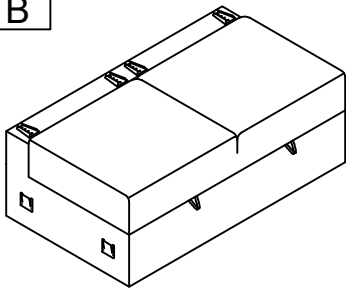

CHAISE (1 PC)

H

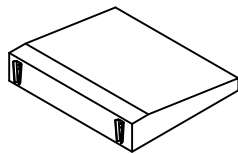

LOVE & CHAISE BACK
(4PCS)

J



CORNER CUSHION
BACK (1PC)

M



SCREW M4*30
(32 PCS)

PART LISTS BOX 3:

D

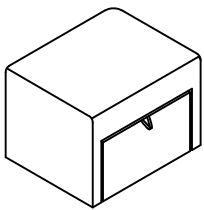

OTTOMAN (1 PC)

O

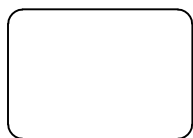

CHAISE SEAT
CUSHION BACK
(1PC)

PART LISTS BOX 4:

C

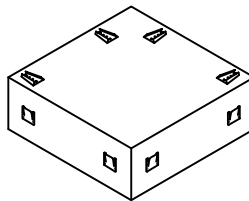

CORNER (1 PC)

I



CORNER CUSHION
BACK (1PC)

O



CHAISE SEAT
CUSHION BACK
(1PC)

PART LISTS BOX 5:

E

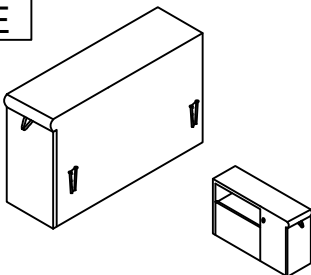

ARM (1 PC)

F

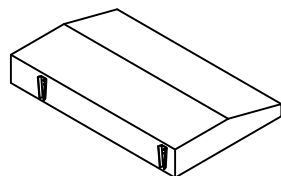

CORNER
BACK (1PC)

G

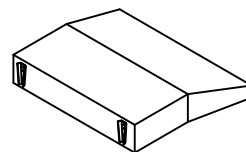

CORNER CHAIR
CUSHION BACK (1PC)

N

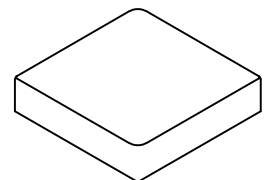

CORNER SEAT
CUSHION (1PC)

Step 1

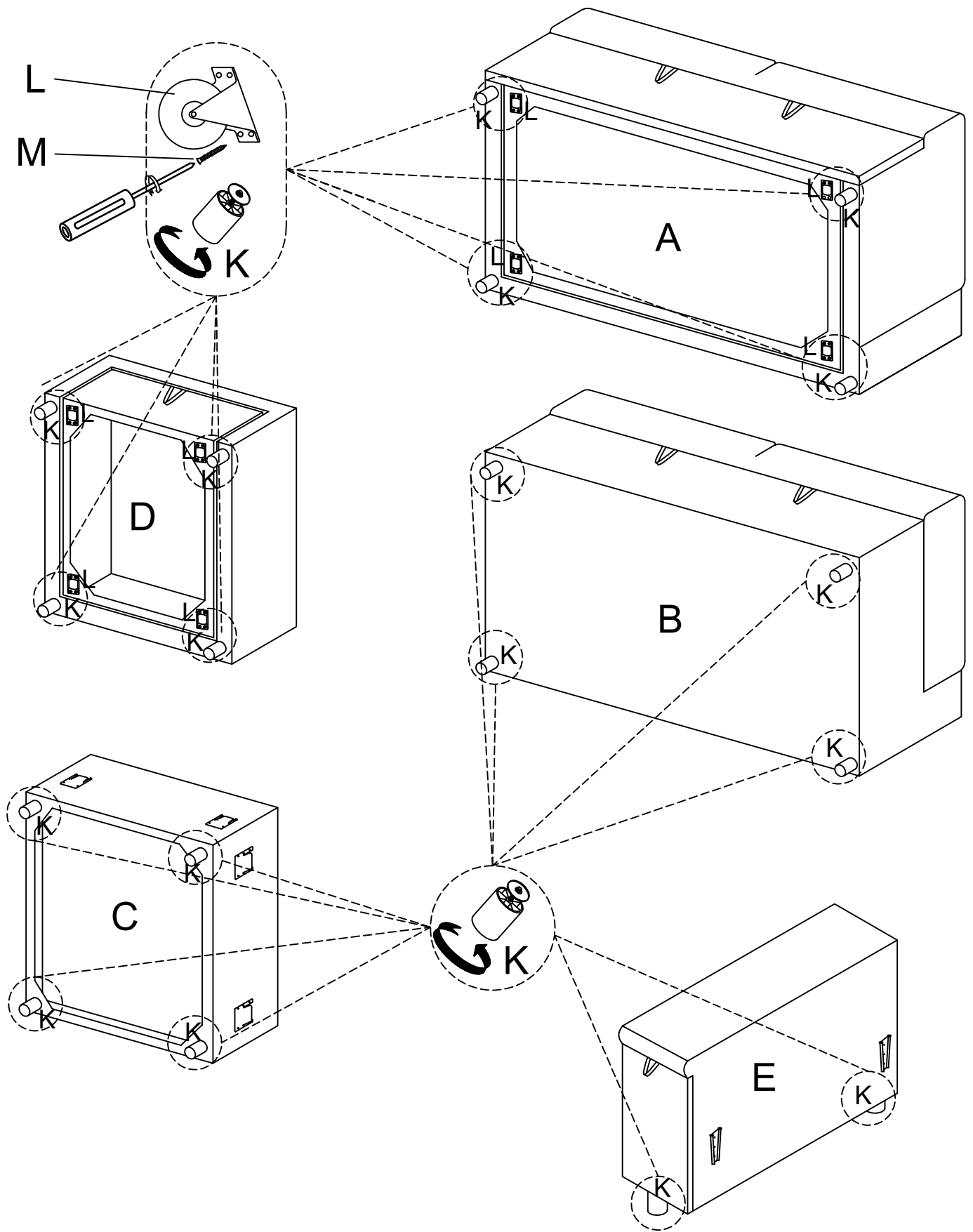

Step 2

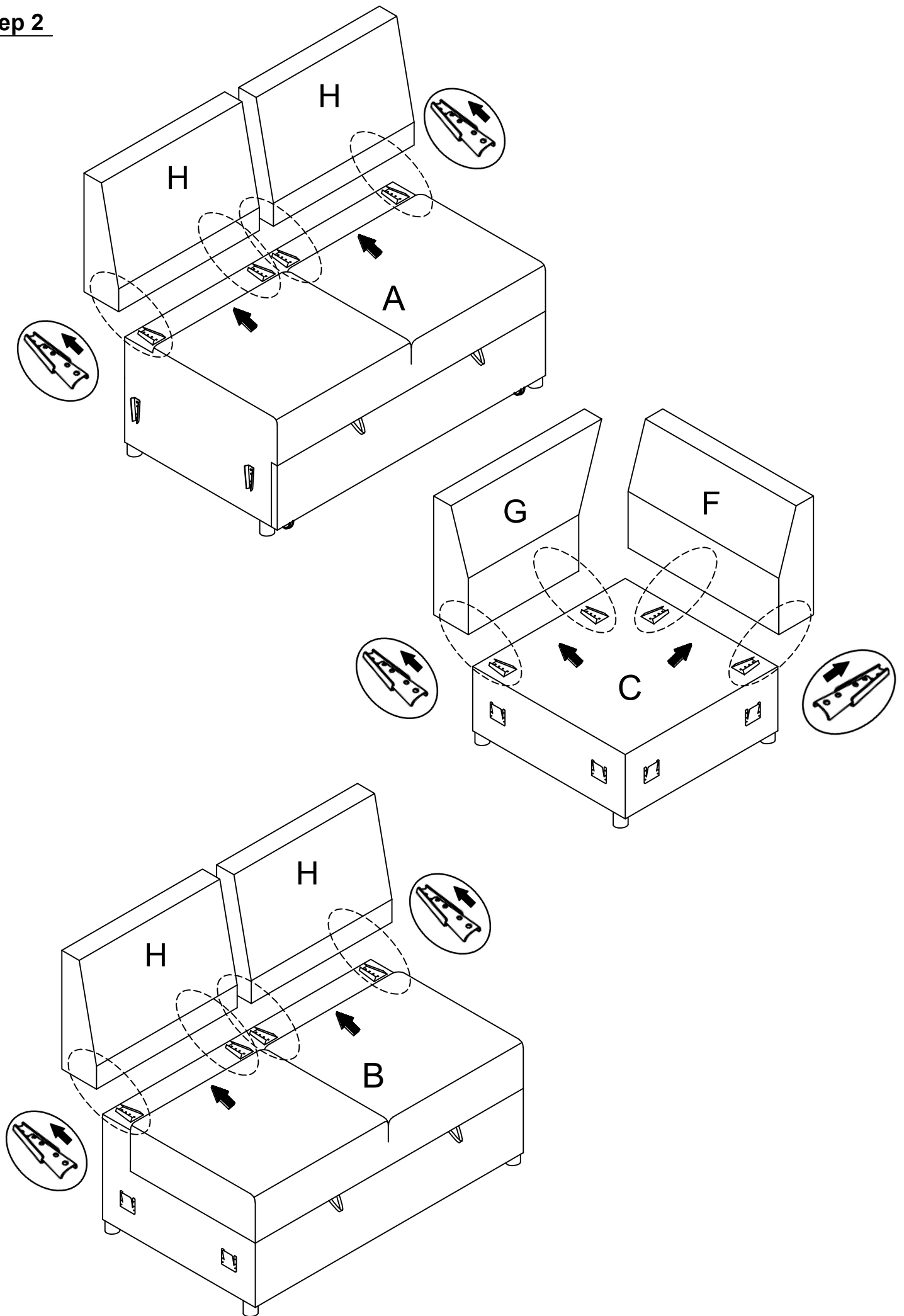

Step 3

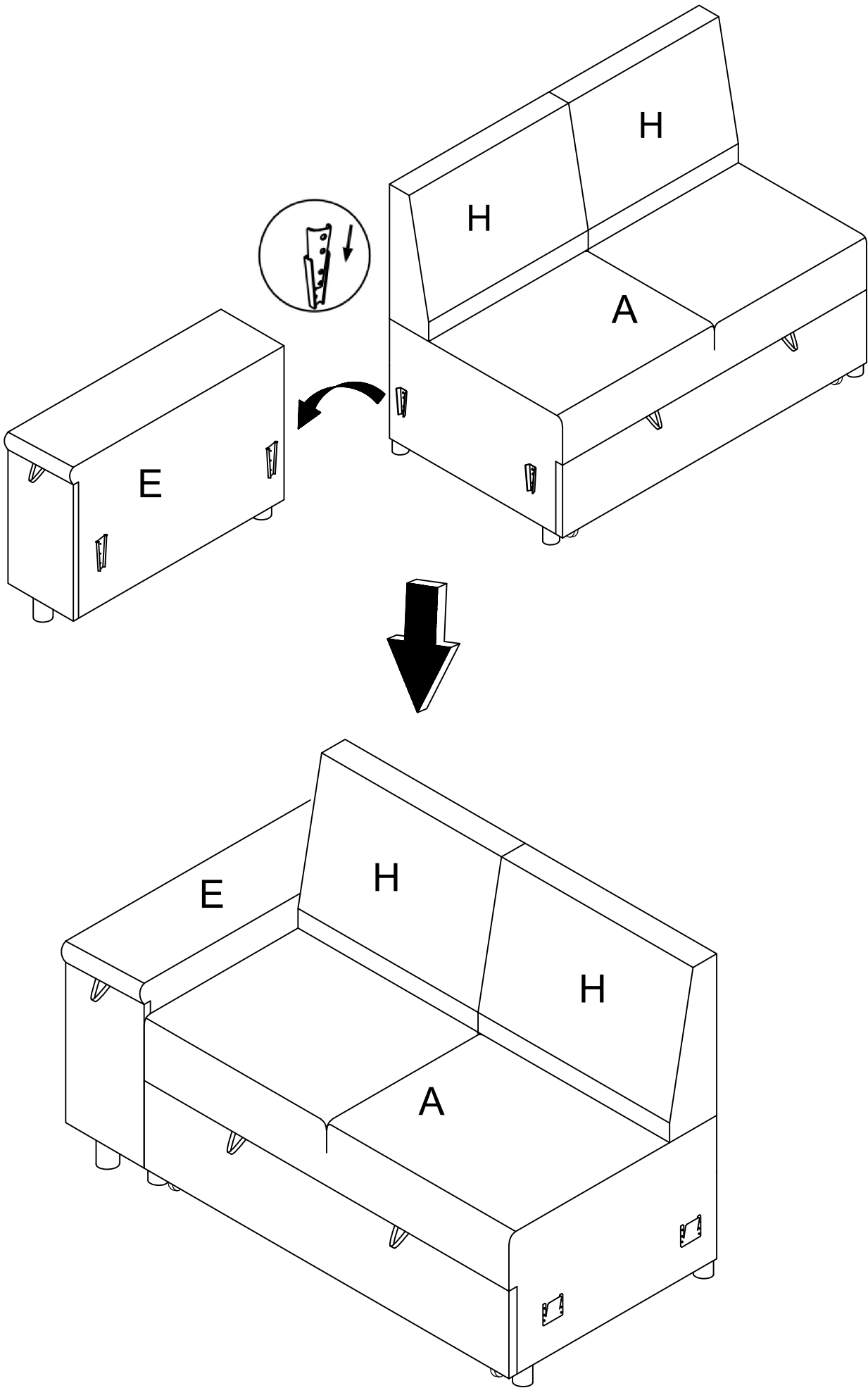

Step 4

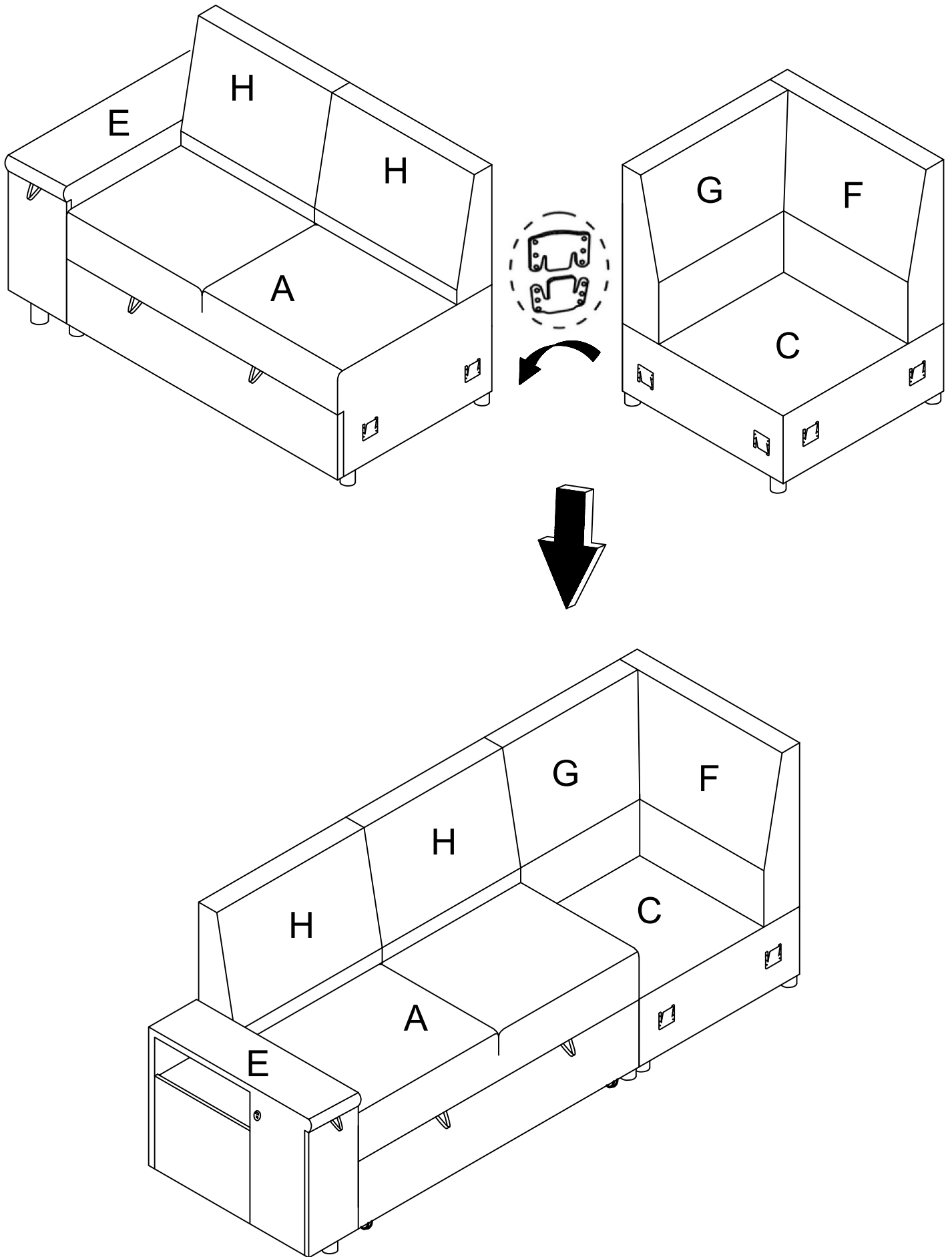

Step 5

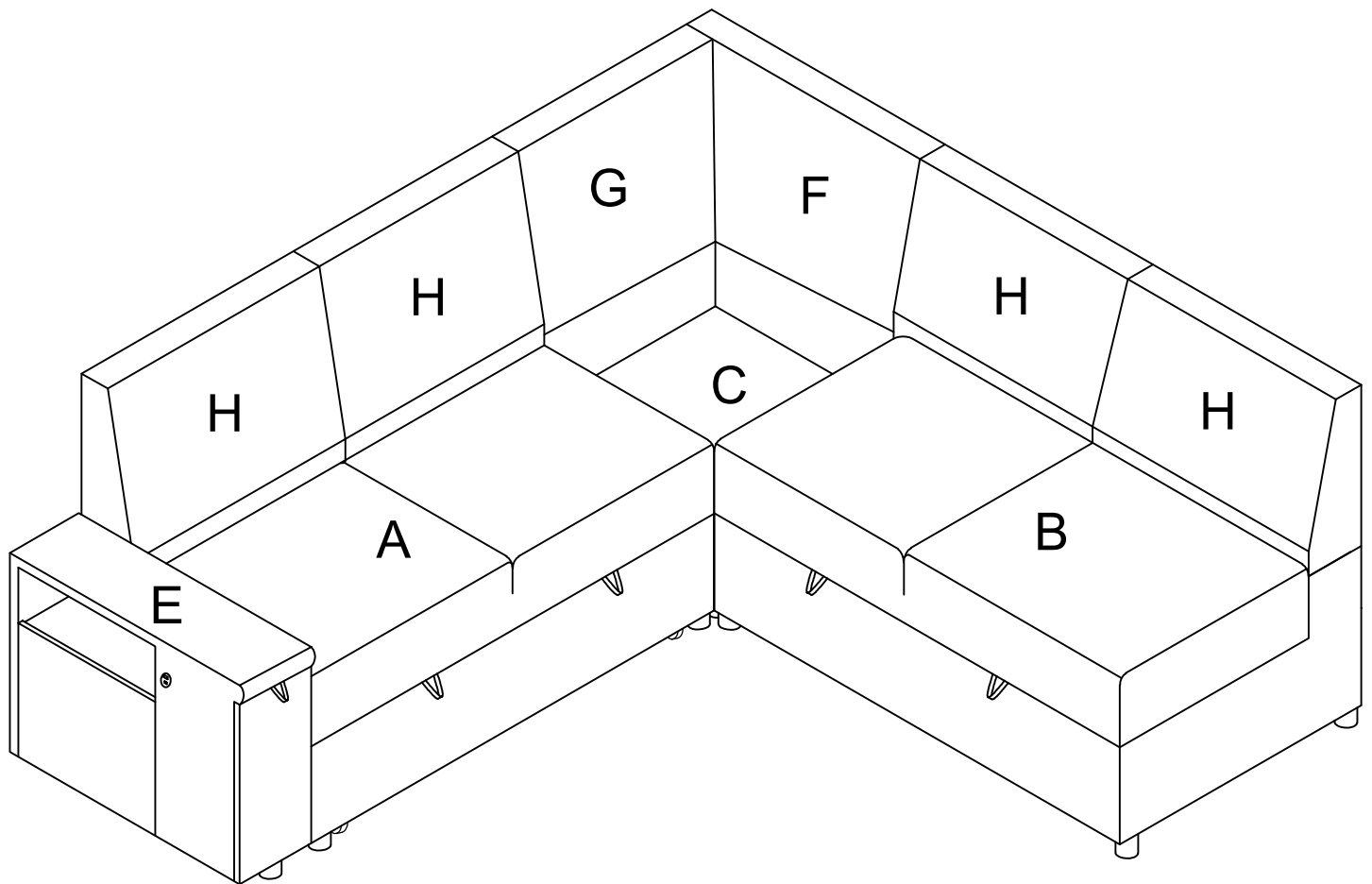
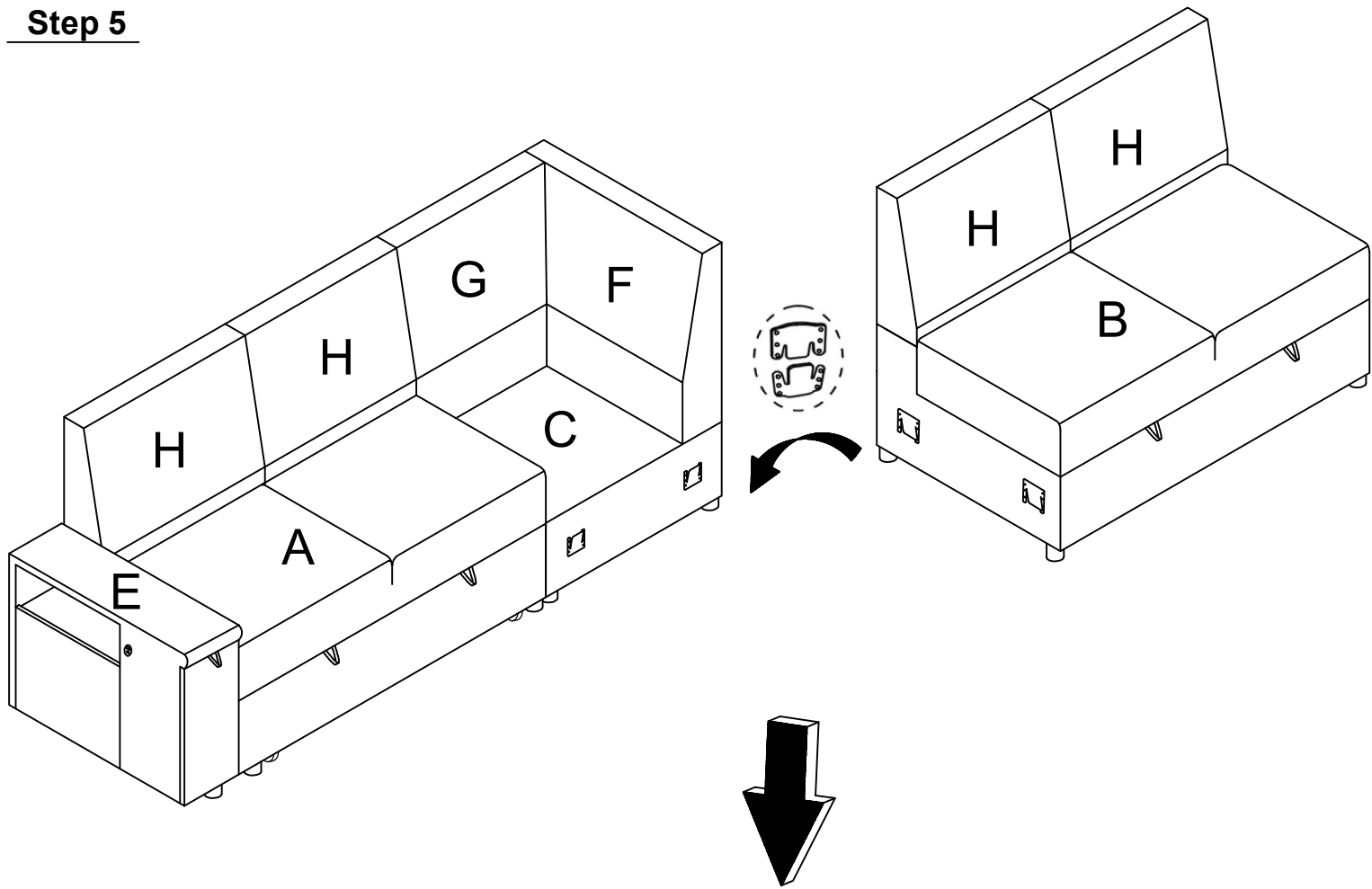

Step 6

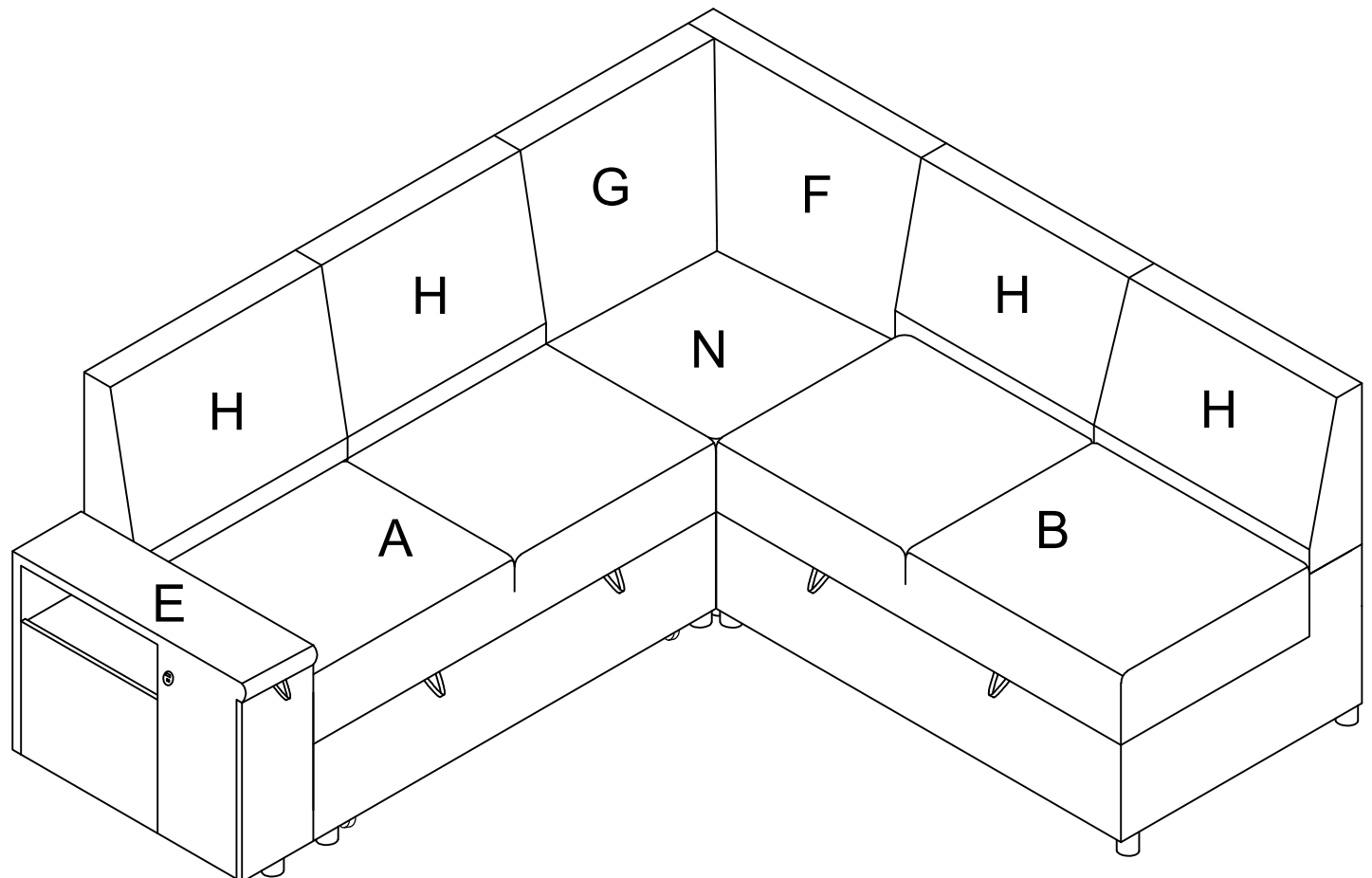
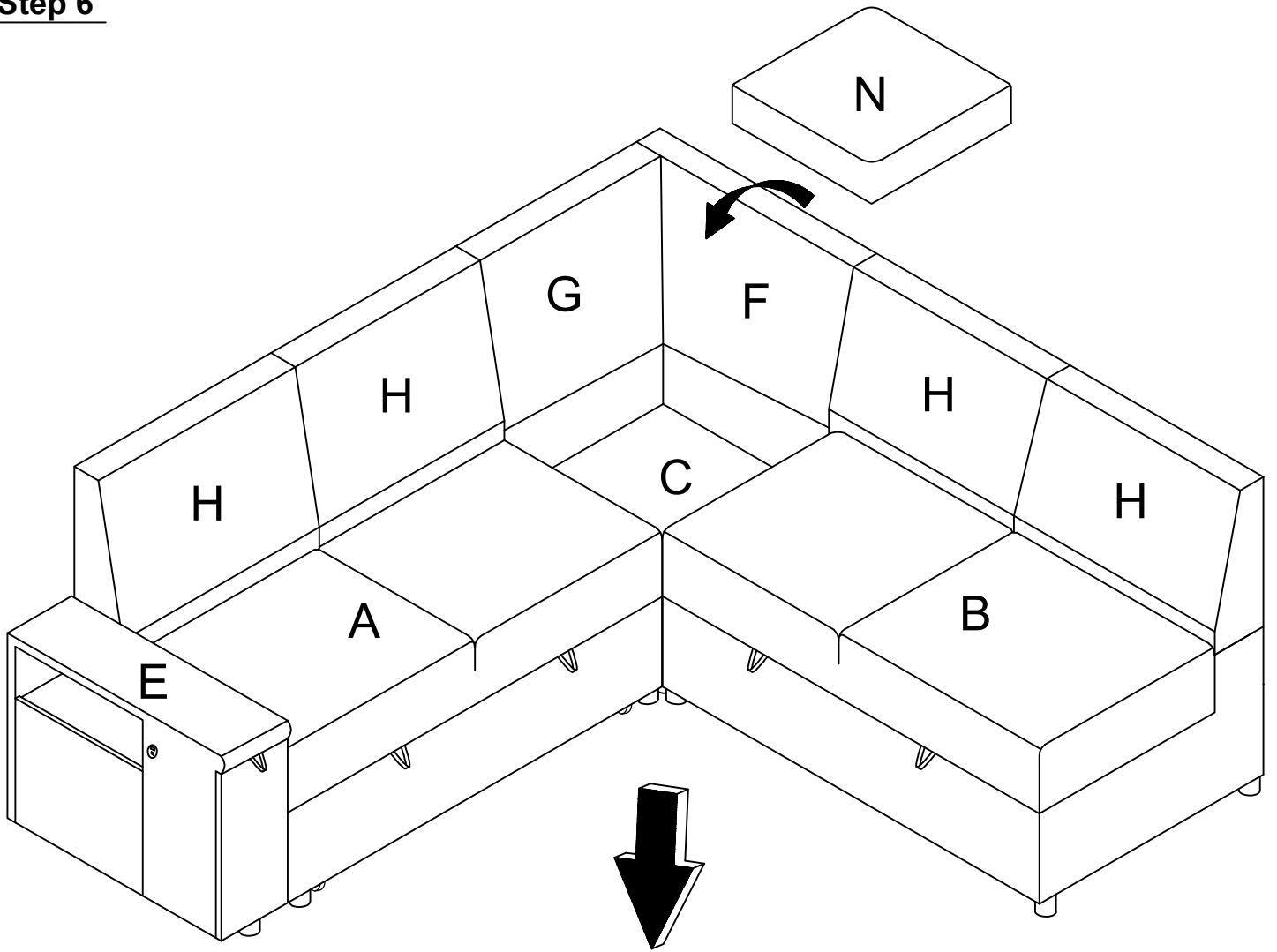

Step 7

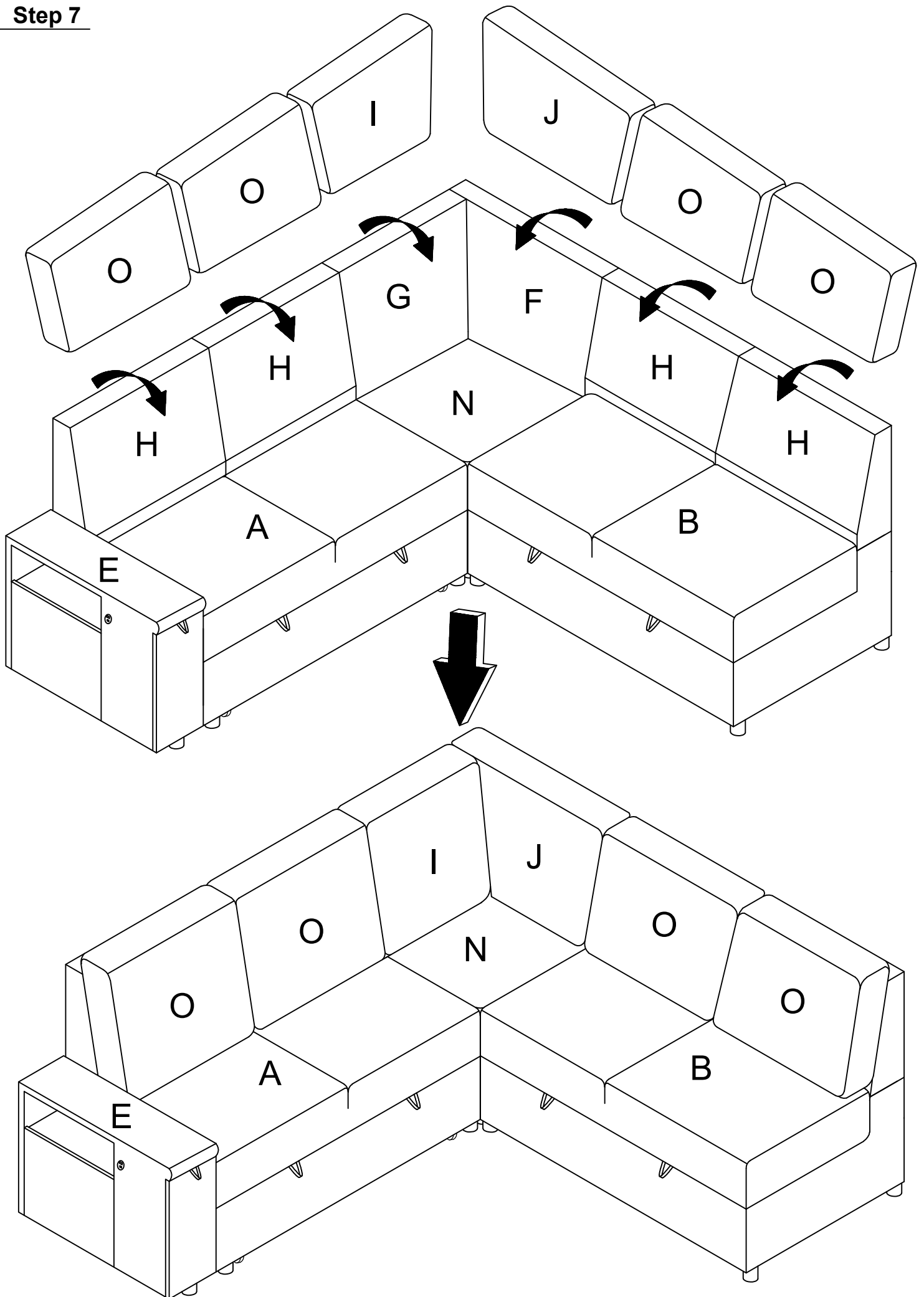

Step 8

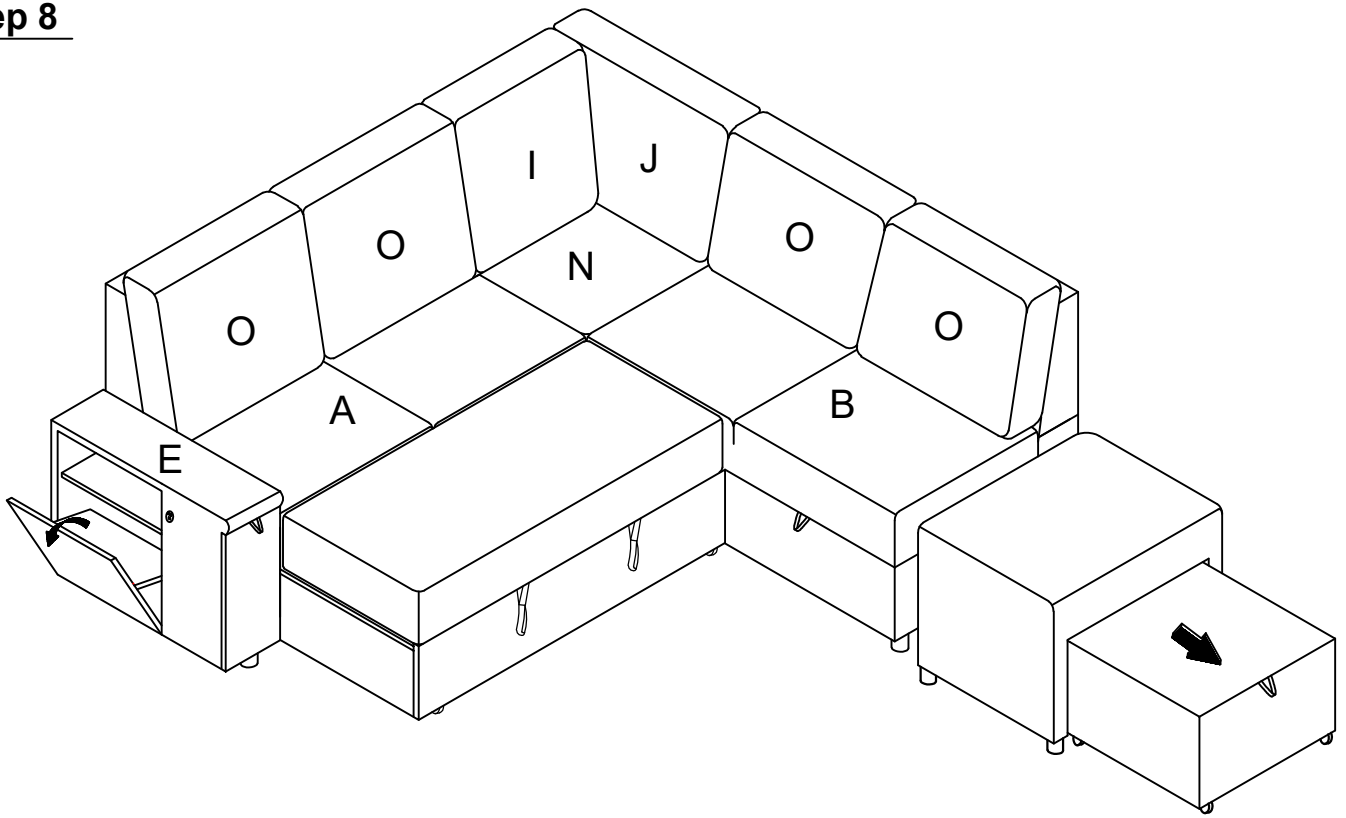

Step 9

