

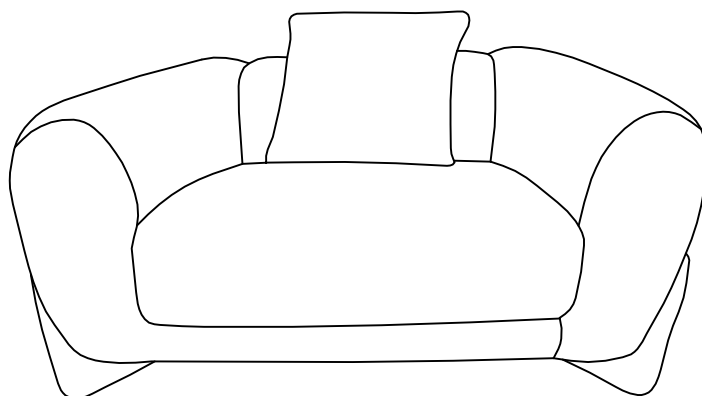

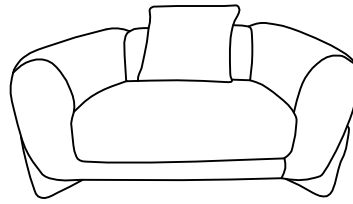

CLOUD SOFA





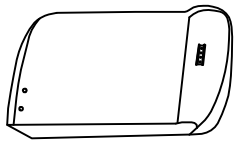
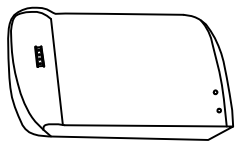

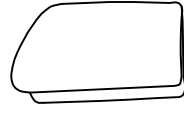
# ASSEMBLY INSTRUCTIONS



# ASSEMBLY INSTRUCTIONS



A	 LEFT ARM	1 PC
B	 RIGHT ARM	1 PC
C	 PILLOW	1 PC
D	 BACK FRAME	1 PC
E	 SEATER	1 PC
F	 LEG	4 PCS

1	 Ø <sup>5</sup> / <sub>16</sub> "**60mm	9 PCS
2	 ALLEN KEY	1 PC
3	 Ø <sup>5</sup> / <sub>16</sub> "**17mm	13 PCS
4	 Ø <sup>5</sup> / <sub>16</sub> "**90mm	4 PCS
5	 Ø <sup>5</sup> / <sub>16</sub> " NUT	5 PCS
6	 Ø <sup>5</sup> / <sub>16</sub> "	5 PCS
8	 ALLEN KEY	1 PC

## Step 1

Remove the pillows from the bottom of the armrests before assembly.

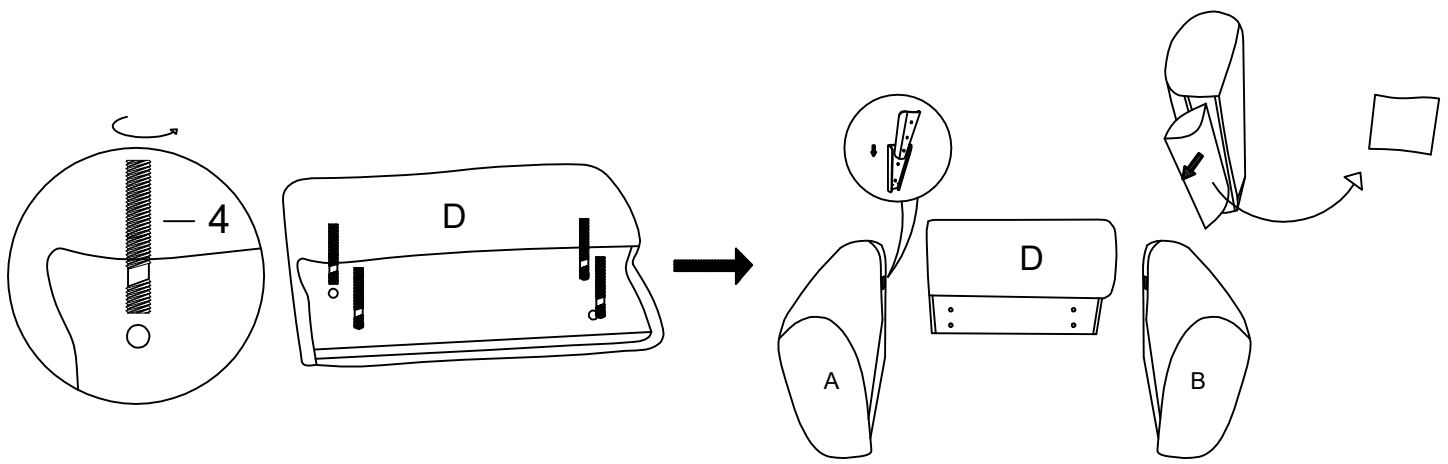

## Step 2

Assemble the bench on a soft, scratch-free surface (e.g., a carpet), then tighten the seat back screws with an allen key after the assembly is complete.

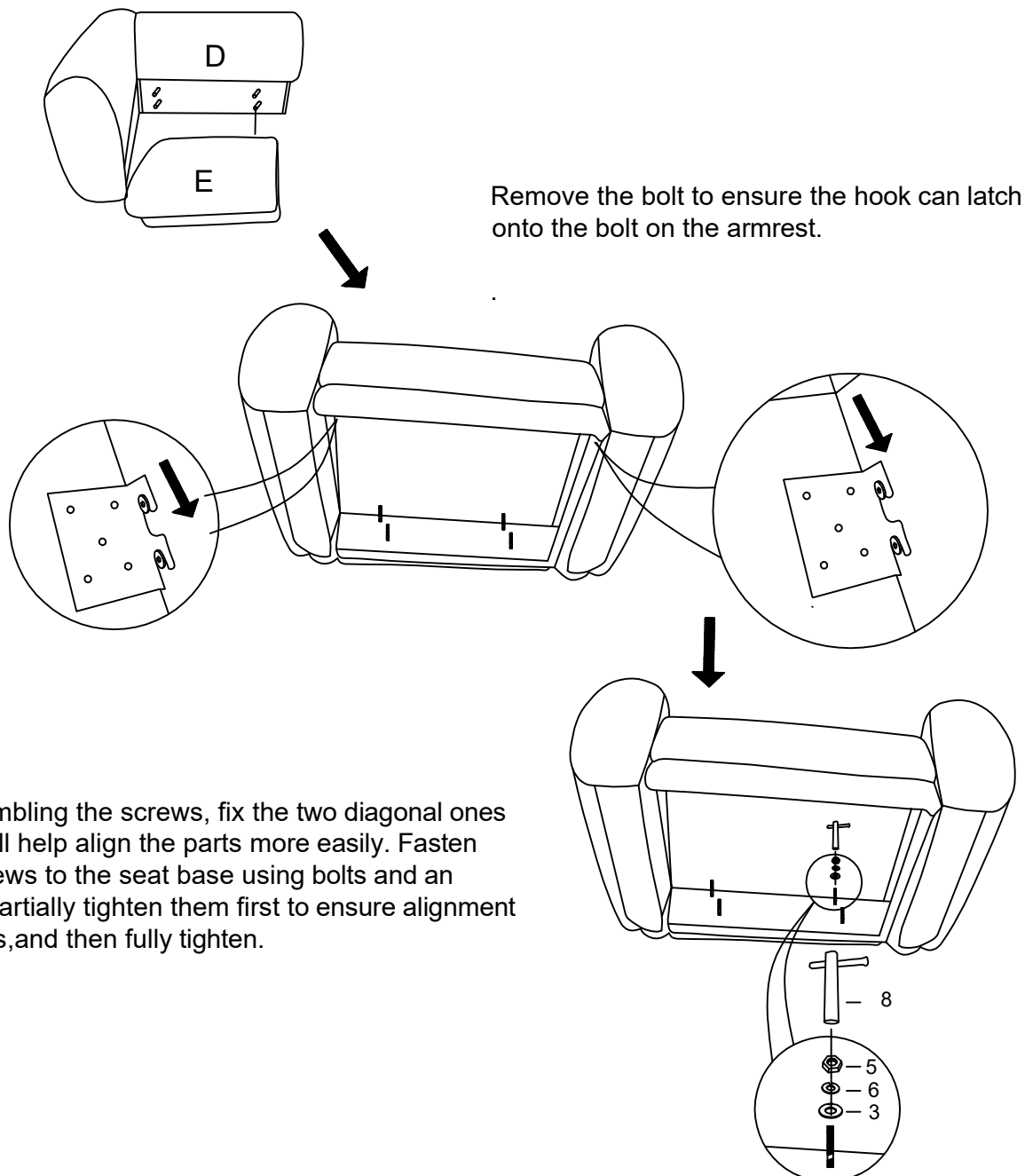

When assembling the screws, fix the two diagonal ones first. This will help align the parts more easily. Fasten the four screws to the seat base using bolts and an Allen key. Partially tighten them first to ensure alignment with the nuts, and then fully tighten.

## Step 4

Insert the bracket halfway and leave some space. After locating the screw positions, secure the bracket and fully tighten all bolts.

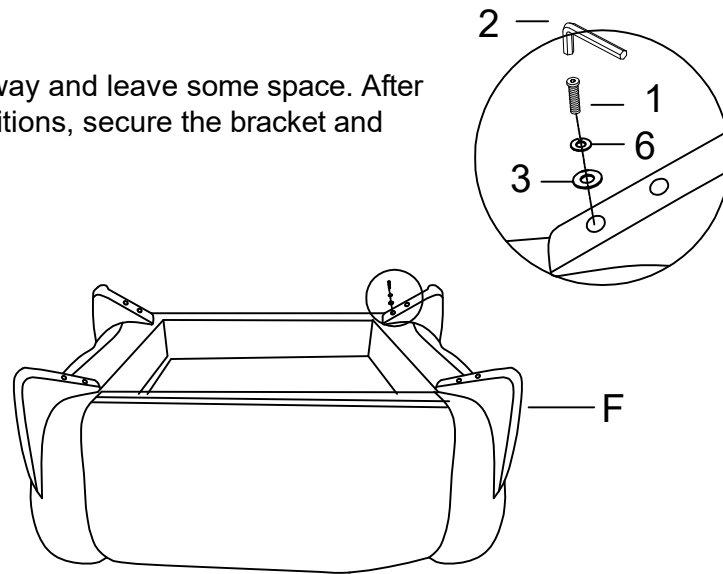

## Step 5

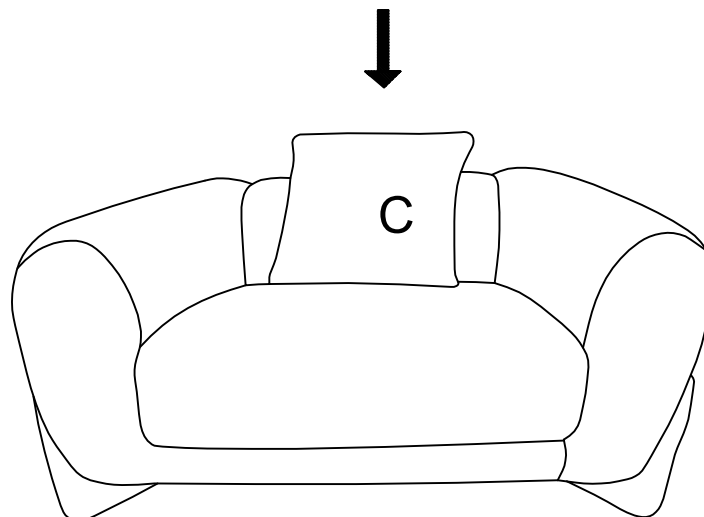

# ITEM: CLOUD CHAIR

## ASSEMBLY INSTRUCTIONS

### ASSEMBLY TIPS

1. Remove hardware from box and sort by size.
2. Please check to see that all hardware and parts present prior to start of assembly.
3. Please follow attached instruction in the same sequence as numbered to assure fast & easy assembly.

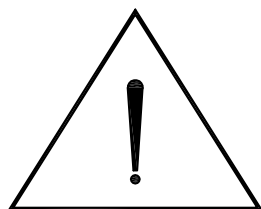

## **WARNING !**

1. Don't attempt to repair or modify parts that are broken or defective. Please contact the store immediately.
2. This product is for home use only and not intended for commercial establishments.

**ASSEMBLY TIME :15-30 MINUTES**

