

Caution: You must read this before you proceed

Assembly Instructions

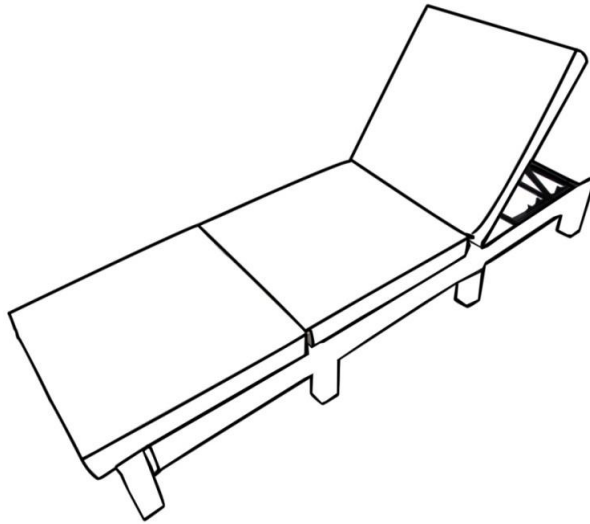

Chaise Lounge





**CAUTION : This Lounge is NOT a TOY.
Keep your child / children at bay during the assembly process.**

Parts List

Label	Picture	Description	QTY
A	A line drawing of a rectangular seat panel, showing four screws along its edges.	Seat Panel	1
B	A line drawing of a rectangular cushion, showing its shape and depth.	Cushion	1

C		Front & Back Leg	4
D		Middle Leg	4





Hardware

Label	Picture	Description	QTY
E		Allen Key	1
F		Boit(M6*25MM)	17

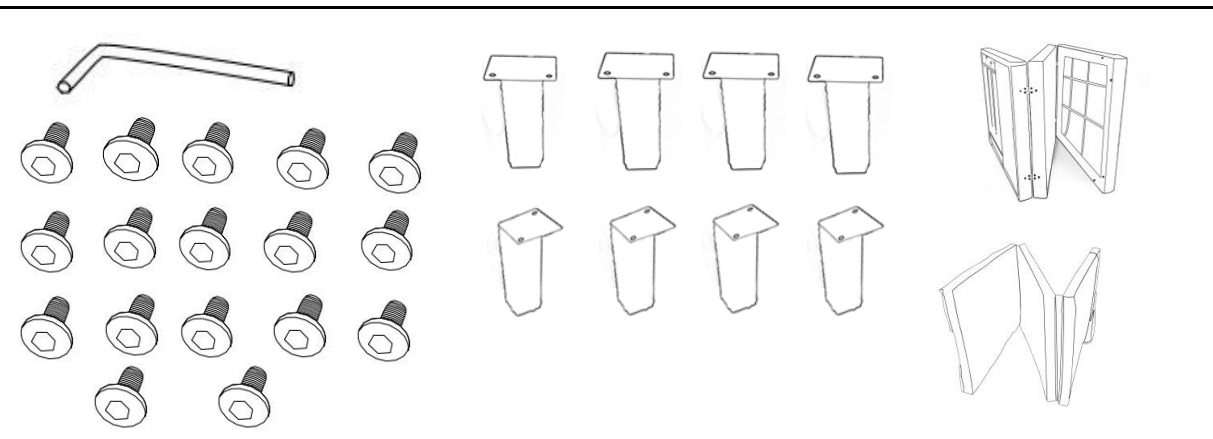
Assembly Preparation

Before Beginning Assembly:



-  • Read instructions, cover to cover-
-  • Have 2 adults on hand for assembly-
-  • Do not assemble on flooring or carpet-
-  • Assemble on a clean non-marring surface (packing foam)-
-  • Save all packaging until finished-

Assembly Steps

Step 1

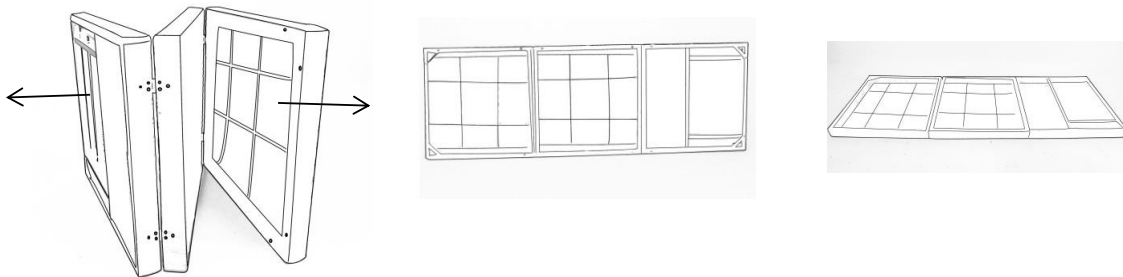

Unpack all parts and place on a clean, non-marring surface.
Unfold Seat Panel(A) in both left and right directions .
Then put it facedown on the floor.

Caution: The Lounge Parts are large and heavy, always have a second Adult to assist you whenever lifting or moving them. At the same time, please don't put your hand in the middle of the gap to avoid any hurt.

Step 2

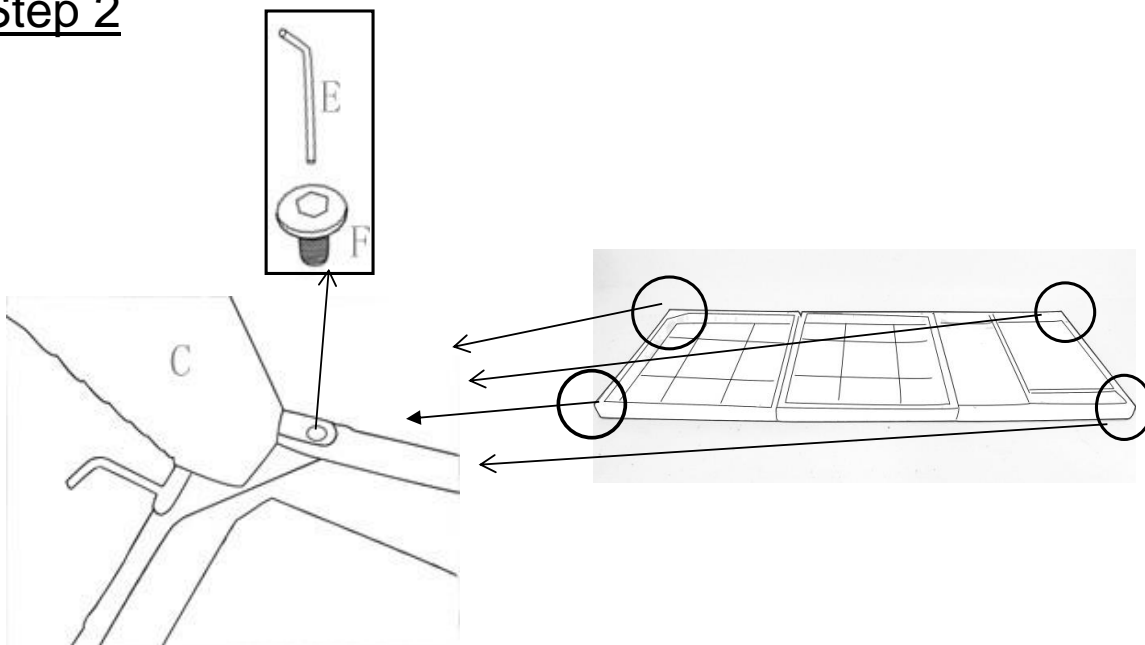

Attach Front&Back Leg((C) to the Seat Panel(A) using Bolt(F) with Allen Key(E).

DO NOT Tighten Bolts.

Step 3

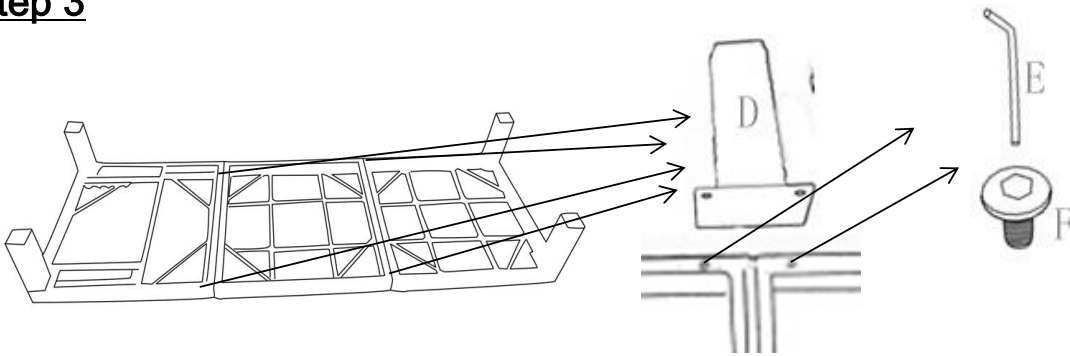

Attach Middle Leg((D) to the Seat Panel(A) using Bolt(F) with Allen Key(E).

Now, in a sequential manner, proceed to fully tighten all bolts at all joints.

Step 4

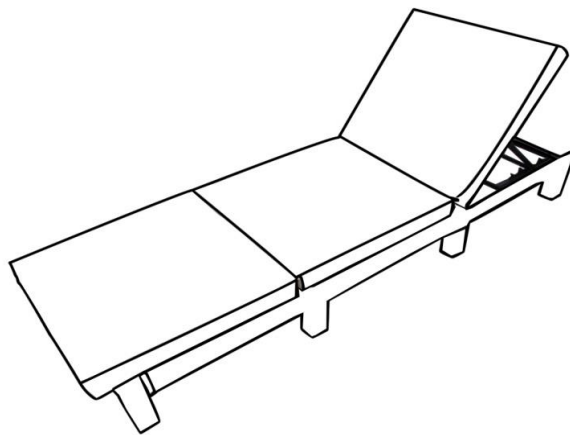



















Carefully, with assistance from a second Adult, place the Lounge to stand on its side.



Then stand the Lounge the right side up.

Place the Cushion(B) on the Lounge.

Your Chaise Lounge is ready for use.

Care & Maintenance

-   ● Do not put hot items directly on furniture surface
-   ● Do not clean furniture with harsh cleansers or polish.
-   ● To obtain the longest lifespan of your outdoor products, minimizing exposure to direct sunlight is recommended.
-   ● Children should not climb or jump on the furniture.
-   ● Do not write on furniture without a padded barrier to protect the surface.
-   ● To obtain the longest lifespan of your outdoor products, avoid extended and lengthy exposure to rain, snow, and direct sunshine. Whenever possible cover the product and /or place under patio or awnings.
-   ● Not for commercial use. For residential use only .
-   ● Stains may be removed with mild soap solution and damp cloth.
-   ● Keep away from sources of ignition.

-   ● Dust and pick-up spills using a clean, non-colored, lint-free cloth.