

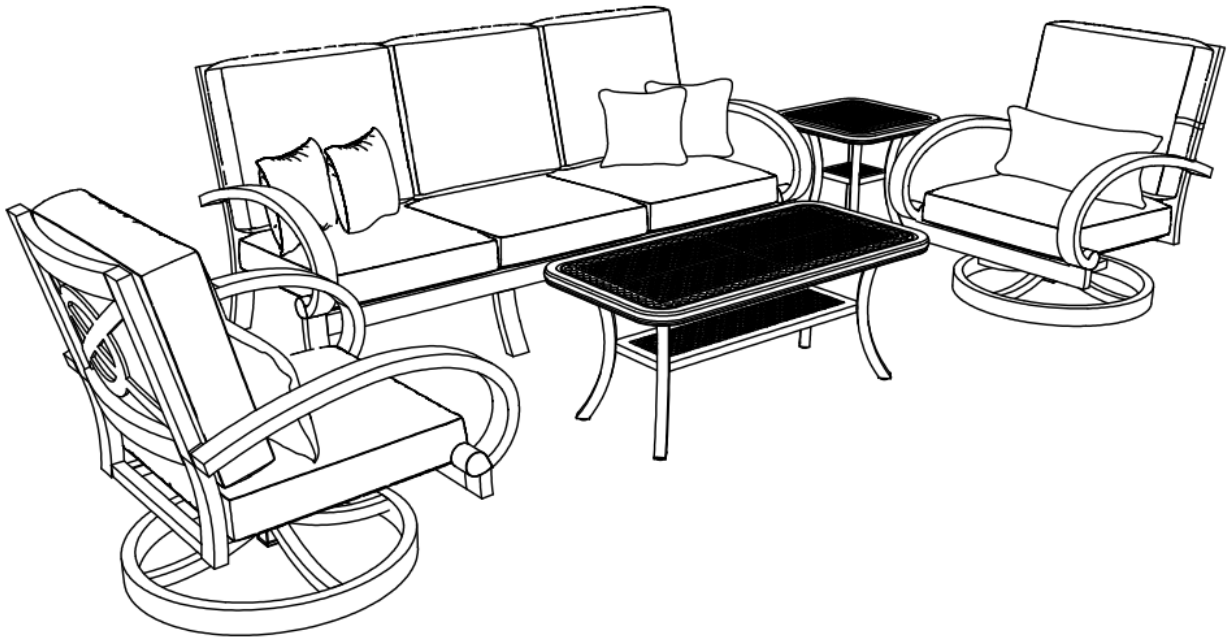

Pompeii 5pc Deep Seating Set



Item #.: 3502DS5PCRE

Customer Service

customerservice@americasbackyards.com

Monday - Friday, 9:00AM – 5:00PM CST











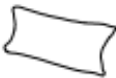

Toll Free: 1-888-910-5646 Fax: (832)-201-9138

www.americasbackyards.com

WARNING

Please read instructions carefully and thoroughly before assembling. Check parts against the parts list to make sure you have all the parts needed for proper assembly. Familiarize yourself with the inventory of parts and the accompanying illustrations to ensure safe and proper assembly. **DO NOT ATTEMPT TO ASSEMBLE IF PARTS ARE MISSING OR DAMAGED. IMPROPER ASSEMBLY MAY RESULT IN DAMAGE OR SERIOUS INJURY.**

Place the chair on a non-abrasive flat surface to prevent scratching.

PART #.	DESCRIPTION	PICTURE	QTY
A	Chair Seat		2
B	Chair Base		2
C	Lumbar Pillow		2
D	Back Cushion		2
E	Seat Cushion		2
F	Bolt		8
G	Metal Plate		8
H	Flat Washer		8
I	Lock Washer		8
J	Nut		8
K	Nut Cover		8
L	Wrench		1

1. Place the chair seat (A) on a non-abrasive flat surface. Align the holes on the support bar on the underside of the chair seat with the holes on the spring plates attached to the T-rocker that is pre-attached to the chair base (B). Make sure the arrow labels on the rocker mechanism and chair support bar are facing the same direction—towards the front of the chair. Insert bolts (F) through the metal plates (G), support bar, spring plate and the metal plates (G) as showed in the diagram. Secure bolts with flat washers (H), lock washers (I) and nuts (J). The support bar and spring plate should be sandwiched in between the metal plates (G).

Warning: Improper assembly may result in serious personal injury.

Once all the nuts and bolts are in place, securely tighten all the bolts (F) and nuts (J), including the ones at the front part on the rocker mechanism with the wrench (L). Cover all nuts with nut covers (K).

Place the seat cushion (E), back cushion (D) and lumbar pillow (C) on the swivel rocking club chair. Test the swivel rocker gently. If the rocker does not rock properly, double check the assembly procedure, especially step 1.

REPEAT ABOVE STEPS TO ASSEMBLE THE ANOTHER SWIVEL ROCKING CLUB CHAIR.



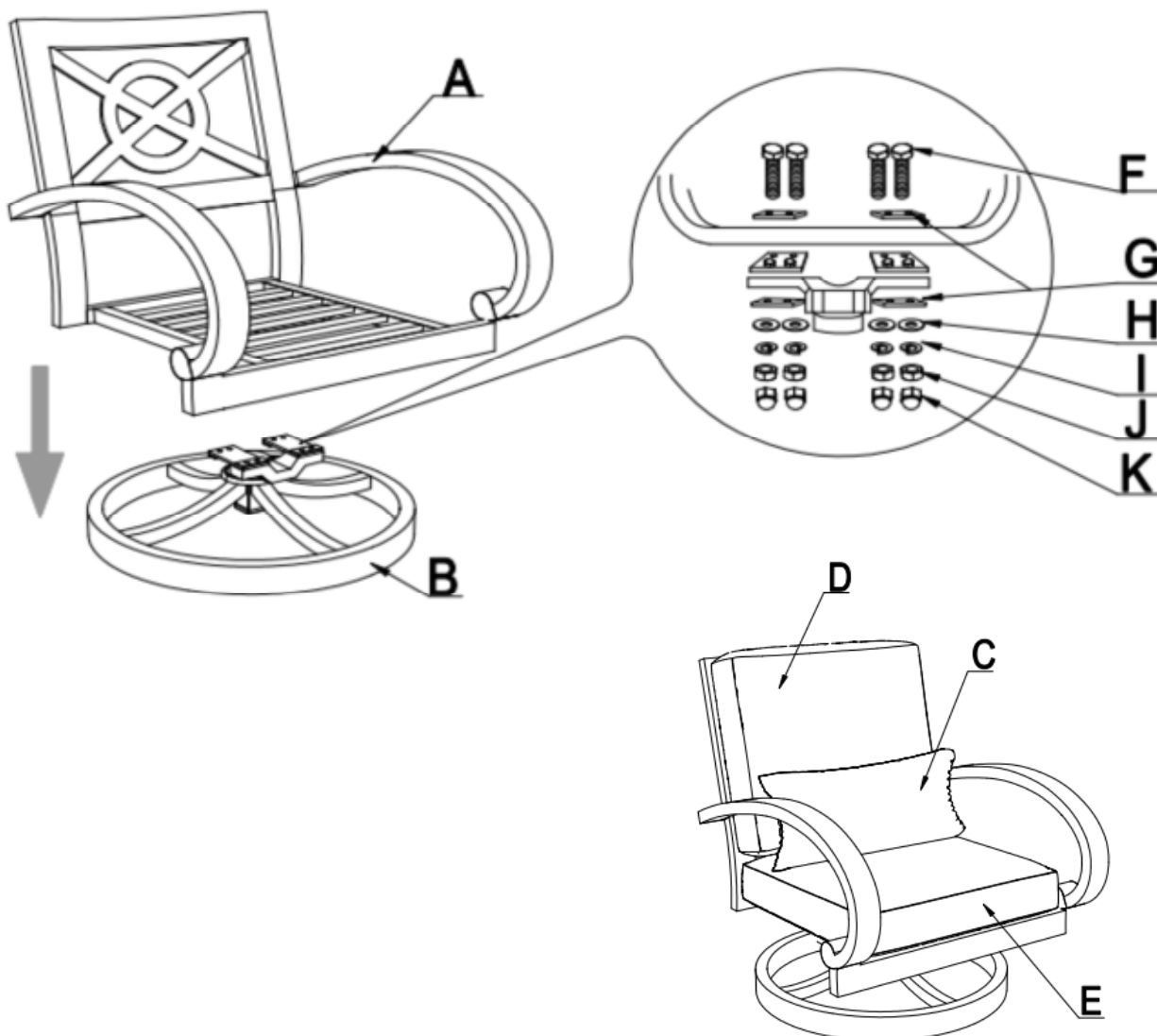





Your swivel rocking club chair is ready for enjoyment.



WARNING

Please read instructions carefully and thoroughly before assembling. Check parts against the parts list to make sure you have all the parts needed for proper assembly. Familiarize yourself with the inventory of parts and the accompanying illustrations to ensure safe and proper assembly. **DO NOT ATTEMPT TO ASSEMBLE IF PARTS ARE MISSING OR DAMAGED. IMPROPER ASSEMBLY MAY RESULT IN DAMAGE OR SERIOUS INJURY.**

Place the coffee table on a non-abrasive flat surface to prevent scratching.

PART #.	DESCRIPTION	PICTURE	QTY
A	Table Top		1
B	Leg Collecting Panel		1
C	Table Leg		4
D	Bolt		8
E	Flat Washer		8
F	Lock Washer		8
G	Nut		8
H	Nut Cover		8
I	Wrench		1

1. Place the table top (A) upside down on a non-abrasive flat surface. Align the holes in table legs (C) with the holes in the table top (A), Loosely secure table legs (C) to the table top (A) with bolt (D) through flat washer (E), lock washer (F) and nut (G). Do not tighten the bolts at this point.

2. Align the holes in table legs (C) with the holes in the leg collecting panel (B), Loosely secure the leg collecting panel (B) to table legs (C) with bolt (D) through flat washer (E), lock washer (F) and nut (G). Do not tighten the bolts at this point.

3. Check the alignment of all table legs (C), and adjust if necessary. Once the alignment is correct and all bolts are in place, Properly tighten all the bolts (D) and nuts (G) using wrench (I). Cover the nuts (G) with nut covers (H). Carefully turn the table to the upright position.



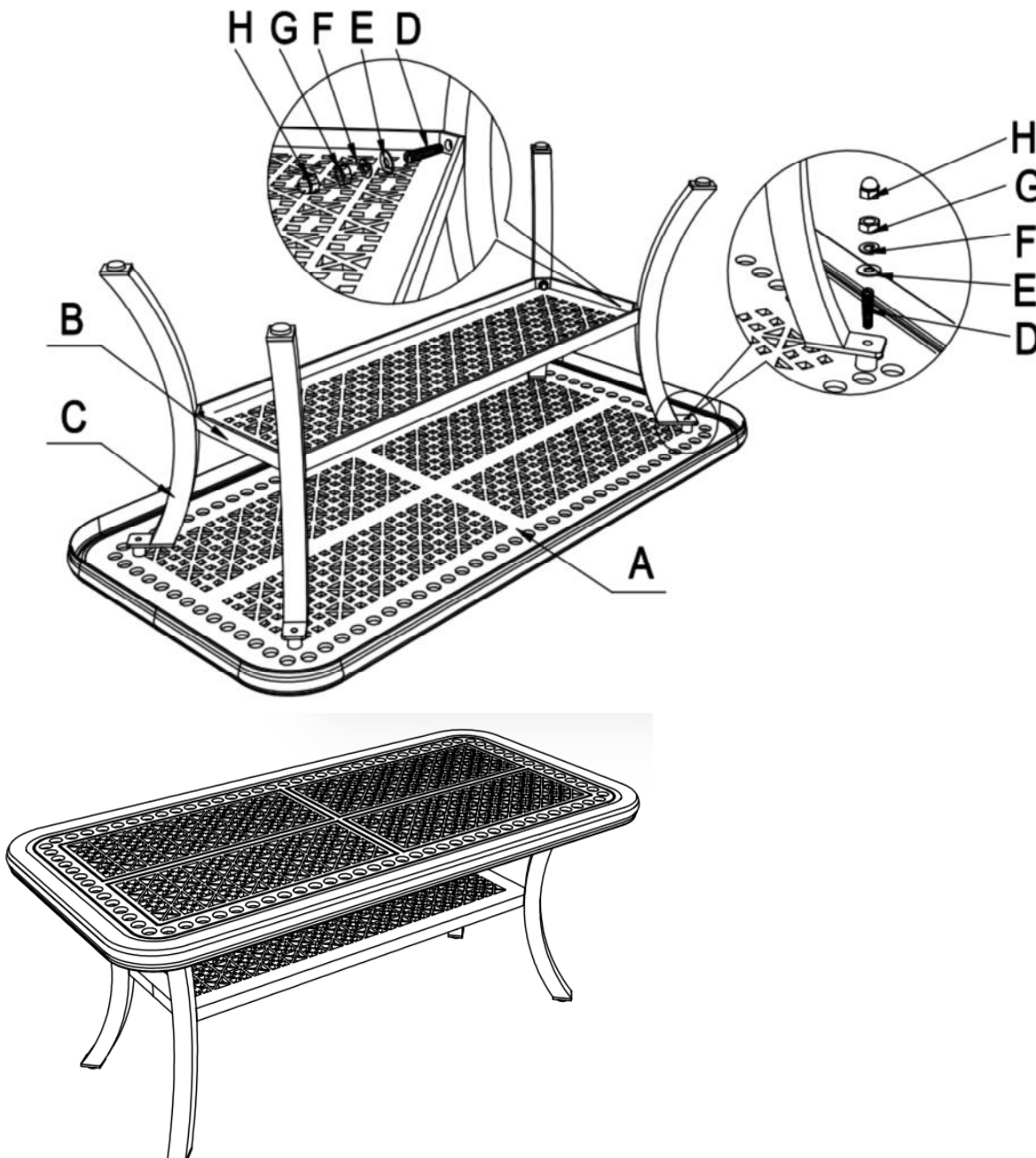





The coffee table is ready for your enjoyment.



WARNING

Please read instructions carefully and thoroughly before assembling. Check parts against the parts list to make sure you have all the parts needed for proper assembly. Familiarize yourself with the inventory of parts and the accompanying illustrations to ensure safe and proper assembly. **DO NOT ATTEMPT TO ASSEMBLE IF PARTS ARE MISSING OR DAMAGED. IMPROPER ASSEMBLY MAY RESULT IN DAMAGE OR SERIOUS INJURY.**

Place the side table on a non-abrasive flat surface to prevent scratching.

PART #.	DESCRIPTION	PICTURE	QTY
A	Table Top		1
B	Leg Collecting Panel		1
C	Table Leg		4
D	Bolt		8
E	Flat Washer		8
F	Lock Washer		8
G	Nut		8
H	Nut Cover		8
I	Wrench		1

1. Place the table top (A) upside down on a non-abrasive flat surface. Align the holes in table legs (C) with the holes in the table top (A), Loosely secure table legs (C) to the table top (A) with bolt (D) through flat washer (E), lock washer (F) and nut (G). Do not tighten the bolts at this point.

2. Align the holes in table legs (C) with the holes in the leg collecting panel (B), Loosely secure the leg collecting panel (B) to table legs (C) with bolt (D) through flat washer (E), lock washer (F) and nut (G). Do not tighten the bolts at this point.

3. Check the alignment of all table legs (C), and adjust if necessary. Once the alignment is correct and all bolts are in place, Properly tighten all the bolts (D) and nuts (G) using wrench (I). Cover the nuts (G) with nut covers (H). Carefully turn the table to the upright position.

The side table is ready for your enjoyment.

