

Stolik

100x60x42

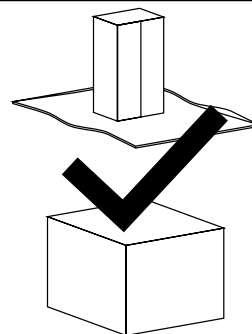

Nr	Nazwa elementu	D[mm]	S[mm]	G[mm]	Ilość
1	Blat	1000	600	18	1
2	Półka	920	520	18	1
3	Noga z Lamelami	400	150	36	4

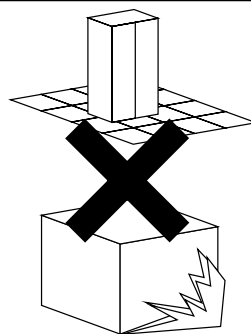
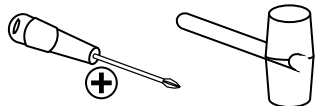
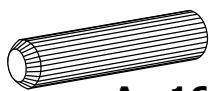
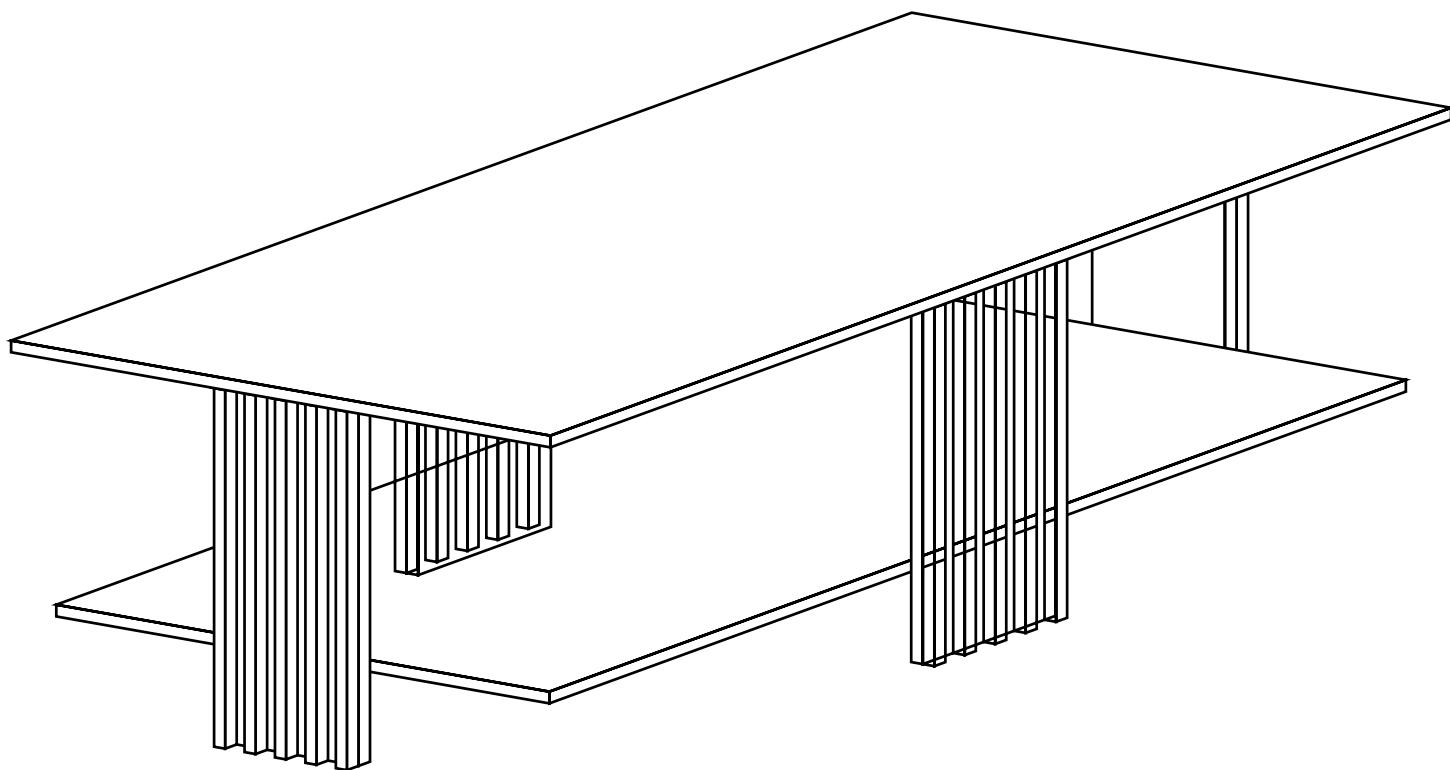

A - 16 Szt.

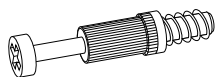

B - 16 Szt.

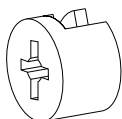

C - 16 Szt.

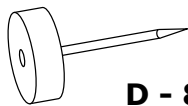

D - 8 Szt.



O - 1 Szt.



Z - 16 Szt.

I

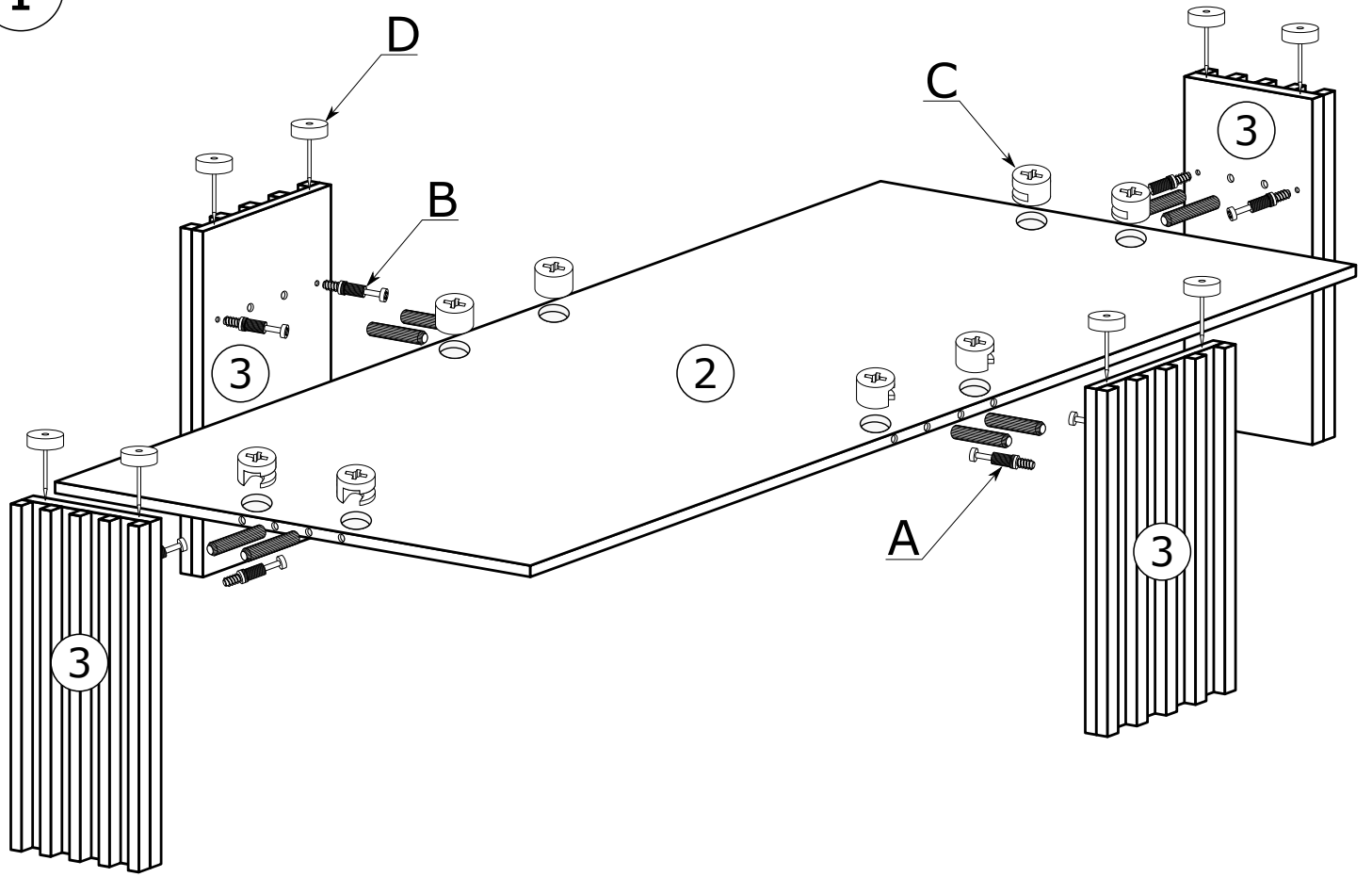

II

