

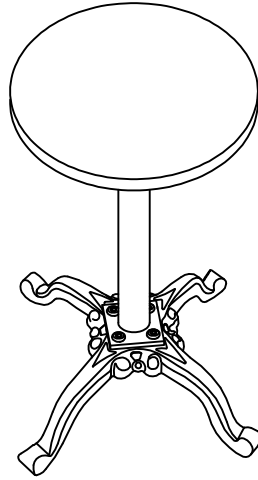

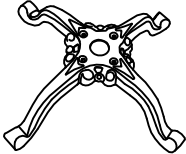

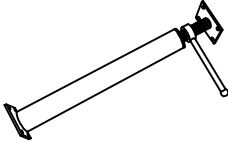

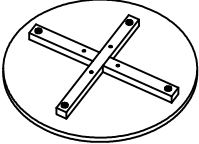

Assembly Instructions

18" ROUND ADJ. VINTAGE TABLE

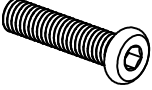

NO.	PART	DESCRIPTION	Q'TY	NO.	PARTS	DESCRIPTION	Q'TY
A		Base	1PC	B		Leg	1PC
C		TOP	1PC	D		Allen Head Bolt 1/4" × 5/8"	4PCS
E		Spring Washer Ø10	4PCS	F		Flat Washer Ø12*T1.0	4PCS
G		Allen Head Bolt 5/16" × 1"	4PCS	H		Flat Washer Ø20*T1.0	4PCS
J		Spring Washer Ø12	4PCS	K		Hexagonal Nut 5/16"	4PCS
L		Allen Head Wrench 4MM	1PC	M		Open-end Wrench	1PC

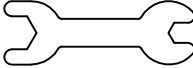
Assembly Instructions

18" ROUND ADJ. VINTAGE TABLE

STEP 1

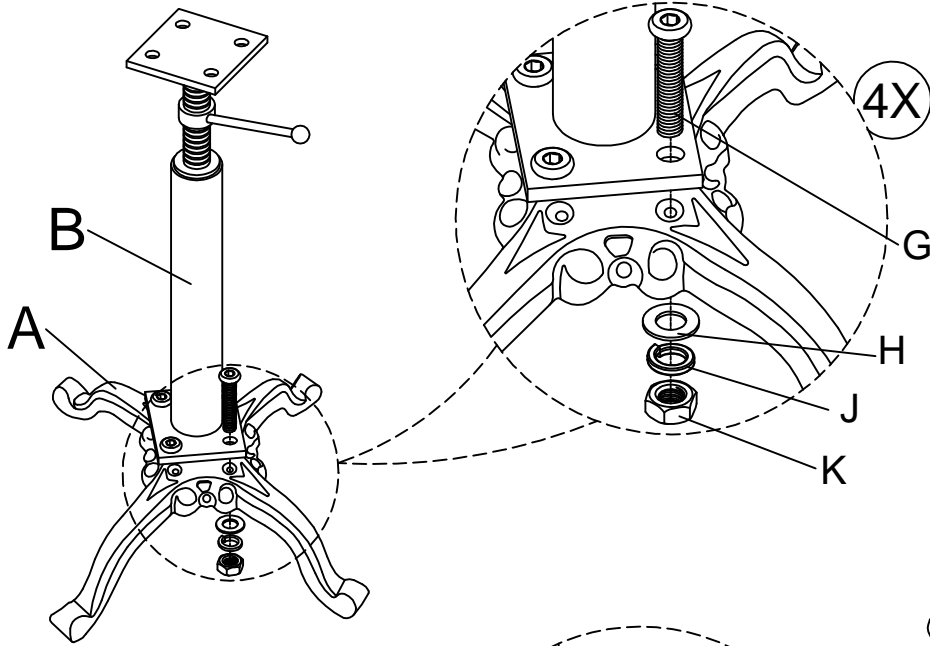

STEP 2

