

ASSEMBLY INSTRUCTION

Attention: Do not tighten the screws until all of them are in right positions
 Please contact us if you are missing any of the parts, or if you have a damaged part,
 Please let us know the part number, we will offer good solution asap.

Please attach your Order ID so that we can assist you better.

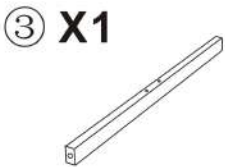
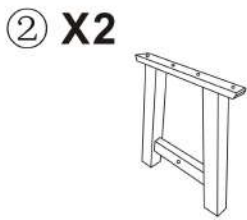
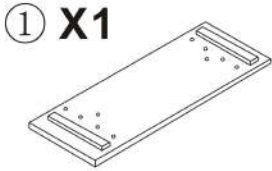

STEP 1

Assembly Tips:

You must not tighten any screw yet in this step

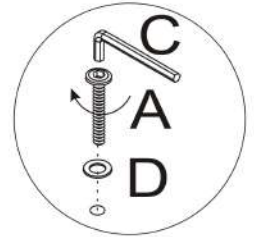
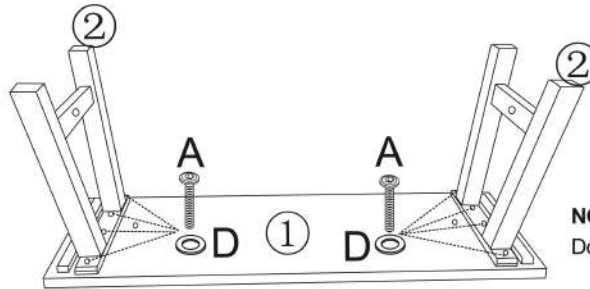

NOTE: Use 8 short #A 35MM screws,
Do NOT use #B screws

STEP 2

Assembly Tips:

You must not tighten any screw yet in this step

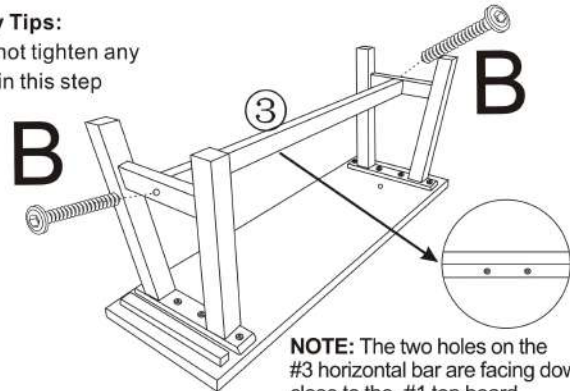
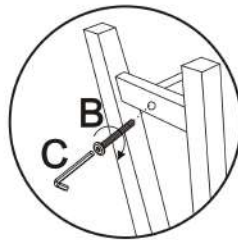

NOTE: Use 2 #B 40MM screws

NOTE: The two holes on the #3 horizontal bar are facing downward, close to the #1 top board

STEP 3

Assembly Tips:

You must not tighten any screw yet in this step

NOTE: Use 2 #A 35MM screws

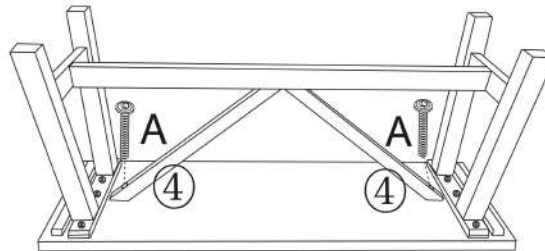

STEP 4

Assembly Tips: When every part is OK,
You can tighten all screws in this step.

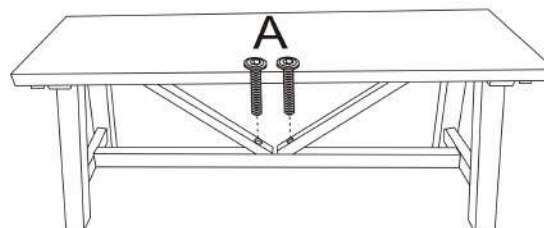

NOTE: Use 2 #A 35MM screws