



HELP CENTER

- ▶ Your full satisfaction is our FIRST priority.
- ▶ We hope you enjoy it and have a good shopping experience.
- ▶ We are committed to resolve any issue when the item does not meet your expectations.
- ▶ Please feel free to contact us through order detail page, we will get back to you and solve them within 24 hours.



WARNING:

Manufacturer and seller expressly disclaim any liability for personal injury, property damage, or loss, whether direct, indirect, or incidental, resulting from incorrect attachment, improper use, inadequate maintenance, or neglect of this.

ASSEMBLY INSTRUCTIONS

PLEASE RETAIN THIS INSTRUCTIONS FOR FUTURE REFERENCE

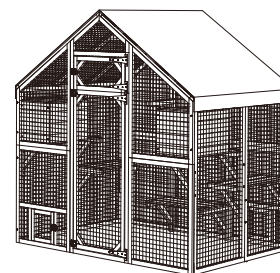
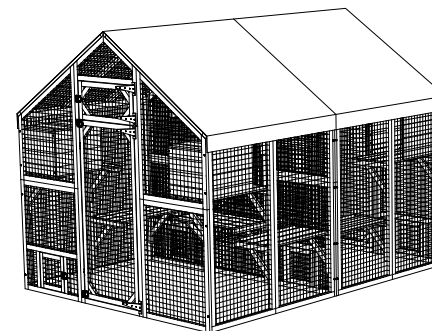

TIME: 60-90 minutes



NUMBER OF PEOPLE: 2

Greeting!
So here I am

your new pet house

- ▶ Thanks for letting me be a home for your furry friend(s).
- ▶ They'll be cozy and protected from the weather when they're with me.
- ▶ Just remember to take care of me too, so I can last a long time.
- ▶ When you open the box, you might smell a funny smell. Don't worry, it's not dangerous, just let me ventilate on the balcony or in a well-ventilated area for a few days and the smell will go away.
- ▶ Be careful when you assemble because some of my parts can be sharp or heavy. Make sure all the screws are tight during installation and double-check that they're all secure before using me.
- ▶ Please follow the instructions from my maker so your warranty stays good. If you are unsure about the assembly instructions in the manual, you can contact us for an assembly video if you need.
- ▶ Remember to place and use me on a flat surface to make sure it's put together correctly and works well.
- ▶ Keep me away from fire and dangerous chemicals.
- ▶ Clean me with a damp, soapy sponge without corrosive agents.
- ▶ Dry me with a soft, clean, dry cloth.
- ▶ Do not clean me with high pressure.
- ▶ Do not put bleach, acids, solvents, or abrasive cleaners on me.
- ▶ Check that all my bolts, screws, and knobs are tight every 90 days.

ASSEMBLY INSTRUCTIONS FOR TWO SETS CONNECTION

E M3.0*18 16PCS

J  8PCS

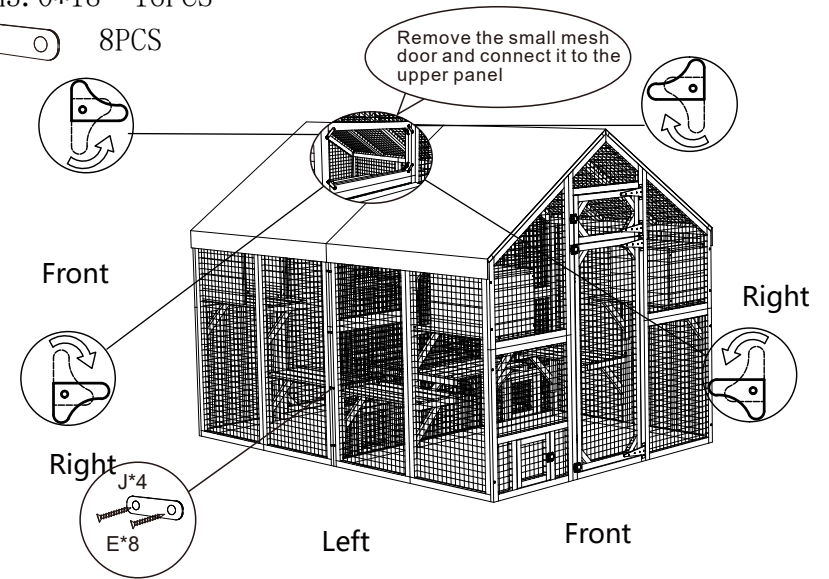

Connect the installed two products back to back, fix the (J)*4 connecting piece with screws.

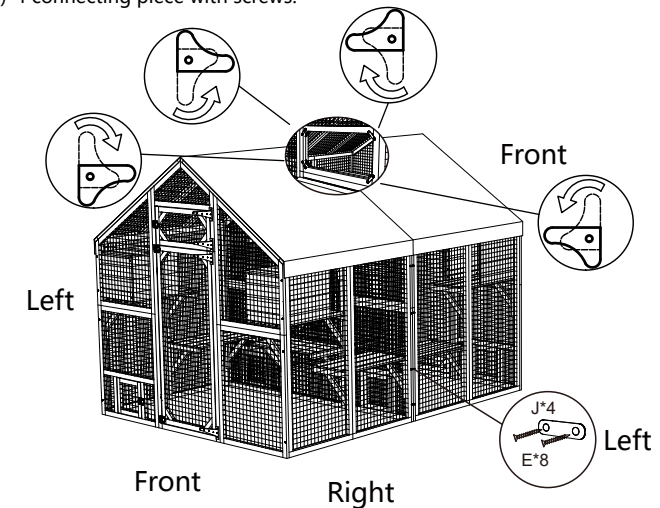

Connect the installed two products back to back, fix the (J)*4 connecting piece with screws.

K M3. 5*20 6PCS
 G   3PCS

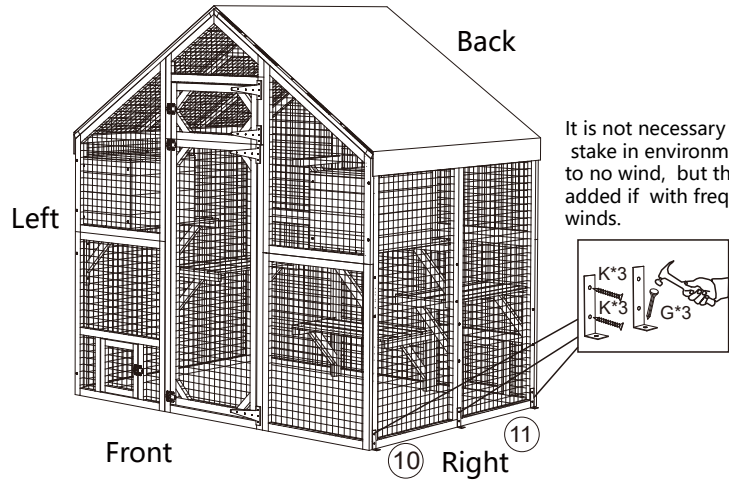

It is not necessary to add the tent stake in environments with little to no wind, but they should be added if with frequent strong winds.

Fix (G)*3 Tent stake on ①① Left right back panel and ⑩⑩ Right front panel with screws.

STEP 19

K M3. 5*20 6PCS
 G   3PCS

It is not necessary to add the tent stake in environments with little to no wind, but they should be added if with frequent strong winds.

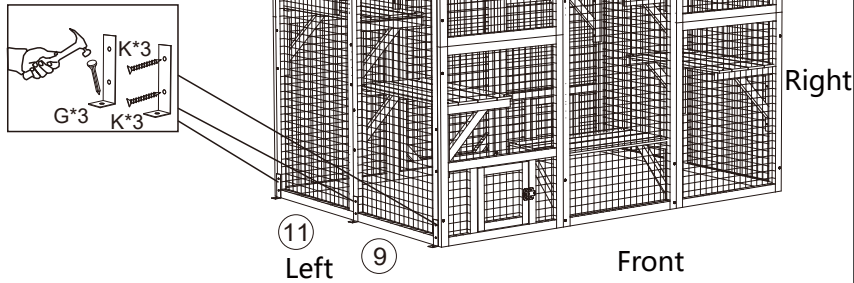

Fix (G)*3 Tent stake on ①① Left right back panel and ⑨⑨ Left front panel with screws.

STEP 20

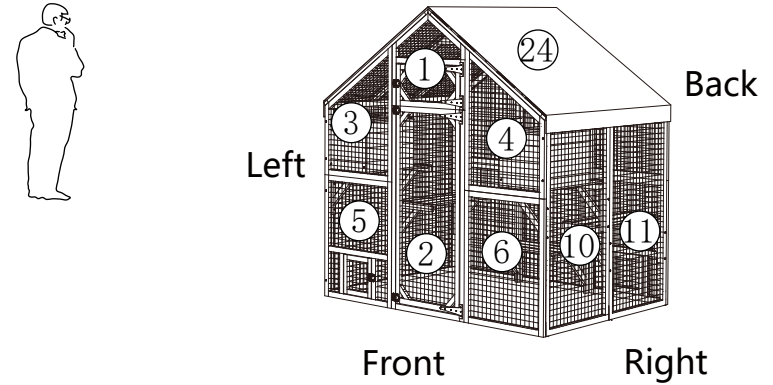
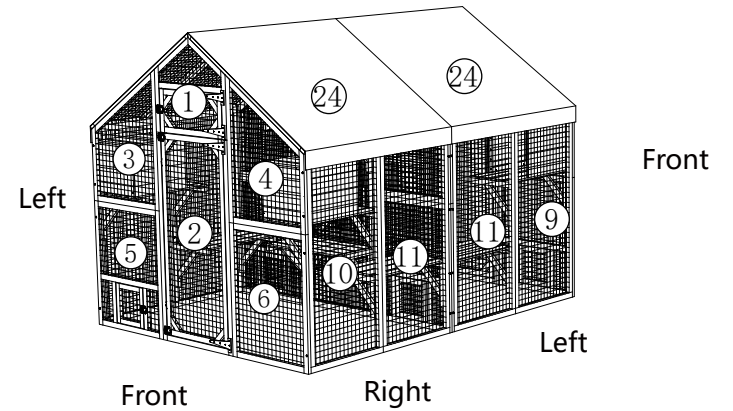

Carton Box 1/2: ③*2 ④*2 ⑤*2 ⑥*2 ⑩*4 ⑪*4 ⑬*2 .Hareware

Carton Box 2/2: ① ② ⑦ ⑧ ⑨ ⑩ ⑪*2 ⑫*2 ⑬*2 ⑭*2 ⑮*2 ⑯*2 ⑰*2
 ⑱*10 ⑲*2 ⑳*2 ㉔

ASSEMBLY INSTRUCTION

Tool Required:  Electric Drill  Phillips Screwdriver

CARTON 1/2

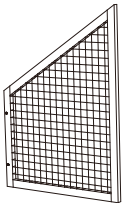
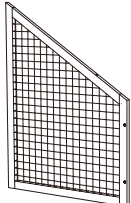
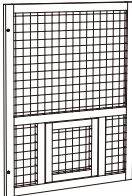
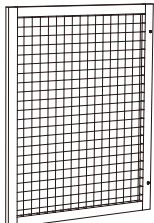
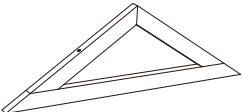
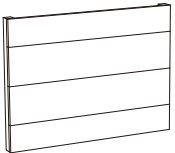
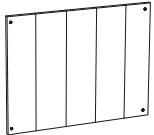
		
③ *2 Front back left upper panel	④ *2 Front back right upper panel	⑤ *2 Front back left down panel
		
⑥ *2 Front back right down panel	⑳ *4 Roof support	㉑ *4 Side panel of small house
		
㉓ *2 Cover of small house		

CARTON 2/2

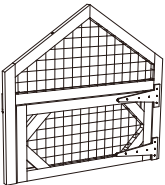
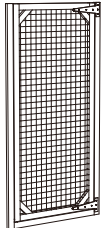
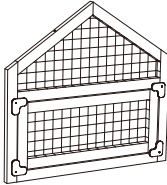
		
① Front upper panel	② Front down panel	⑦ Back upper panel

B M3.5*45 9PCS

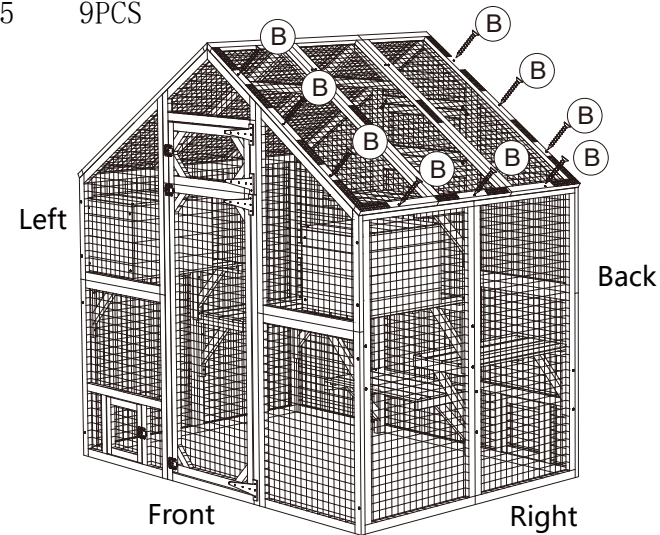

Attach the assembled roof to the main house and secure it with screws.

STEP 17

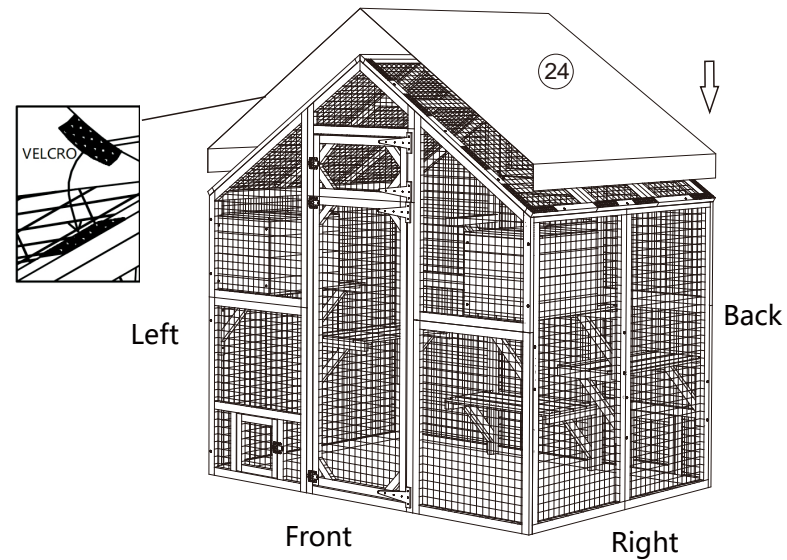

Put on ㉔ Cover.

STEP 18

B M3. 5*45 4PCS

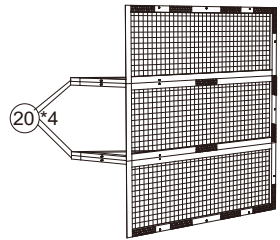
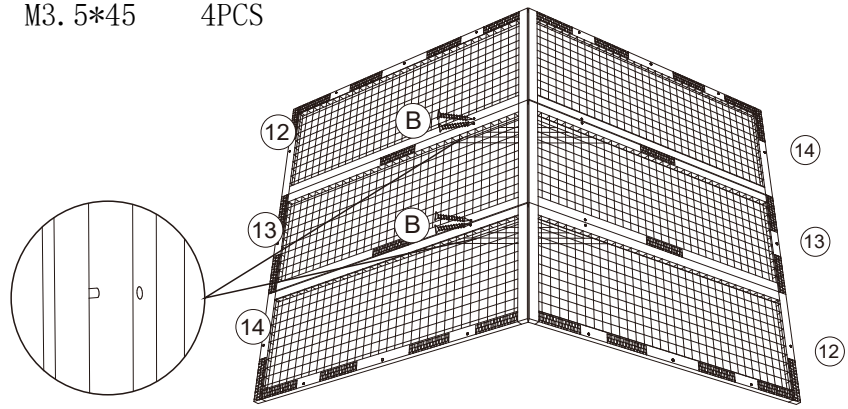

Fix 20*4 Roof support on 12 Roof 13 Roof 14 Roof with screws.

STEP 15

B M3. 5*45 9PCS

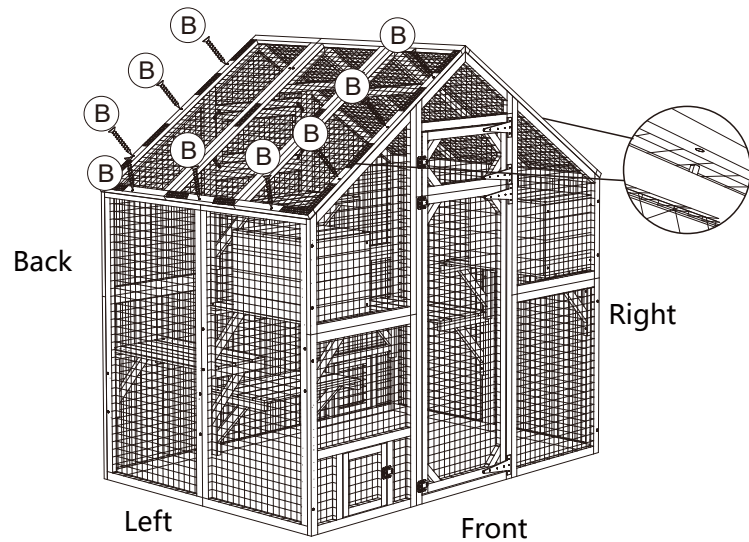

Attach the assembled roof to the main house and fix with screws.

STEP 16

ASSEMBLY INSTRUCTION

Tool Required: Electric Drill Phillips Screwdriver

CARTON 2/2

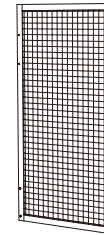

8 Back down panel



9 Left front panel



10 Right front panel



11 *2 Left right back panel



12 *2 Roof

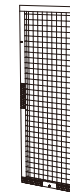

13 *2 Roof

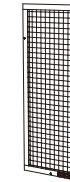

14 *2 Roof

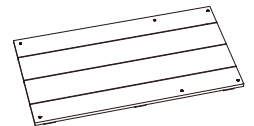

15 *2 Layer panel

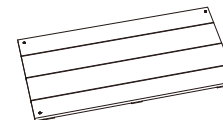

16 *2 Side layer panel



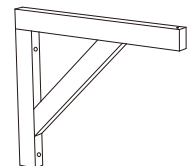

17 *2 Back layer panel



18 *10 Triangular support

ASSEMBLY INSTRUCTION

Tool Required:  Electric Drill  Phillips Screwdriver

CARTON 2/2

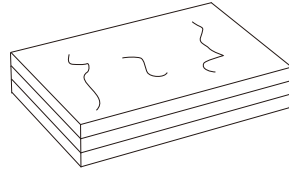
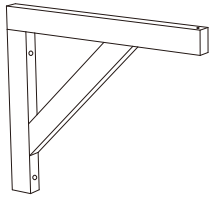











①⑨ *2 Triangular support

②② *2 Back panel of small house

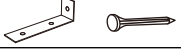
②④ cover

Parts Description

	A M3.5*60	48PCS+1
	B M3.5*45	44PCS+1
	C M6.0*60	24PCS
	D M3.0*23	44PCS+1
	E M3.0*18	16PCS+1
	F M6.0*20	16PCS
	G	6PCS
	H M3.0*14	20PCS+1
	I	5PCS
	J	8PCS
	K M3.5*20	12PCS+1

A M3.5*60 8PCS

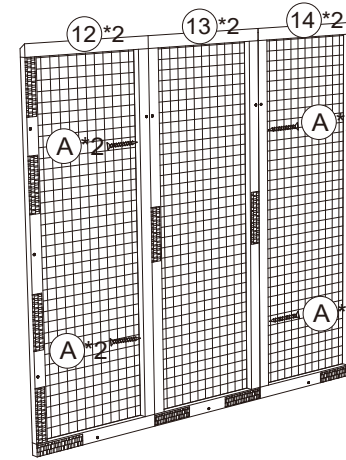

Attach ⑫*2 Roof ⑬*2 Roof ⑭*2 Roof together with screws.

STEP 13

B M3.5*45 4PCS

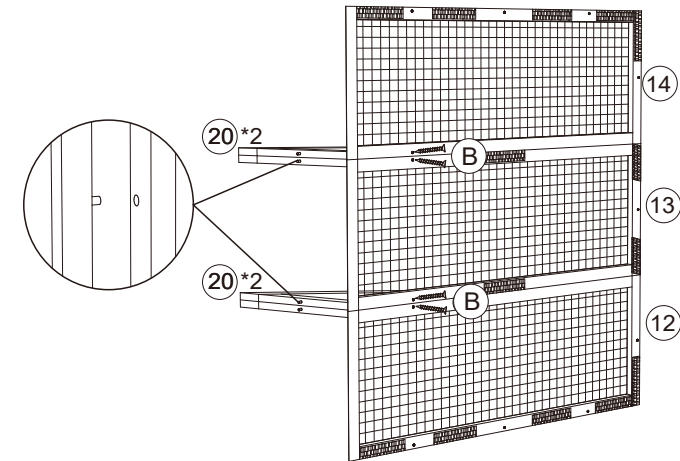

Fix ⑳*4 Roof support on ⑫ Roof ⑬ Roof ⑭ Roof with screws.

STEP 14

- B M3.5*45 2PCS
- D M3.0*23 4PCS

Internal installation steps

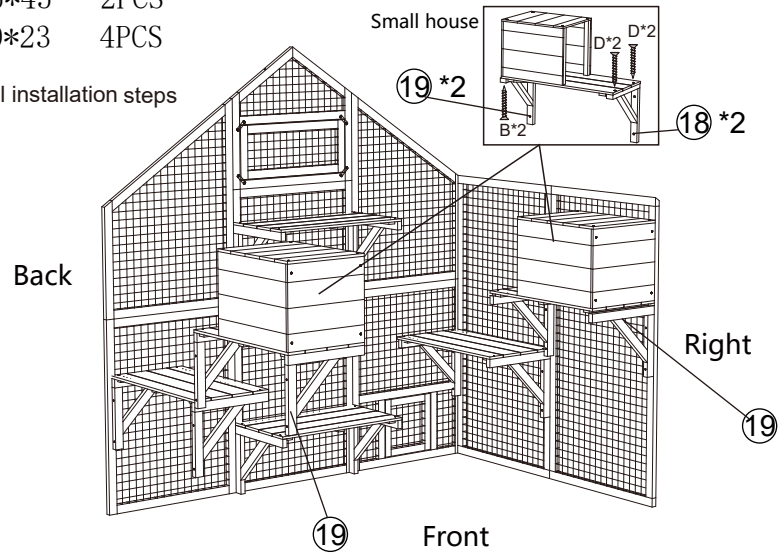

Fix small house on 18*2 Triangular support and 19*2 Triangular support with screws.

STEP 11

- B M3.5*45 8PCS

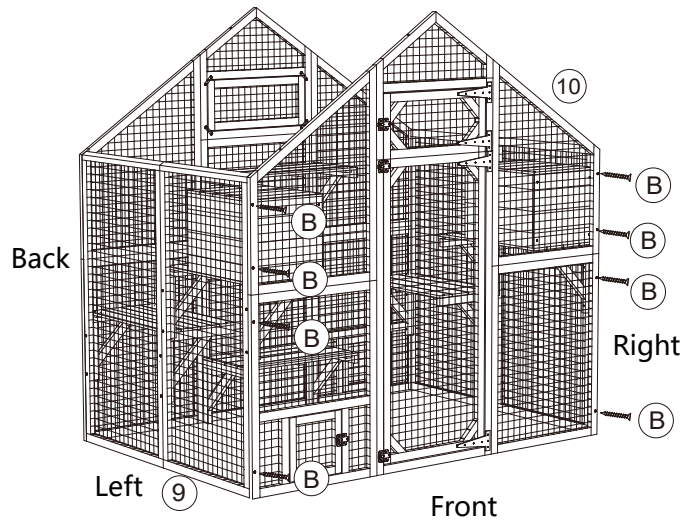

Fix the assembled front panel on 9 Left front panel and 10 Right front panel with screws.

STEP 12

- F 8PCS

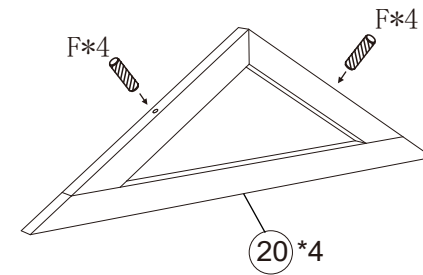

Fix(F)*8 Wood core on 20*4 Roof support.

STEP 1

- A M3.5*60 4PCS
- H M3.0*14 8PCS

- I 2PCS

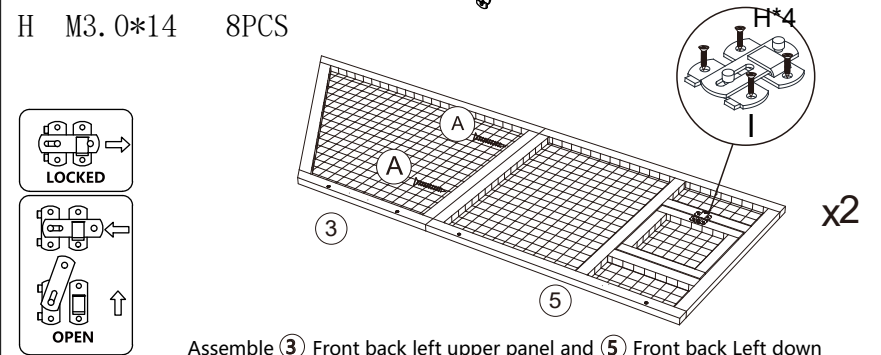

Assemble 3 Front back left upper panel and 5 Front back Left down panel with screws, fix(I)*2 Latch on 5 Front back left down panel with screws.

STEP 2

- A M3.5*60 4PCS

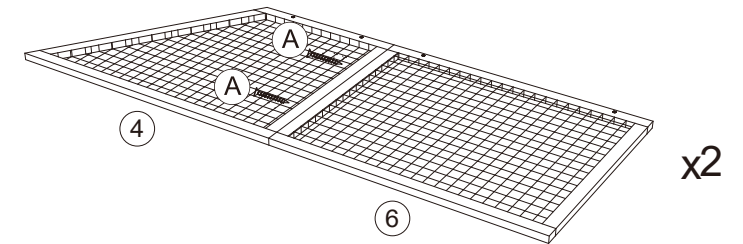

Assemble 4 Front back right upper panel and 6 Front back right down panel with screws.

STEP 3

A M3.5*60 14PCS

F  4PCS

H M3.0*14 12PCS

I  3PCS

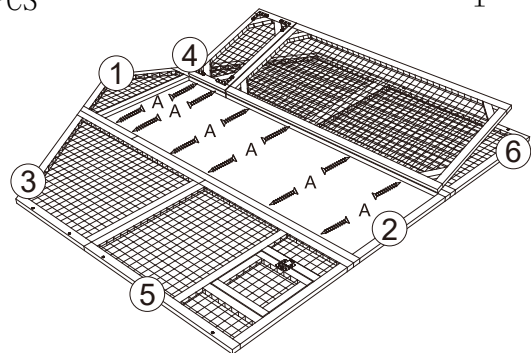

Assemble ① Front upper panel , ② Front down panel ,
③ Front back left upper panel, ④ Front back right upper panel,
⑤ Front back Left down panel and ⑥ Front back Right down panel
with screws.

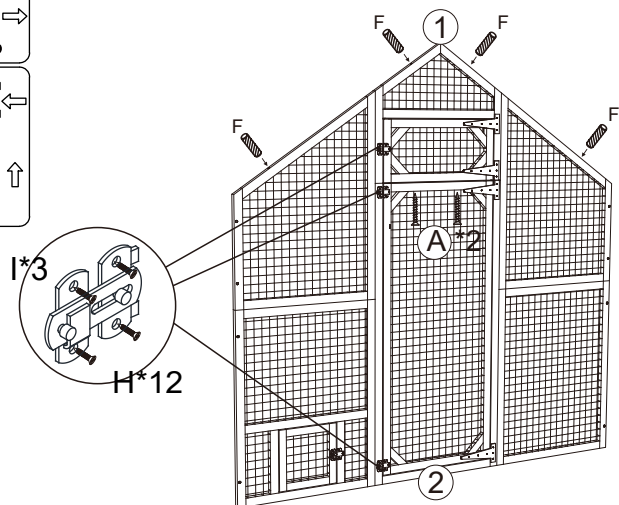
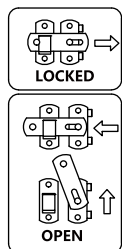

Fix (I)*3 Latch on ① Front upper panel and ② Front down panel ,
then insert (F)*4 Wood core.

STEP 4

D M3.0*23 16PCS

Internal installation steps

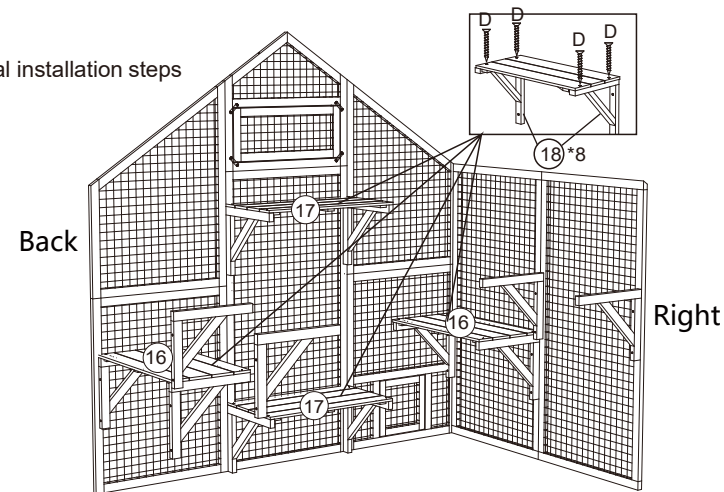

Fix ①⑦*2 Back layer panel , ①⑥*2 Side layer panel on
①⑧*8 Triangular support with screws.

STEP 9

D M3.0*23 24PCS

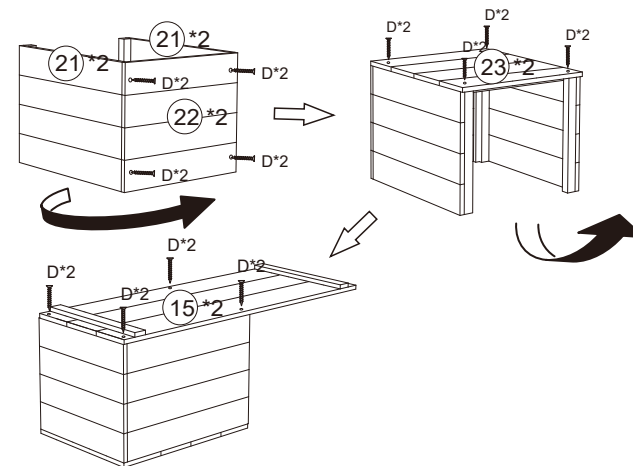

Assemble ②①*4 Side panel of small house and ②②*2 Back panel of small house with screws,
Insert ②③*2 Cover of small house with screws, then fix ①⑤*2 Layer panel with screws.

STEP 10

B M3.5*45 8PCS

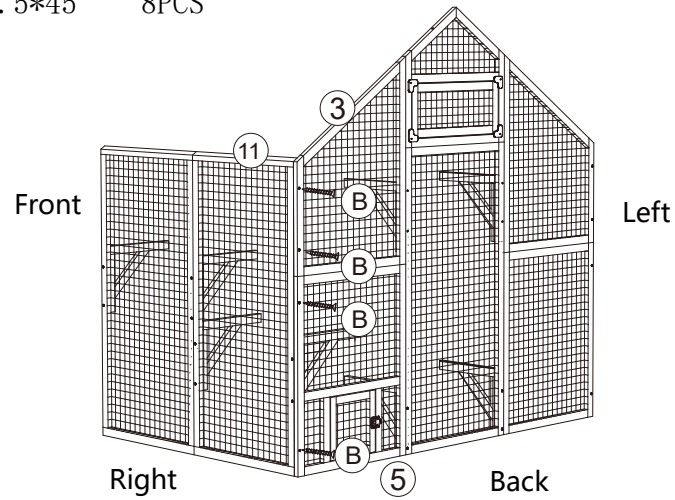

Attach ①① Left right back panel, ③ Front back left upper panel, ⑤ Front back Left down panel together with screws.

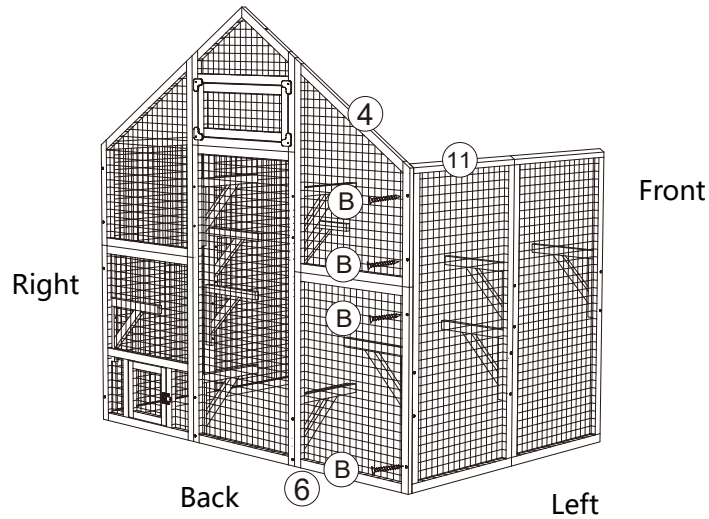

Attach ①① Left right back panel, ④ Front back right upper panel, ⑥ Front back Right down panel with screws.

STEP 8

A M3.5*60 12PCS

F  4PCS

C M6.0*60 8PCS

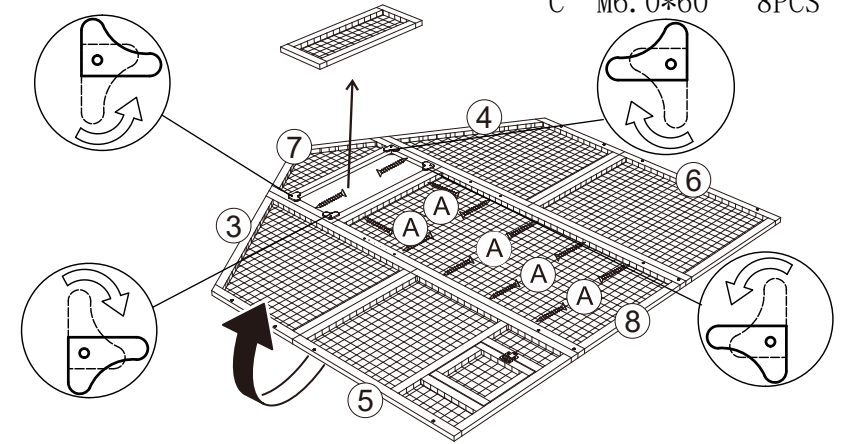

Assemble ③ Front back left upper panel, ④ Front back right upper panel, ⑤ Front back left down panel, ⑥ Front back Right down panel, ⑦ Back upper panel and ⑧ Back down panel with screws.

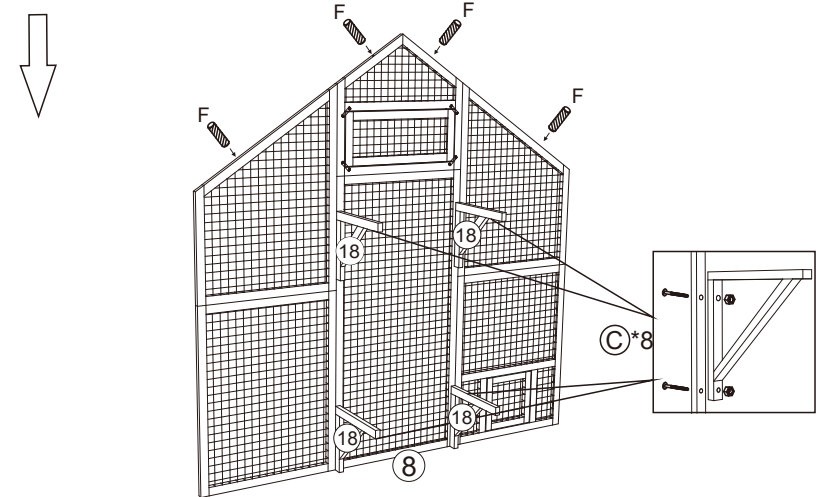

Fix ⑱*④ Triangular support on ⑧ Back down panel with screws, then insert (F)*④ Wood core.

STEP 5

- A M3. 5*60 3PCS
- C M6. 0*60 8PCS

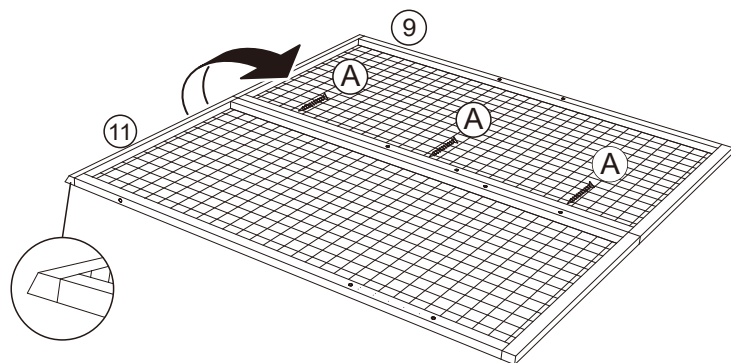

Assemble ⑪ Left right back panel and ⑨ Left front panel with screws.

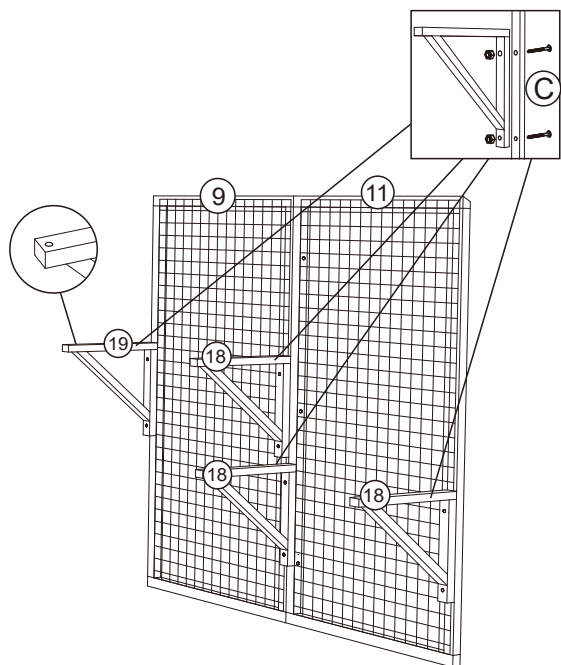

Fix ⑲ Triangular support , ⑱*3 Triangular support on ⑨ Left front panel and ⑪ Left right back panel with screws.

STEP 6

- A M3. 5*60 3PCS
- C M6. 0*60 8PCS

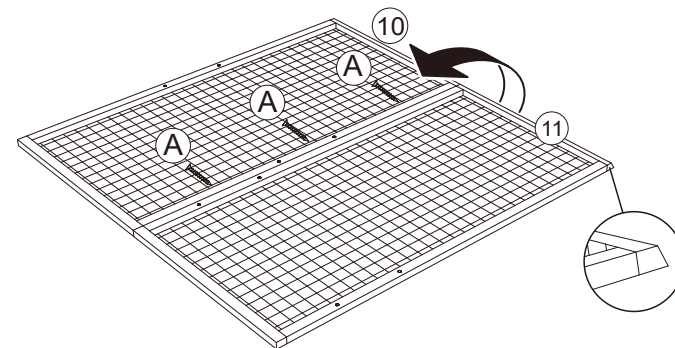

Assemble ⑪ Left right back panel and ⑩ Right front panel with screws.

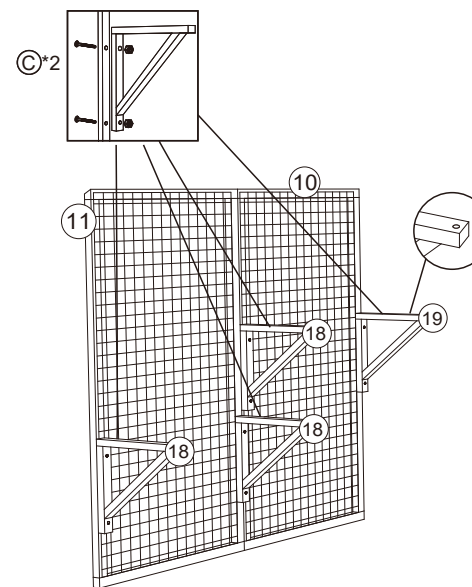

Fix ⑲ Triangular support , ⑱*3 Triangular support on ⑪ Left right back panel and ⑩ Right front panel with screws.

STEP 7