

## OPTIONAL PART ASSEMBLY INSTRUCTIONS

**Thank you for purchasing our product!**

1. Please use Assembly Instructions with title:

**ITEM #30002 BISTRO SPLIT DINING TABLE(with no CENTER PANEL)**

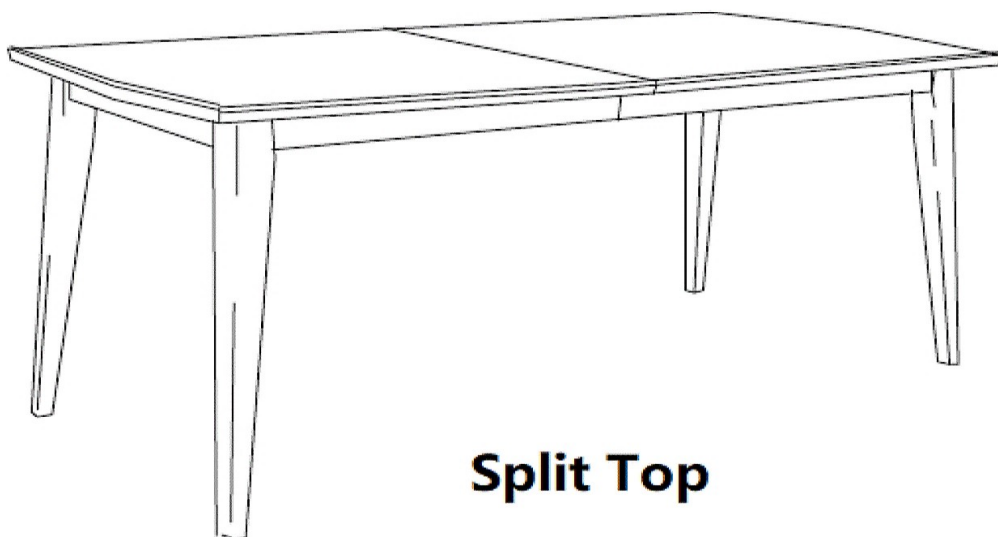

**Split Top**

# ASSEMBLY INSTRUCTIONS

## ITEM # 30002 BISTRO SPLIT DINING TABLE(with no CENTER PANEL)

Please read instructions carefully.

Remove all wrapping materials, staples and packing straps from the carton. Refer to Parts List and Hardware List and ensure they are complete before you start assembling. Place all wooden parts on a clean, flat and soft surface (e.g carpet or rug) to prevent parts from being scratched.









CAUTIONS:

- 1) DO NOT FULLY TIGHTEN BOLTS AND NUTS UNTIL ALL PARTS HAVE BEEN ASSEMBLED.
- 2) DO NOT OVER-TIGHTEN BOLTS AND NUTS UNTIL ALL PARTS HAVE BEEN ASSEMBLED.
- 3) KEEP ALL HARDWARE PARTS OUT OF REACH CHILDREN.

### PARTS LIST

	PARTS	QTY.
P1	TABLE TOP	2
P2	LEGS	4
P3	SUB-APRON	2
P4	SUPPORT BAR	1

### HARDWARE LIST

	DESCRIPTION	QTY.
H1	M8 x 60mm JCBC SCREW 	8
H2	M8 SPRING WASHER 	8
H3	M8 FLAT WASHER 	8
H4	M5 ALLEN KEY 	1
H5	M6 x 35mm JCBC SCREW 	16
H6	M6 SPRING WASHER 	12
H7	M6 FLAT WASHER 	12
H8	M4 ALLEN KEY 	1
H9	NAIL LEG 	4



COMPLETE ASSEMBLY

## STEP 1

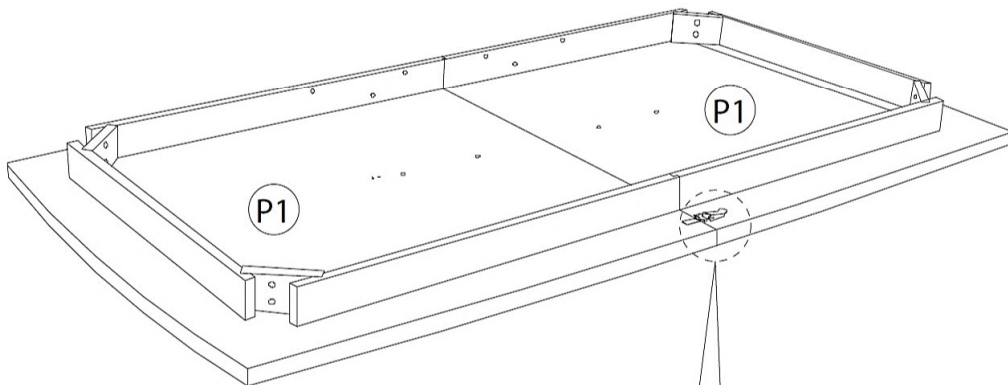

Attach both Table Tops (P1) together tightly before locking the latches.

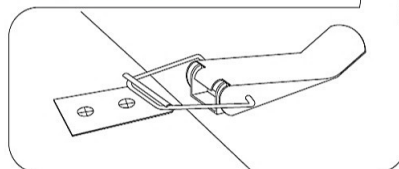

Lock all 2 latches



## STEP 2

H5 x 6	
M6 x 35mm	
H6 x 6	
H7 x 6	

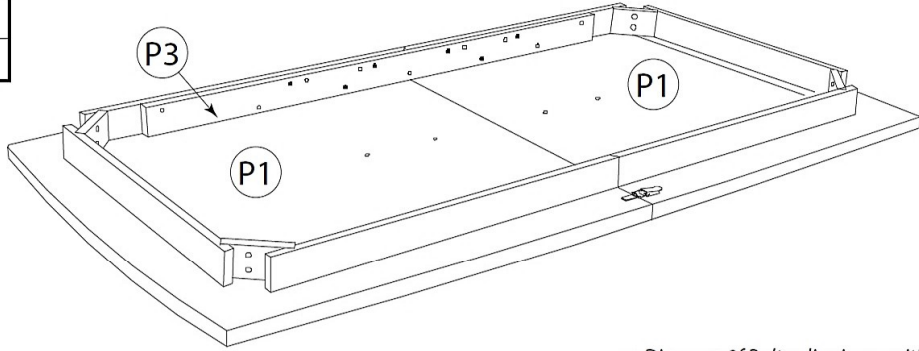

Mount the Sub-Aprons (P3) to the Table Aprons: Please see a diagram in the next page showing the position of holes to align the Bolts (H5) together Spring Washer (H6) & Flat Washer (H7) into the nuts in the Table aprons. Tighten all the bolts by using Allen Key (H8).

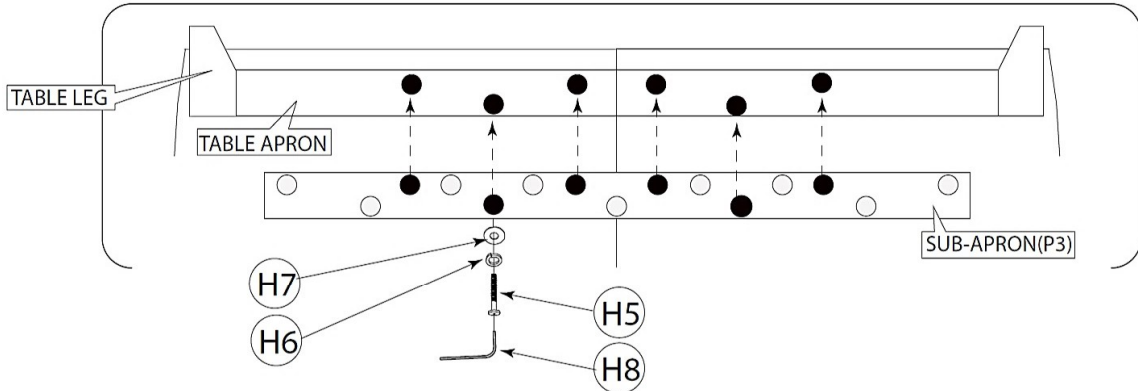

● Diagram Of Bolts aligning position to the Aprons



## STEP 3

H5 x 6	
M6 x 35mm	
H6 x 6	
H7 x 6	

Mount the Sub-Aprons (P3) to the other side of Table Aprons: Please see a diagram in the next page showing the position of holes to align the Bolts (H5) together Spring Washer (H6) & Flat Washer (H7) into the nuts in the Table aprons.

Tighten all the bolts by using Allen Key (H8).

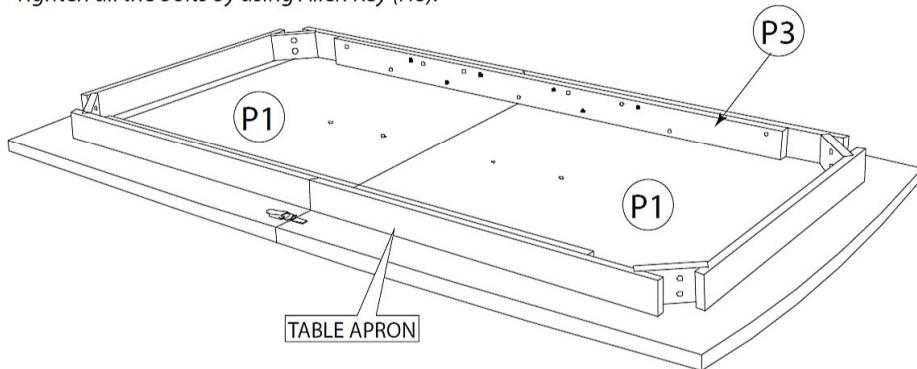

● Diagram Of Bolts aligning position to the Aprons

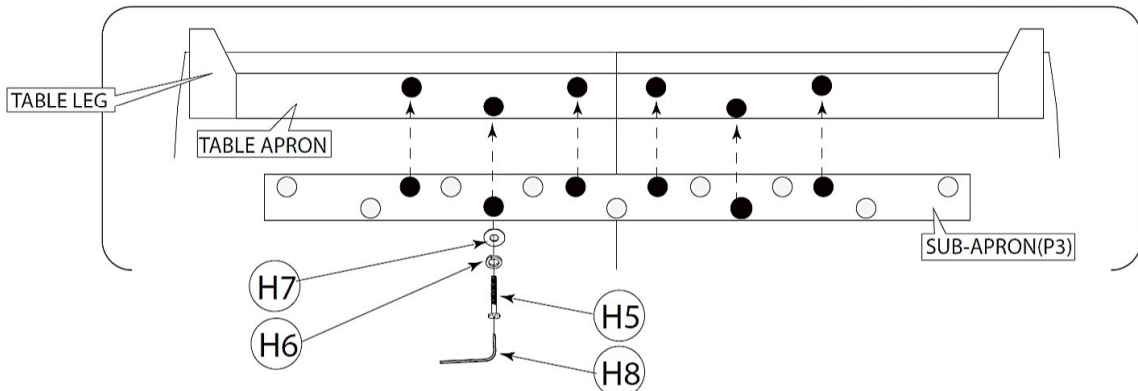

## STEP 4

H5 x 4

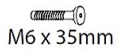

Mount the Support Bar (P4) to the underside of Table top: Please see a diagram aboveshowing the position of holes to align the Bolts (H5) into the nuts in the Table top. Tighten all the bolts by using Allen Key (H8).

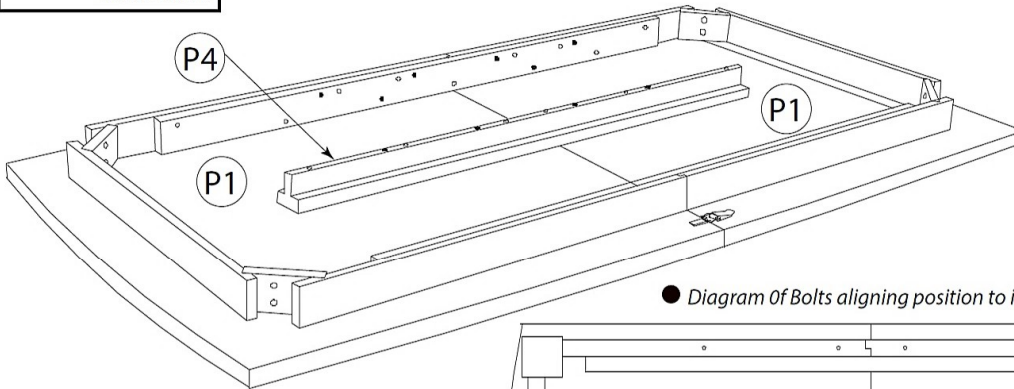

● Diagram Of Bolts aligning position to install the Support Bar (P4)

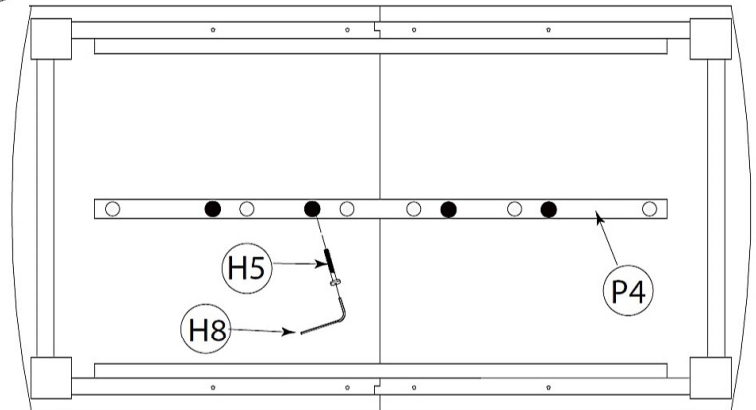

## STEP 5

H1 x 8

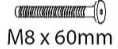

H2 x 8



H3 x 8



Assemble the Leg (P2) by aligning Bolts (H1) together Spring Washer (H2) & Flat Washer (H3) through holes in the corner blocks.

Tighten all the bolts by using Allen Key (H4).

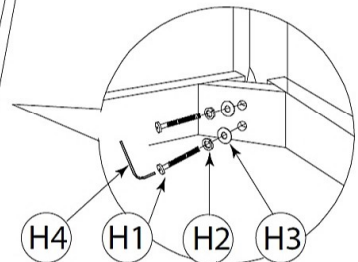
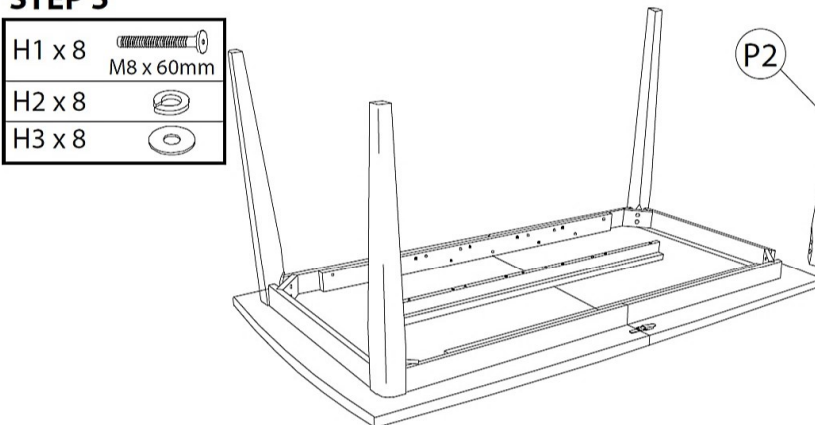

## STEP 6

Install the Nail Legs (H9) to the underside of each leg,

H9 x 4

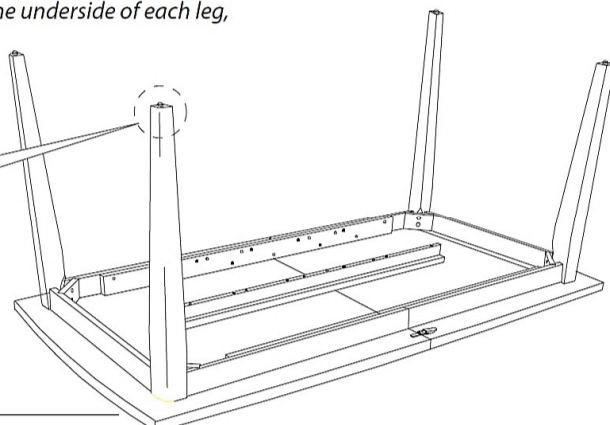
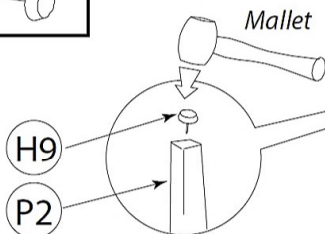

Carefully put the table upright by two or more adults person.

### CARE AND MAINTENANCE

#### SAFETY

#### CLEANING

#### FITTINGS

- To avoid any risk of suffocation to children and animals, dispose off plastic bags immediately.
- Clean with damp cloth and mild detergent. Do not use bleach or abrasive products.
- tighten bolts and nuts from time to time to ensure all parts of product are securely fitted.