

King Bed

Assembly Instructions

1 Assembled View

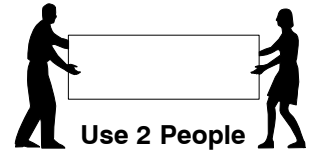
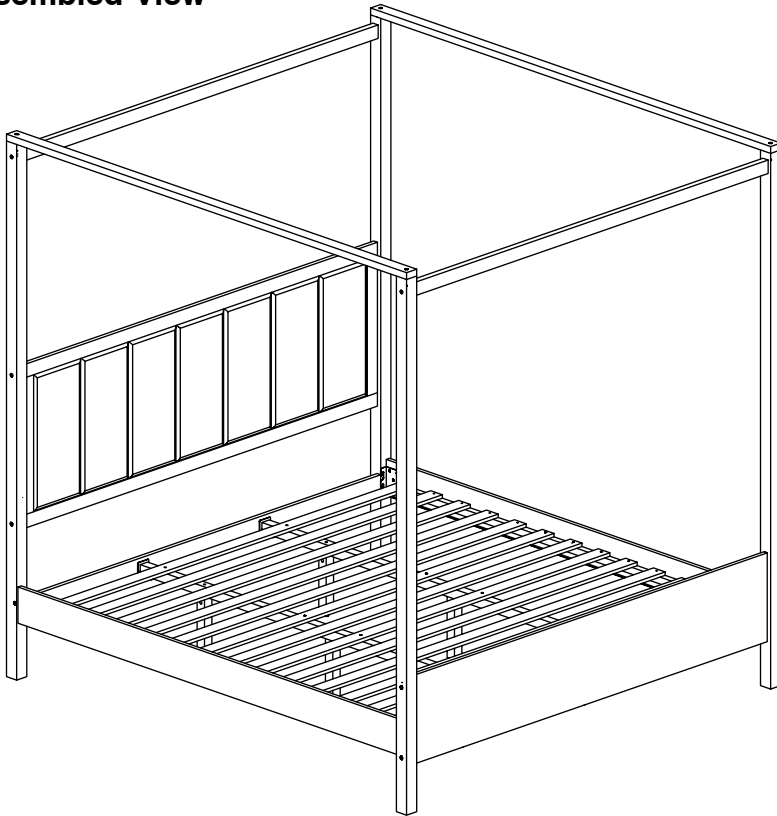

Note: Do not assemble using power tools. This can cause the bolts to be overtightened

2 Parts List

Parts in Box A:

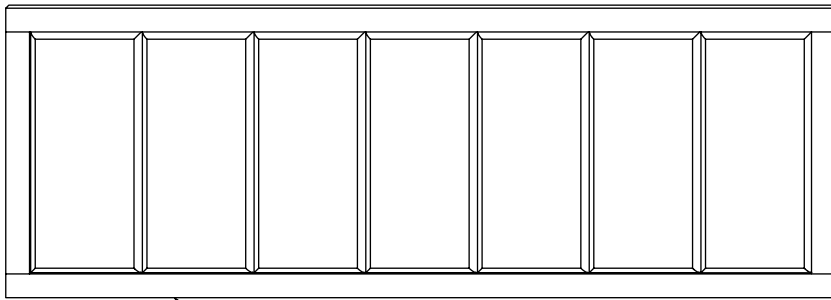

A Headboard Panel x 1

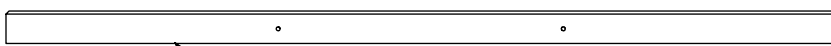

B Headboard Support x 1

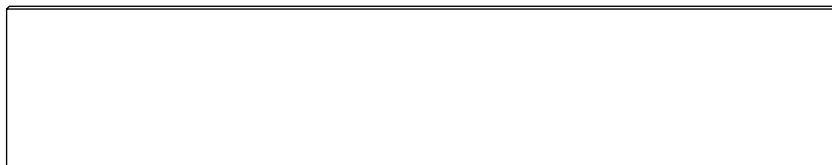

C Footboard Panel x 1

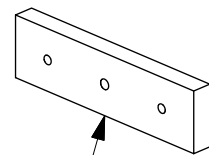

D Footboard Support Bar x 2

King Bed

Assembly Instructions

2 Parts List

Parts in Box B:

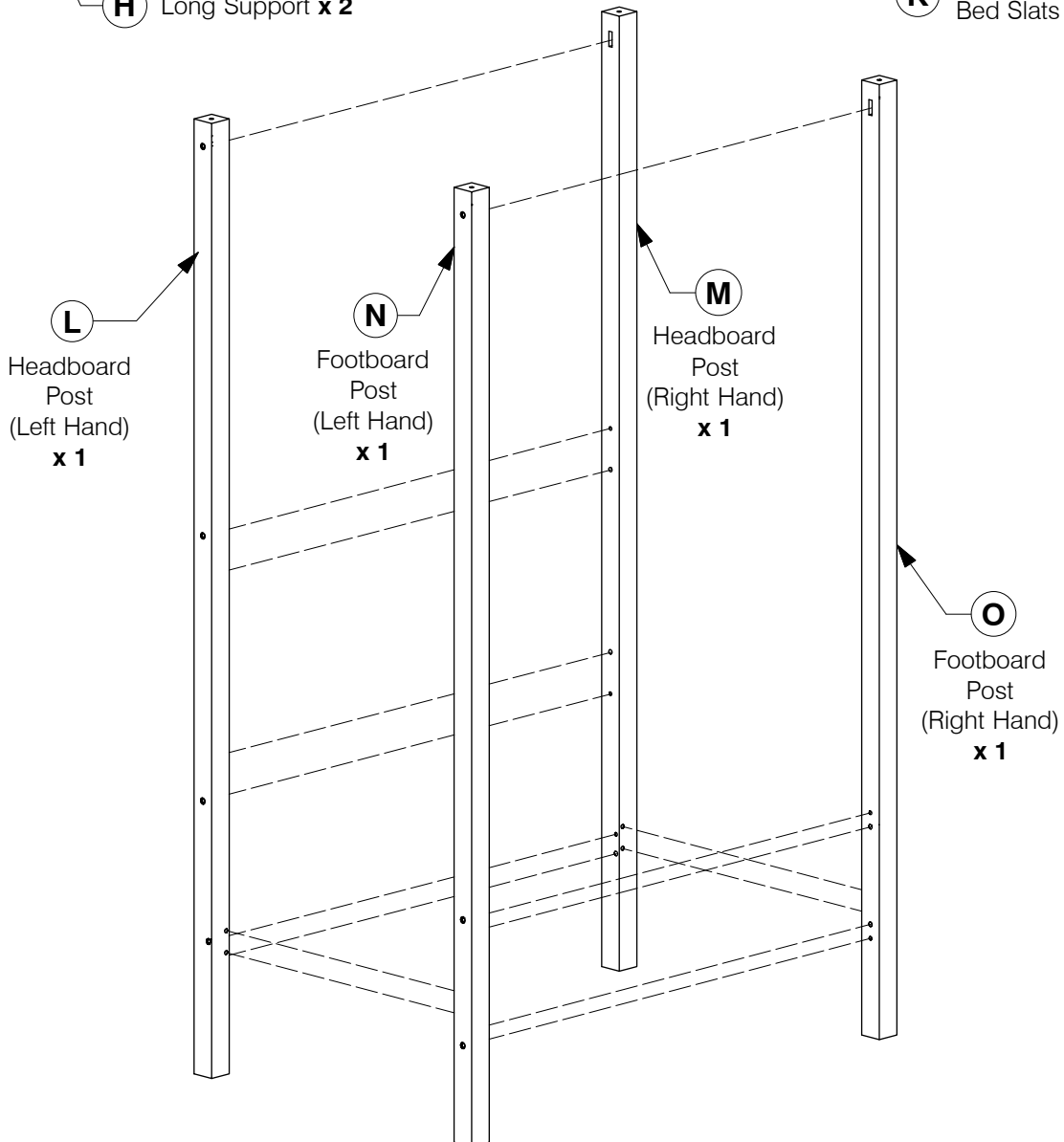
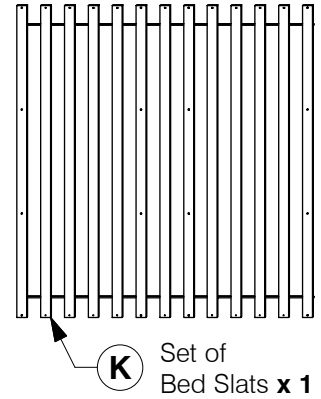
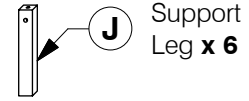
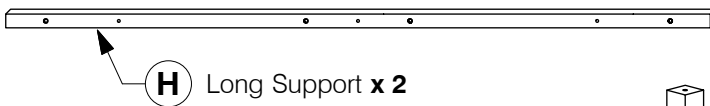
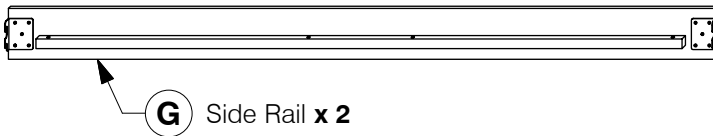
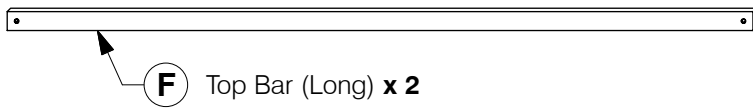
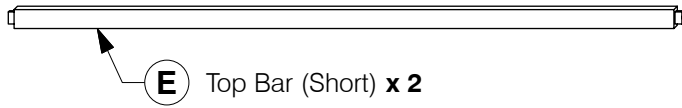

King Bed

Assembly Instructions

3 Hardware List



1 M6 x 100mm JCB
x 14



2 M6 x 90mm JCB
x 6



3 M6 x 50mm JCB
x 4



4 M6 x 40mm JCB
x 16



5 M6 x 30mm JCB
x 4



6 M6 x 20mm JCB
x 8



7 M6 x 15mm JCB
x 8



8 Wood Dowel
(M10 x 40mm) x 10



9 Barrel Nut
x 20



10 Spring Washer
x 8



11 Flat Washer
x 8

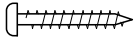

12 Wood Screw
(M4 x 32mm) x 18

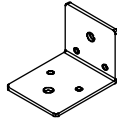

13 Center Rail
Bracket x 4



14 Allen Key
x 1

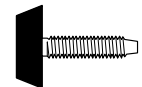

15 Adjustable
Foot x 6

4 Assemble the Support Leg (J) to the Long Support (H).

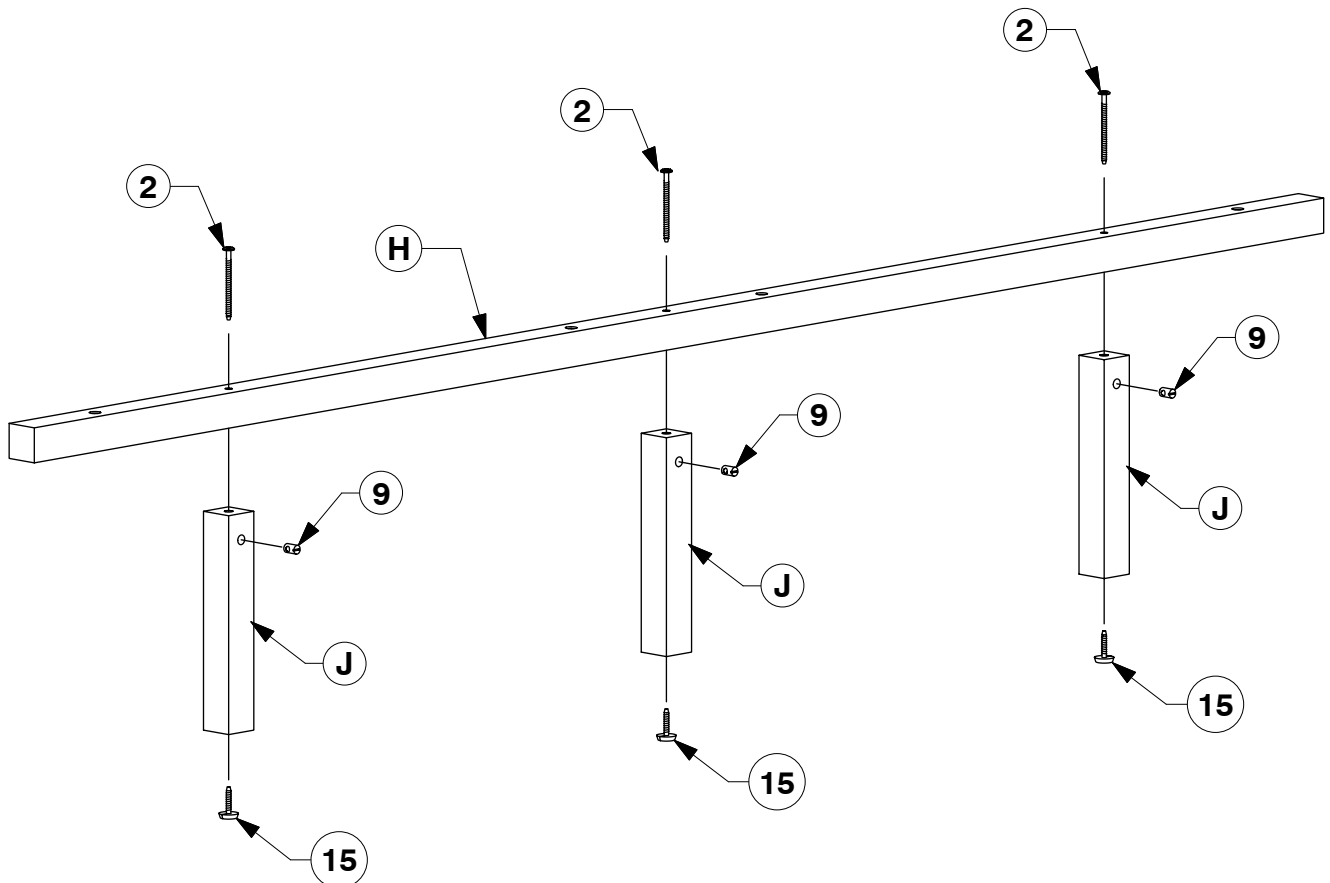

King Bed

Assembly Instructions

- 5** Attach the Headboard Post (L & M) to the Headboard Panel (A), Headboard Support (B) & Top Bar- Short (E). Fit the Center Rail Bracket to the Headboard Support (B).

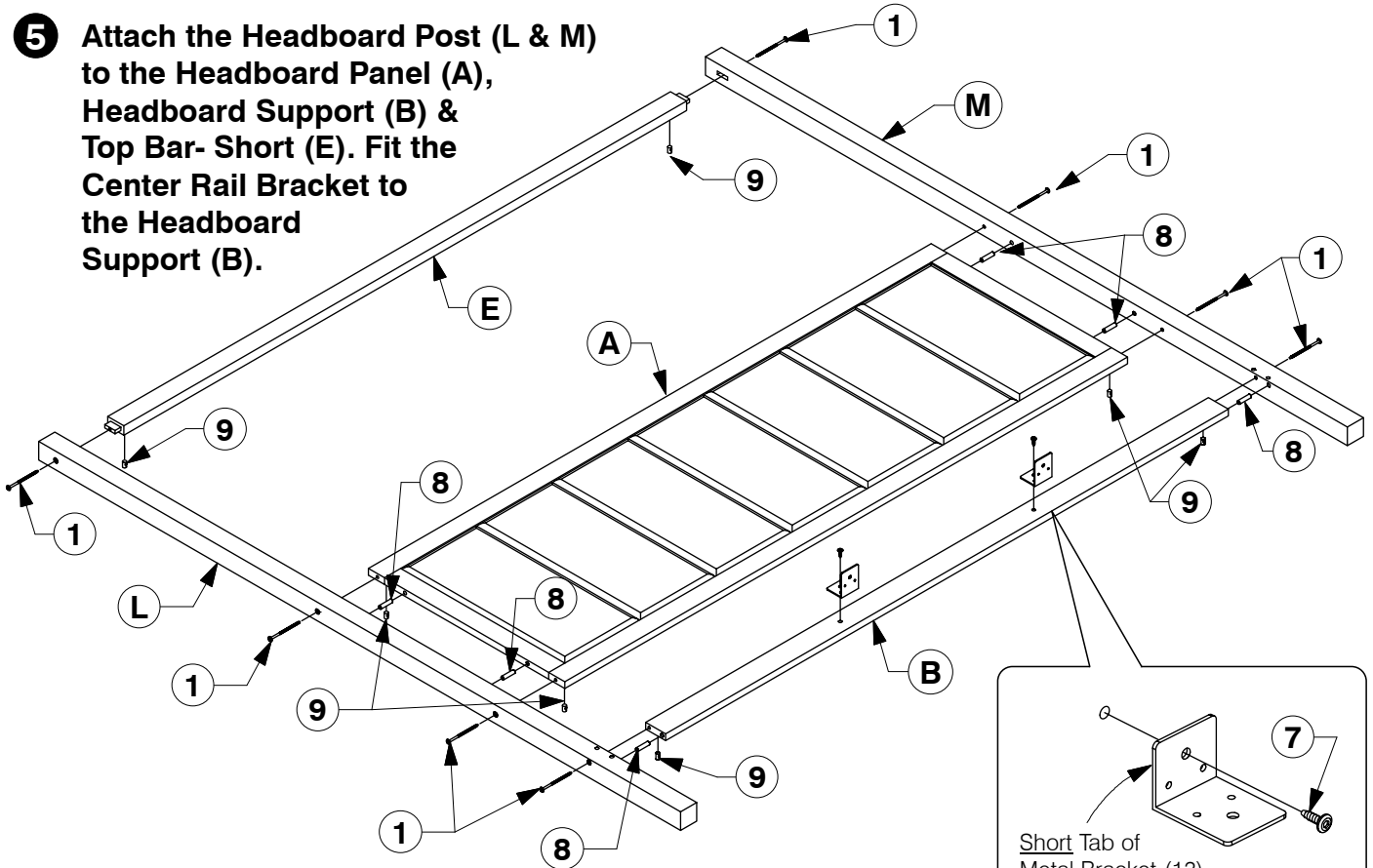

- 6** Attach the Footboard Post (N & O) to the Footboard Panel (C) & Top Bar- Short (E). Fit the Footboard Support Bar (D) & Center Rail Bracket to the Footboard Panel (C).

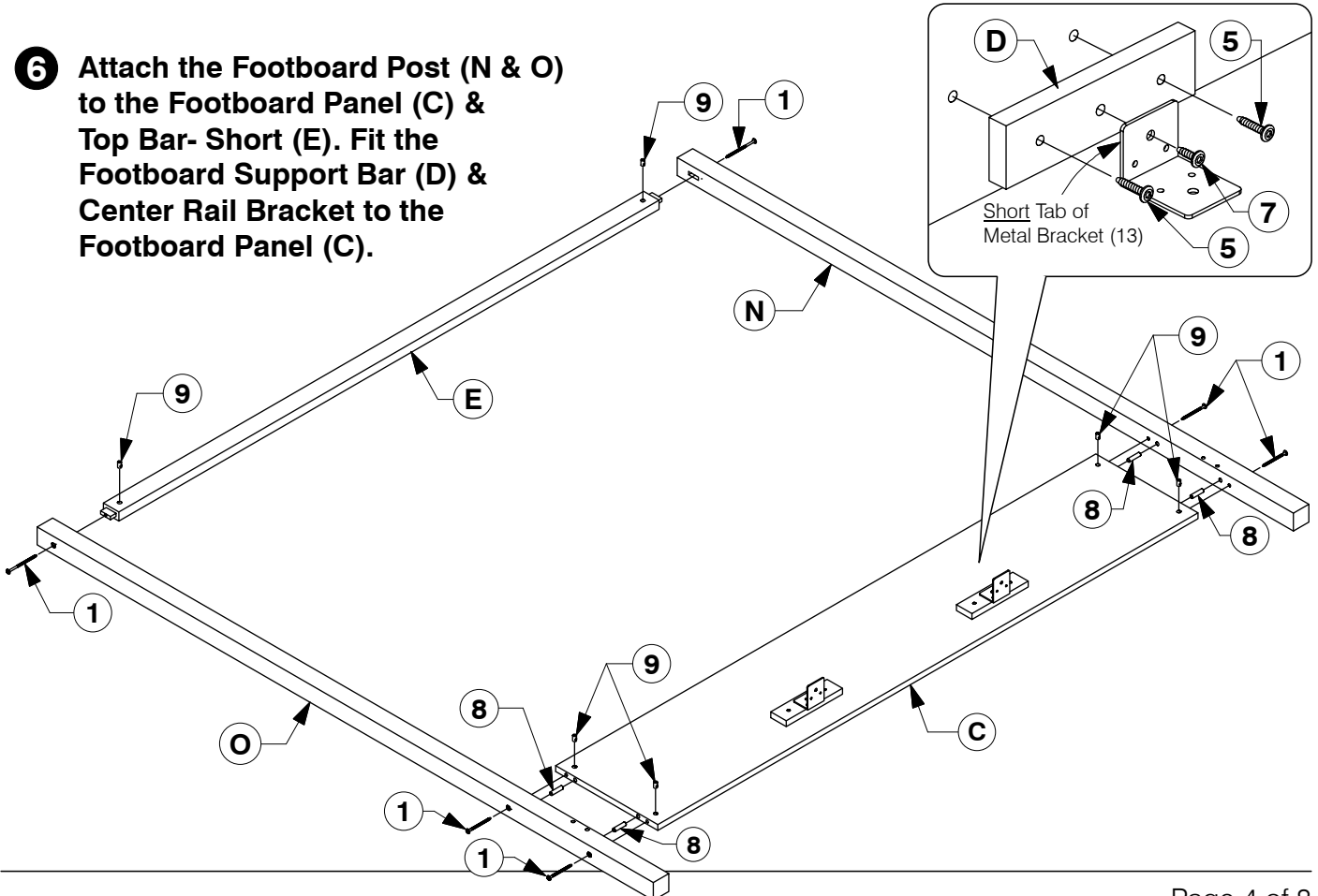

King Bed

Assembly Instructions

7 Assemble the Side Rail (G) to the Head / Footboard.

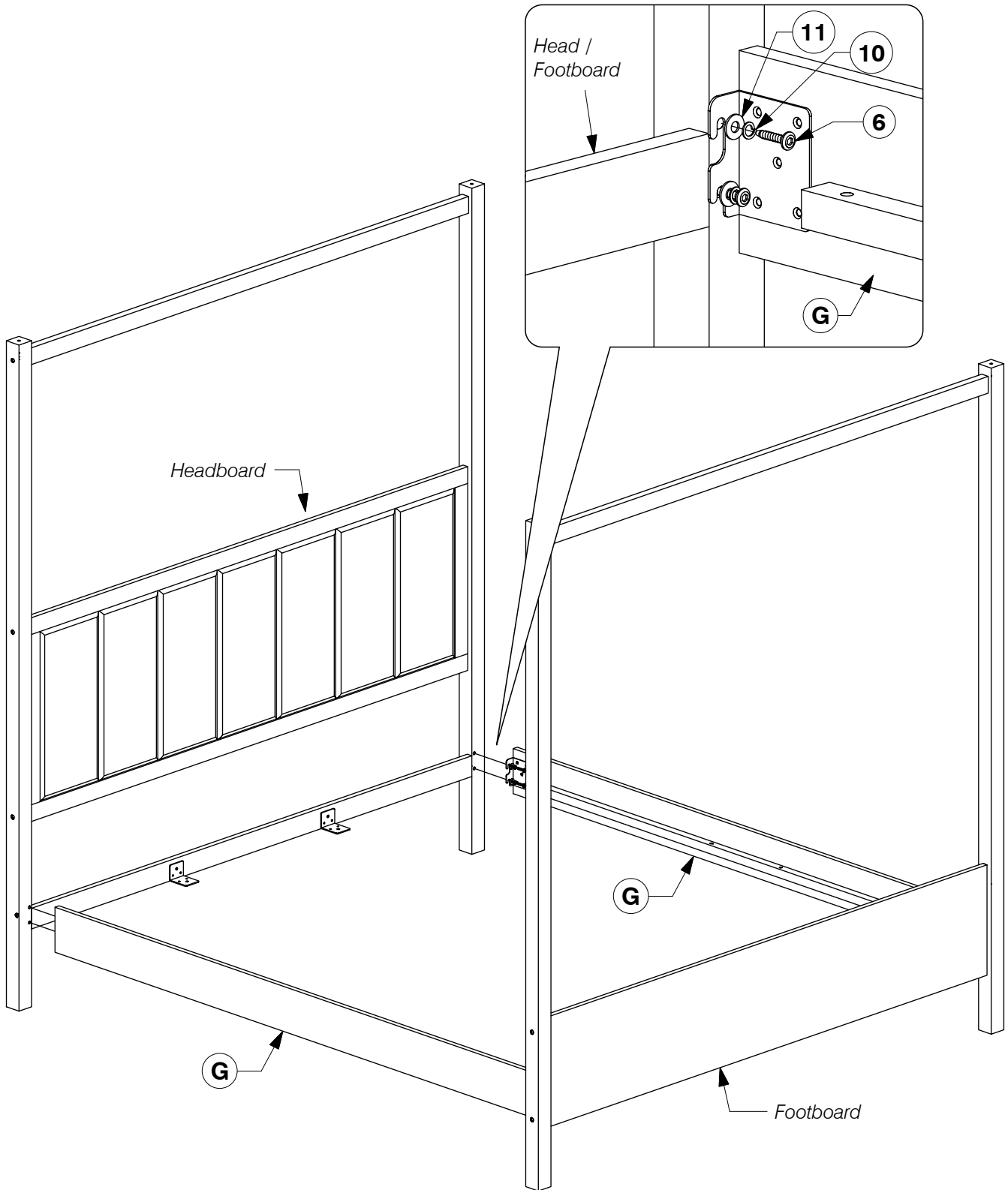

King Bed

Assembly Instructions

- 8** Bolt the Long Support (H) to the Center Rail Brackets on the Head / Footboard.

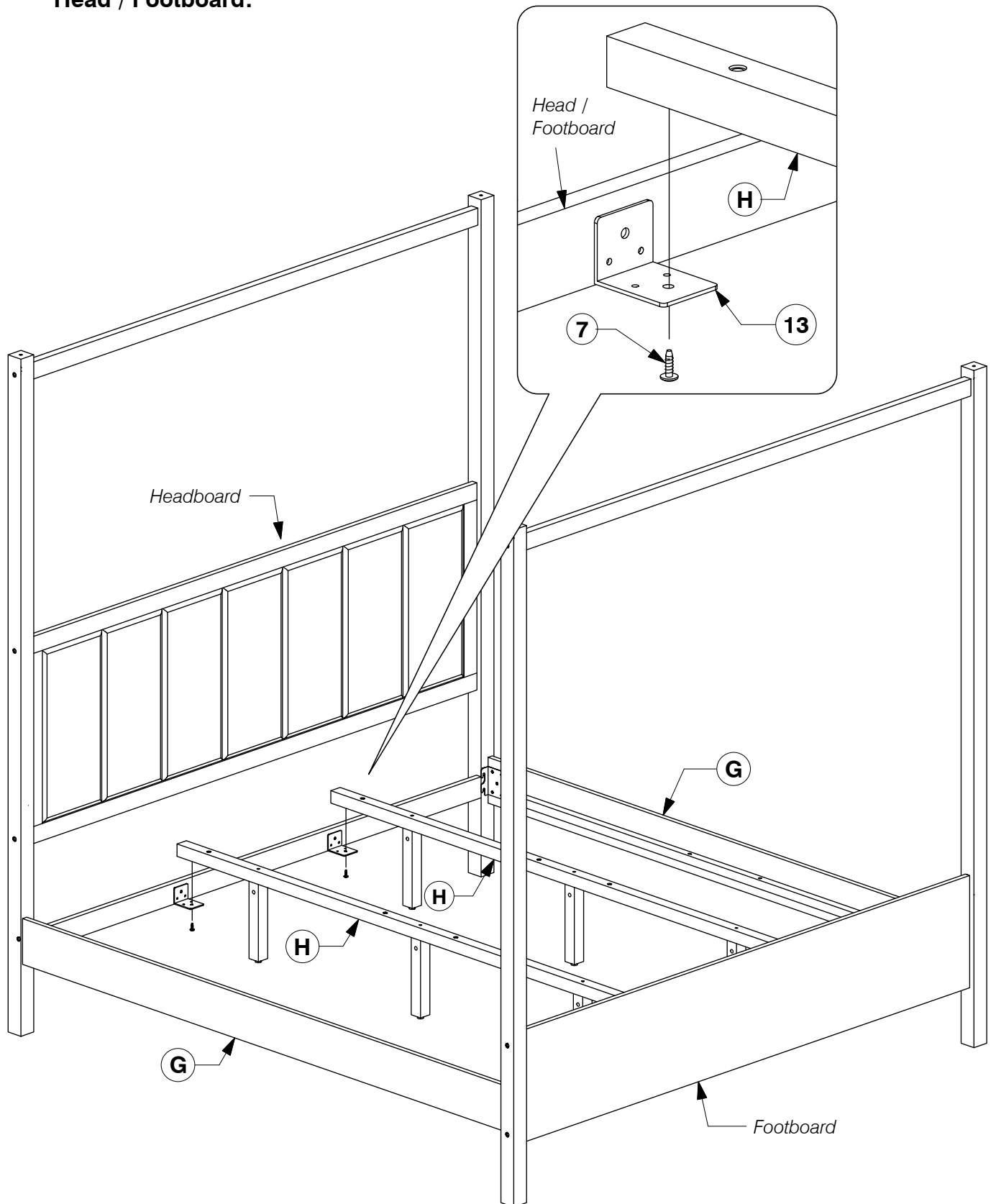

King Bed

Assembly Instructions

- 9** Bolt & screw the Bed Slats (K) to the Side Rail (G).

