

Assembly Instructions

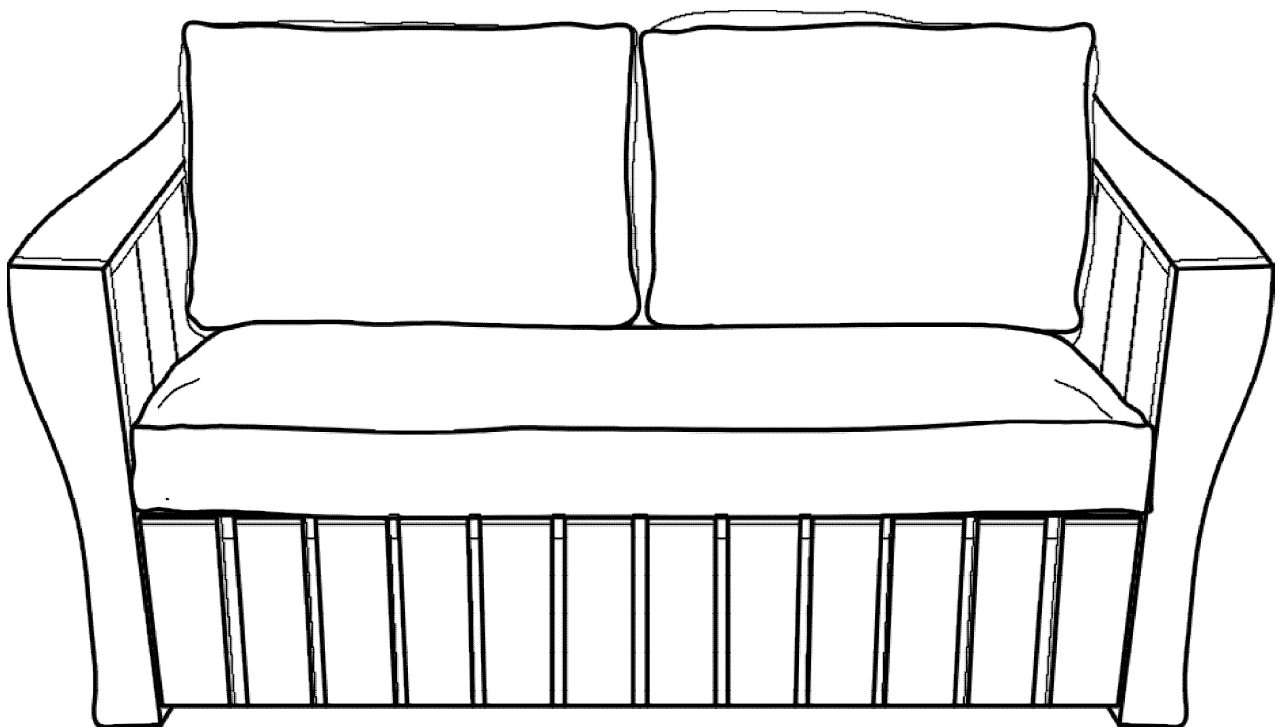

Caution : You must read this before you proceed

LOVESEAT





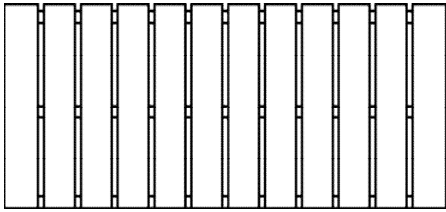
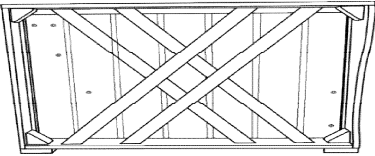
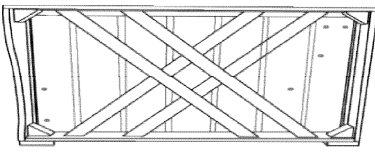
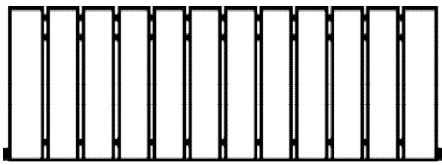
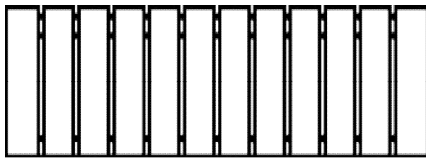
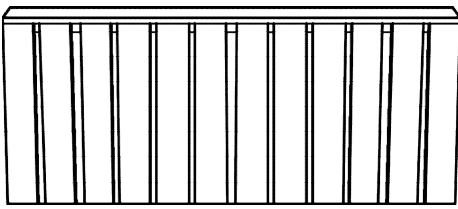
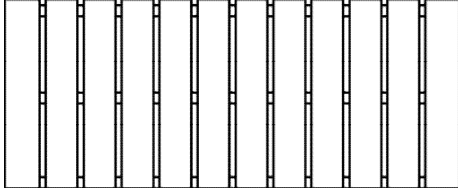

CAUTION : This Loveseat is NOT a TOY.
Keep your child / children at bay during the process of assembly.
When lifting or moving the Loveseat and to prevent damage to the Loveseat, two adults should perform these actions.

Parts List

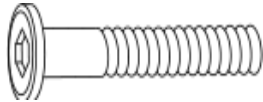
Label	Picture	Description	QTY
A		Seat Panel	1
B1		Right Leg Panel (Labelled B1)	1
B2		Left Leg Panel (Labelled B2)	1
C		Back Panel	1
D		Front Panel	1
E		Backrest Panel	1
F		Bottom Panel	1
G		Backrest Cushion	2
H		Seat Cushion	1

Hardware

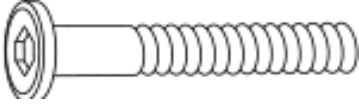
Label	Picture	Description	QTY
①		Short Bolt (M6x20mm)	9
②		Sleeve Nut (M6x13mm)	13
③		Allen key	2
④		Screw (M4x30mm)	3
⑤		Screwdriver	Not provided
⑥		Long Bolt (M6x45mm)	5

Assembly Preparation

Before Beginning Assembly:

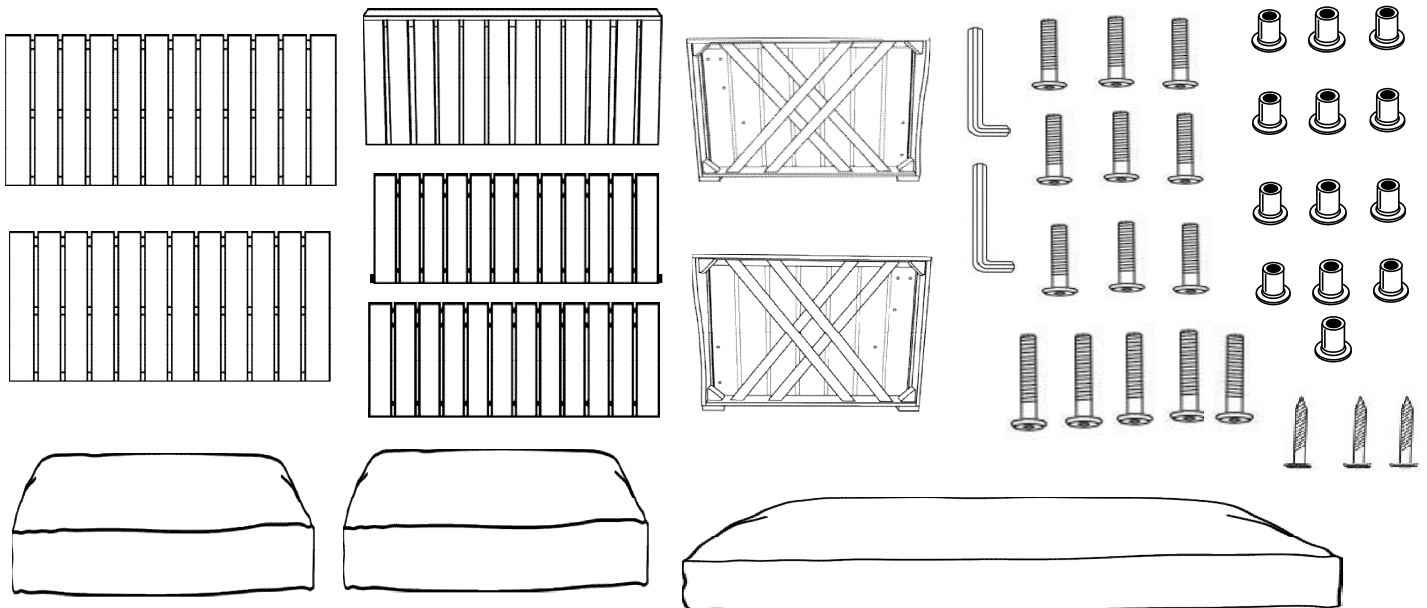

- Read instructions, cover to cover-



- Have 2 adults on hand for assembly-



- Do not assemble on flooring or carpet-



- Assemble on a clean non-marring surface (packing foam)-



- Save all packaging until finished-

Assembly Steps

OVERVIEW

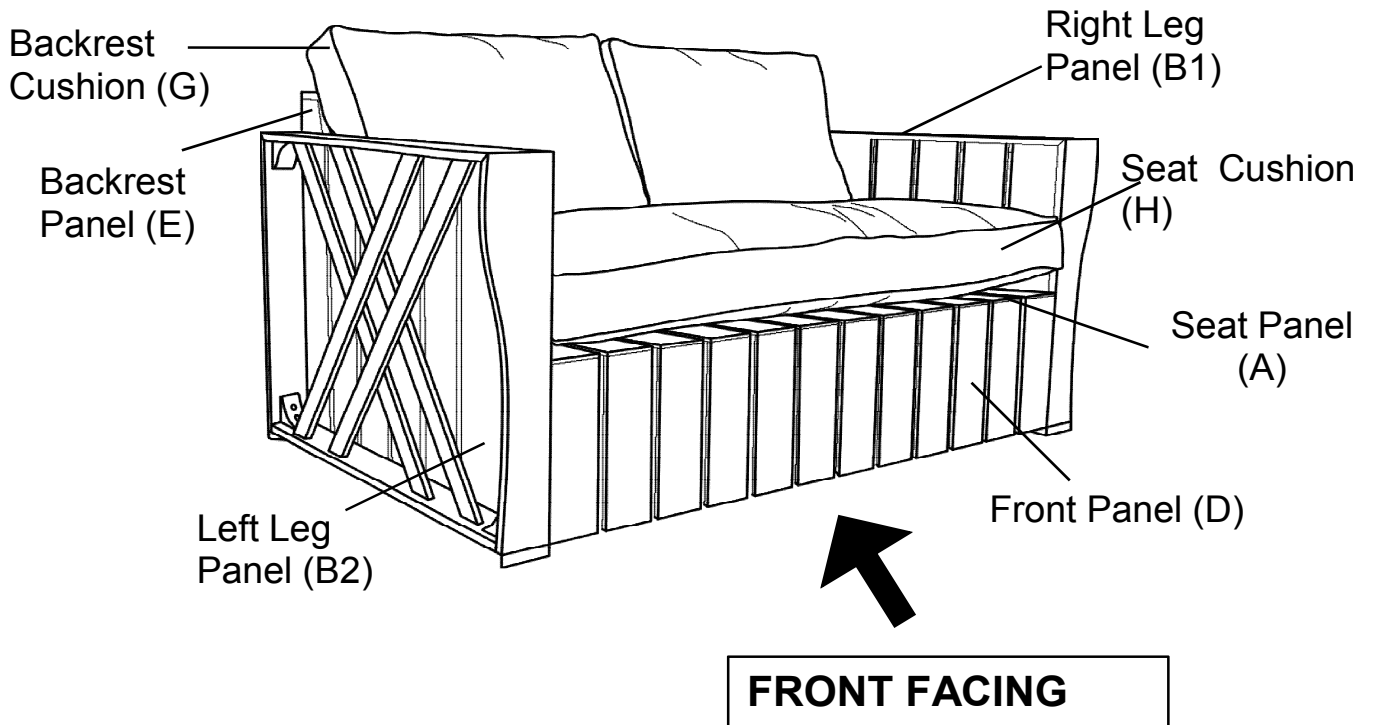

This Loveseat has multiple parts and may require up to some 30 minutes to assemble. To give you an overview of the Loveseat parts, the above picture is to help you put the various parts into perspective. Please read through the instructions below to familiarise yourself with the parts and steps before assembly.

Step 1

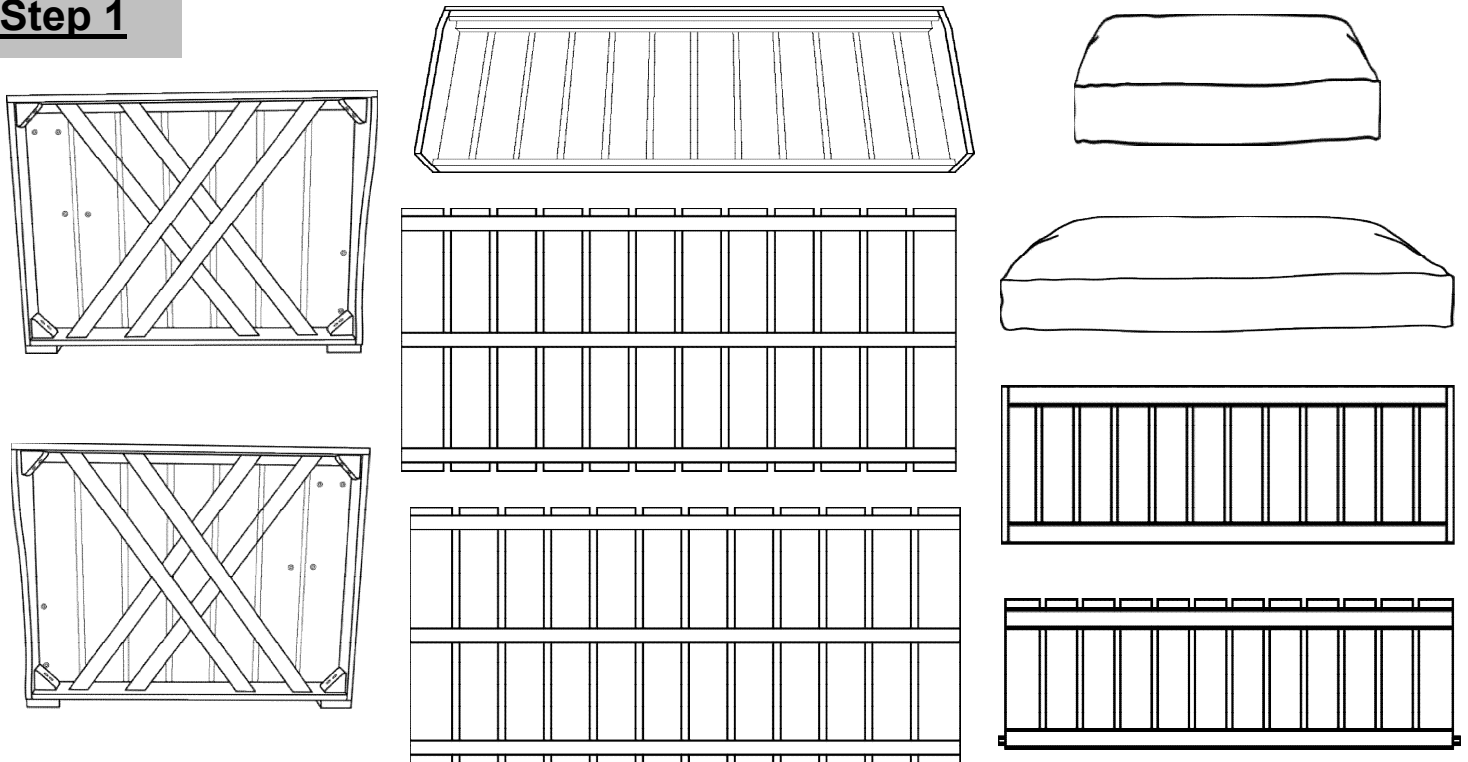

Unpack and place all parts on a clean, non-marring surface.

Step 2

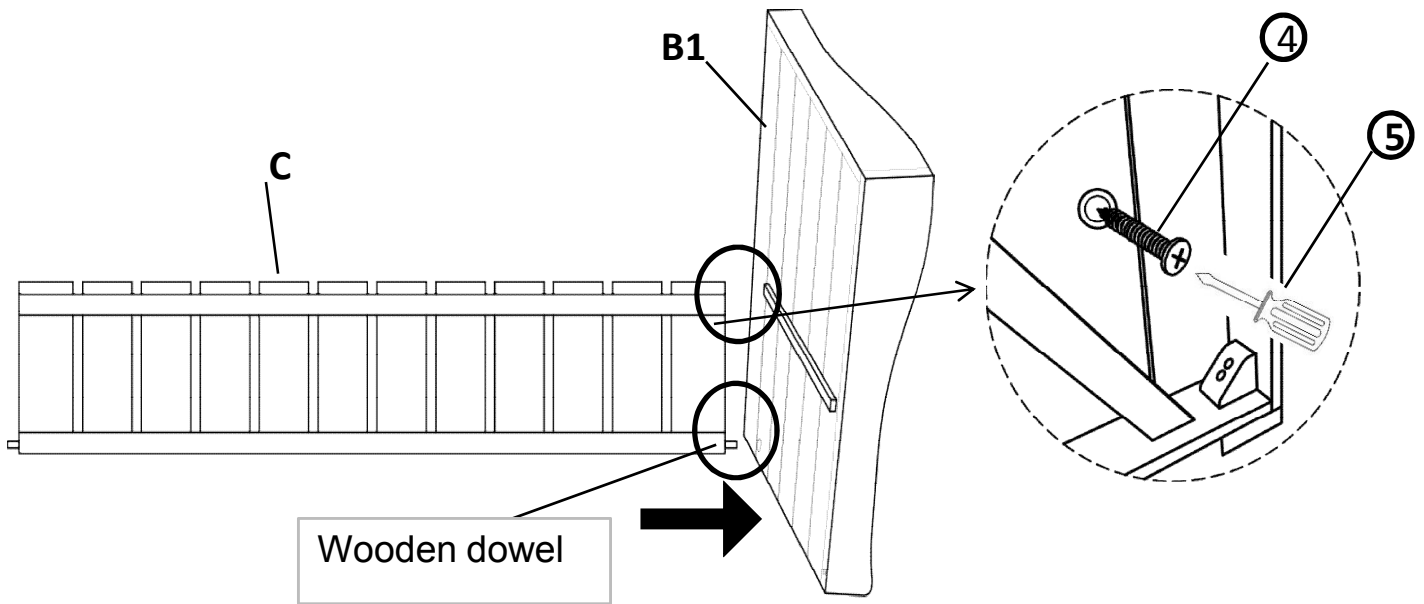

Insert the wooden dowel on Back Panel(C) into mounting position on Right Leg Panel(B1).

Affix Back Panel(C) with Right Leg Panel(B1) using Screw(④), with Screwdriver (⑤)

Only loosely tighten the Screws.

Step 3

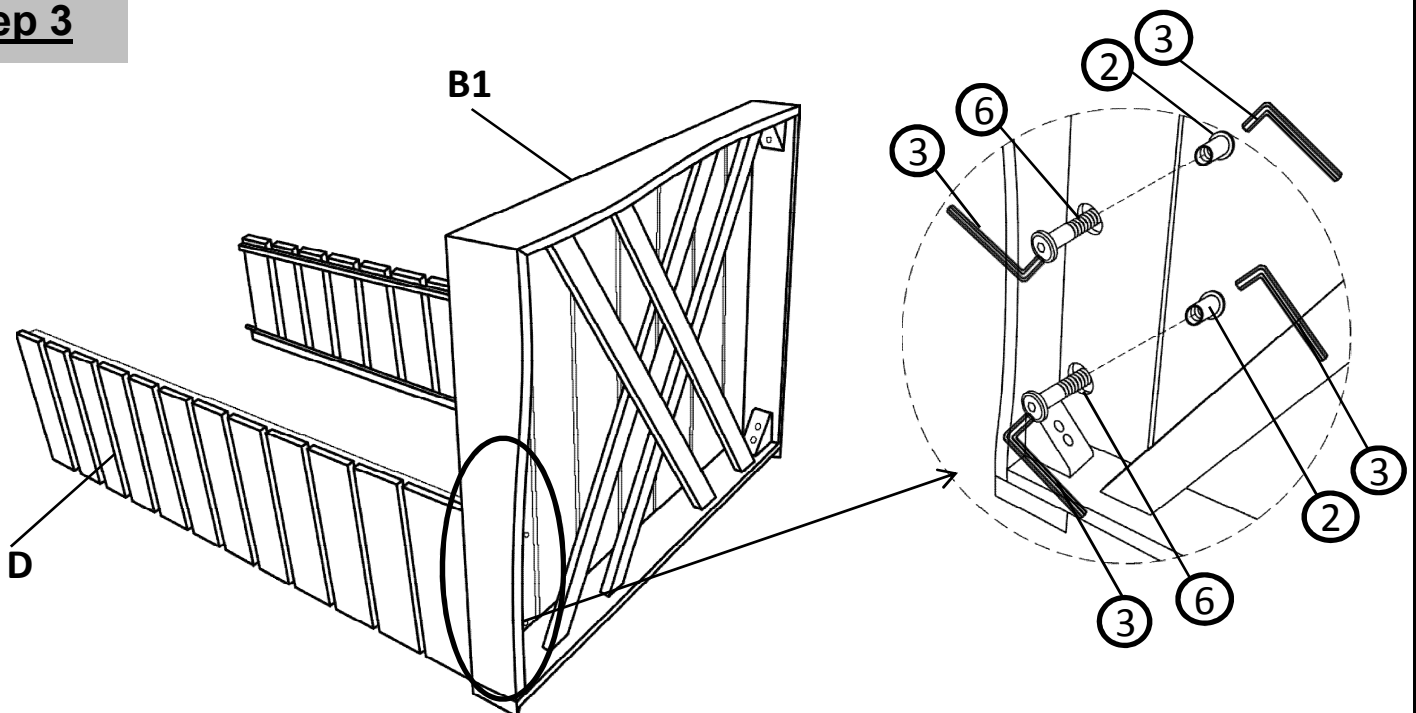

Attach Front Panel(D) to Right Leg Panel(B1) using Long Bolt(⑥) and Sleeve Nut(②) with Allen Keys(③)

Only loosely tighten the Bolts.

Repeat the same process of **Step 2 and 3** with the other Left Leg Panel(B2).

Step 4

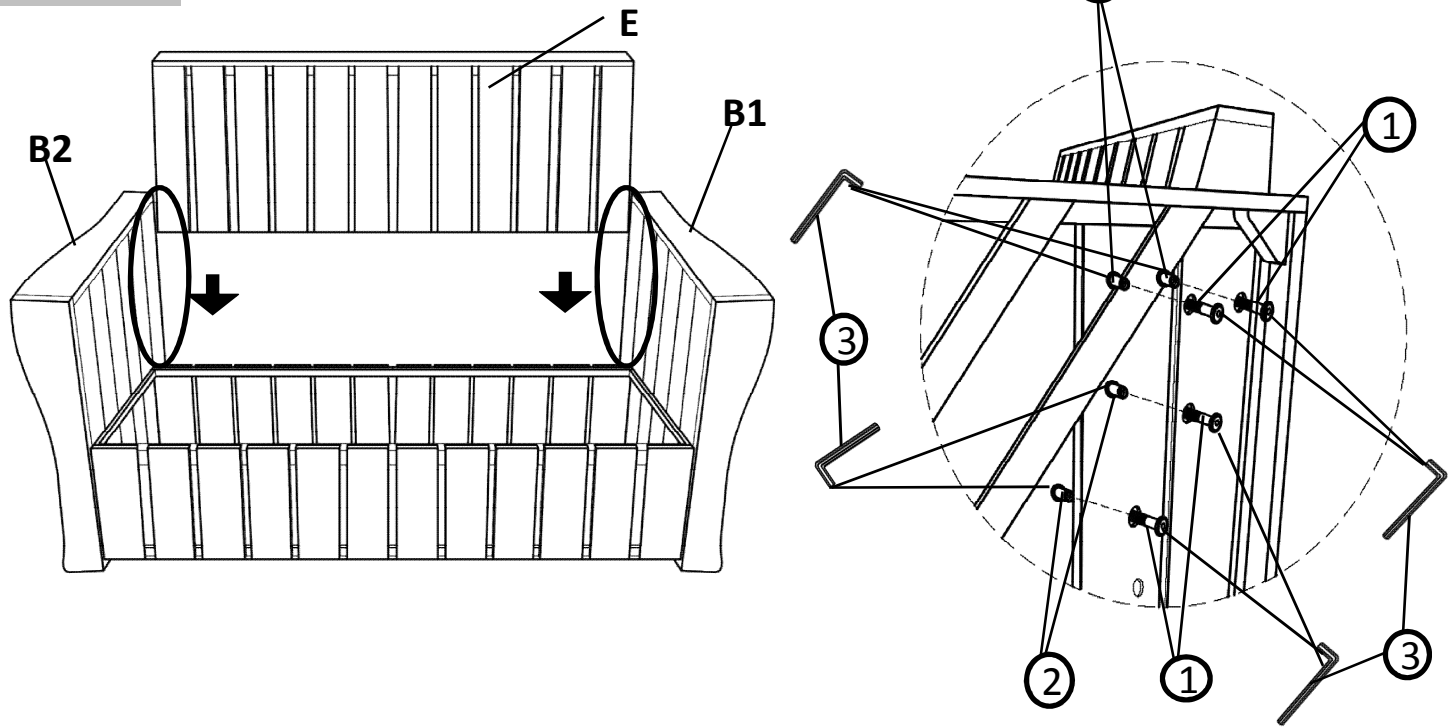

Then, attach Backrest Panel(E) to Right Leg Panel(B1) and Left Leg Panel(B2) using Short Bolt(①) and Sleeve Nut(②) with Allen Keys(③)
Only loosely tighten the Bolts.

Step 5

Step 5.1

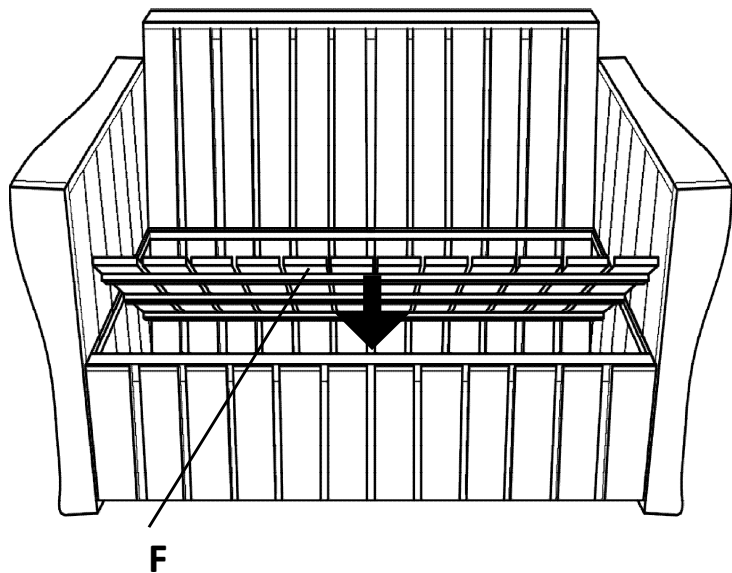

Step 5.2

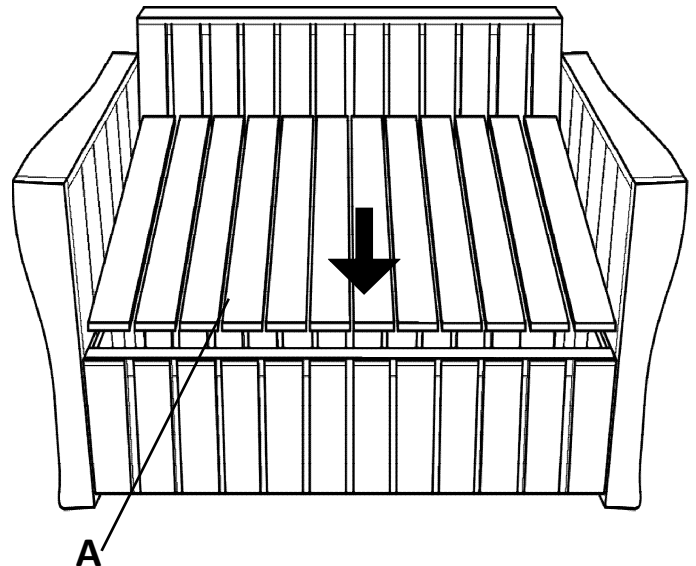

5.1: Position Bottom Panel(F) into inside of the Loveseat. This can make the Loveseat have storage function

5.2: Position Seat Panel(A) onto the Loveseat. Seat Panel (A) should be inside of Front Panel (D)

Step 6

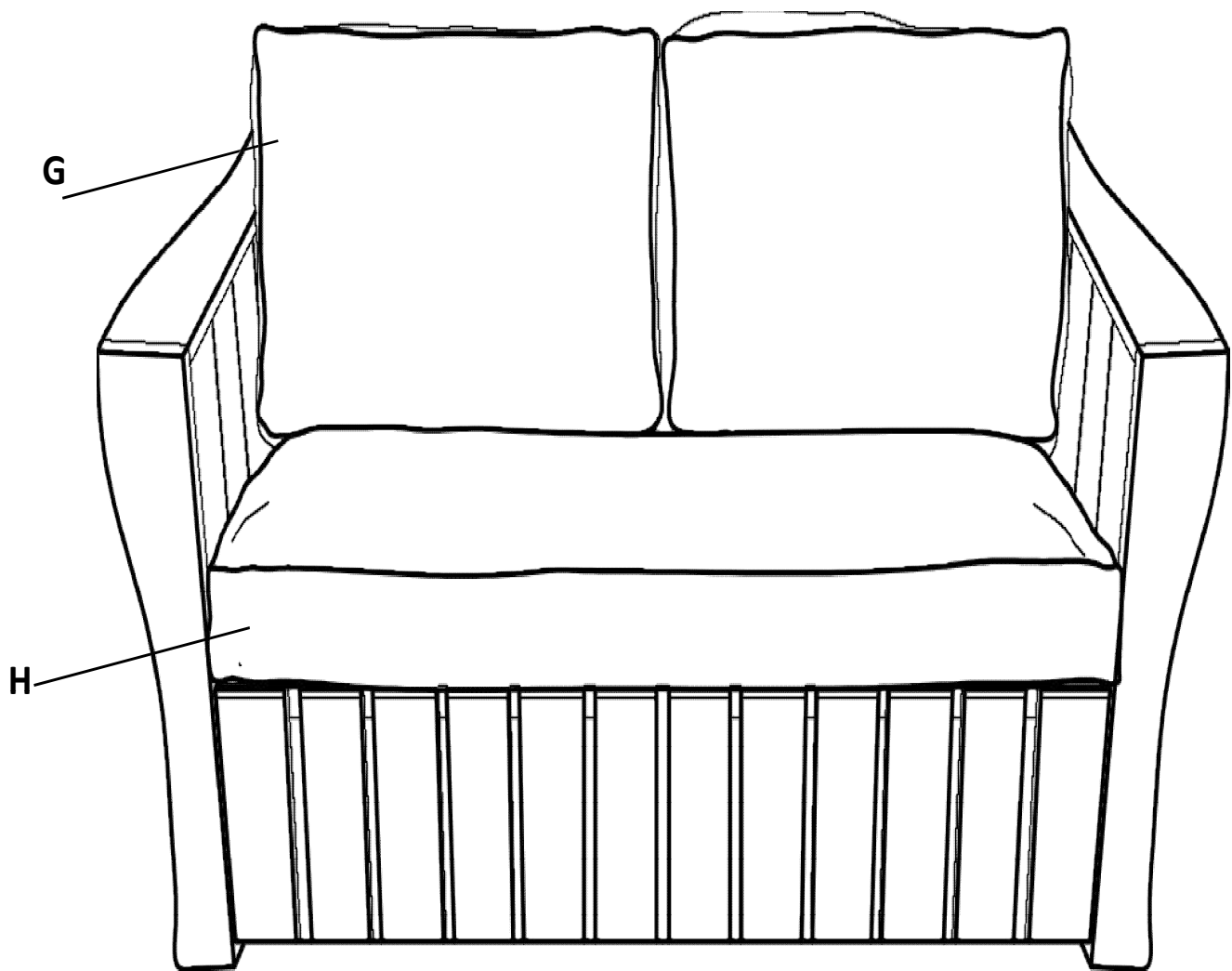

Place the Loveseat on a LEVEL SURFACE

Inspect it and make sure all parts are adequately connected.

Gently, sit into to the Loveseat. This would help to align all parts at all joints.



















Then get off the Loveseat, and in a sequential manner, proceed to tighten all Bolts and Screws.

Place Backrest Cushion(G) and Seat Cushion(H) onto the Loveseat.

Your Loveseat is ready for use.

This Loveseat can only be used on a flat, level surface.

Care & Maintenance

-   ● Do not put hot items directly on furniture surface
 -   ● Do not clean furniture with harsh cleansers or polish.
 -   ● To obtain the longest lifespan of your outdoor products, minimizing exposure to direct sunlight is recommended.
 -   ● Children should not climb or jump on the furniture.
 -   ● Do not write on furniture without a padded barrier to protect the surface.
 -   ● To obtain the longest lifespan of your outdoor products, avoid extended and lengthy exposure to rain, snow, and direct sunshine. Whenever possible cover the product and /or place under patio or awnings.
 -   ● Not for commercial use. For residential use only .
 -   ● Stains may be removed with mild soap solution and damp cloth.
-
-   ● Dust and pick-up spills using a clean, non-colored, lint-free cloth .

Questions & Answers about Proposition 65

• What is Proposition 65?

Proposition 65 requires businesses to provide warnings to Californians about significant exposures to chemicals that cause cancer, birth defects or other reproductive harm.

These chemicals can be in the products that Californians purchase, in their homes or workplaces, or that are released into the environment. By requiring that this information be provided, Proposition 65 enables Californians to make informed decisions about their exposures to these chemicals.

Proposition 65 also prohibits California businesses from knowingly discharging significant amounts of listed chemicals into sources of drinking water.

Proposition 65 requires California to publish a list of chemicals known to cause cancer, birth defects or other reproductive harm. This list, which must be updated at least once a year, has grown to include approximately 900 chemicals since it was first published in 1987.

• What types of chemicals are on the Proposition 65 list?

The list contains a wide range of naturally occurring and synthetic chemicals that include additives or ingredients in pesticides, common household products, food, drugs, dyes, or solvents. Listed chemicals may also be used in manufacturing and construction, or they may be byproducts of chemical processes, such as motor vehicle exhaust.

• What does a warning mean?

If a warning is placed on a product label or posted or distributed at a workplace, a business, or in rental housing, the business issuing the warning is aware or believes that it is exposing individuals to one or more listed chemicals.

By law, a warning must be given for listed chemicals unless the exposure is low enough to pose no significant risk of cancer or is significantly below levels observed to cause birth defects or other reproductive harm.

• Where can I get more information on Proposition 65?

If you have specific questions on the administration or implementation of Proposition 65, you can contact OEHH's Proposition 65 program at P65.Questions@oehha.ca.gov, or by phone at (916) 445-6900.