

Top View

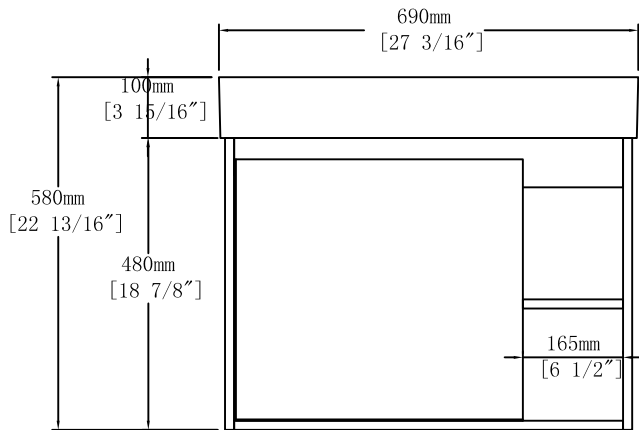

Front View

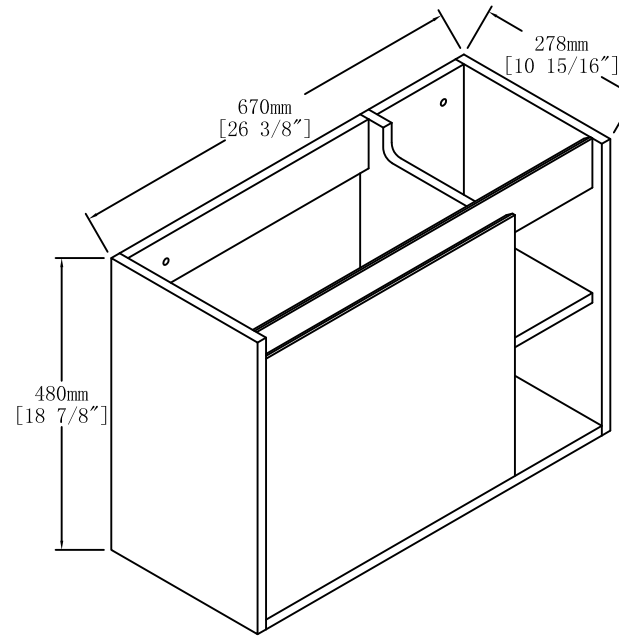
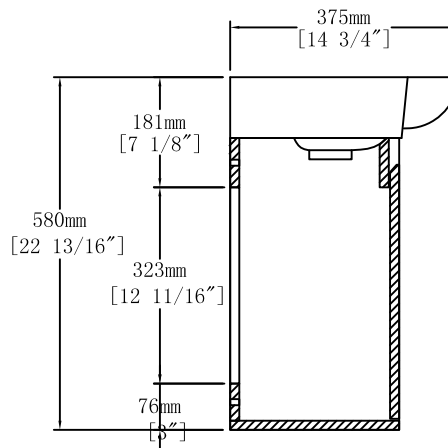

Side View

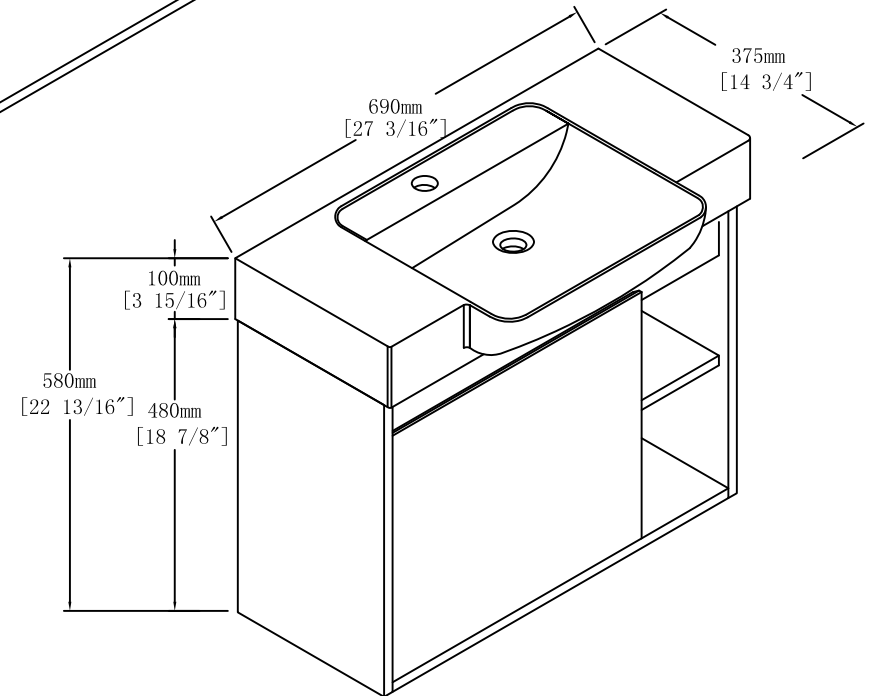

	Item NO.		Version	V1
	Project		Date	2024-11-30