























READ AND SAVE THIS INSTRUCTION FOR FUTURE USE

ASSEMBLY INSTRUCTION

NO.	COMPONENT	QTY
A		4
A1		4
B		4
B1		4
C		8
C1		8
D		8
D1		4
E		4
E1		4
E2		4
F		4
F1		4

NO.	COMPONENT	QTY
G		4
H		4
I		1
J	 M6x30	16
K	 M6x45	16
L		32
M	 M6	32
N		8
O	 M6	2
P		1
Q		4

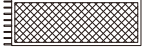
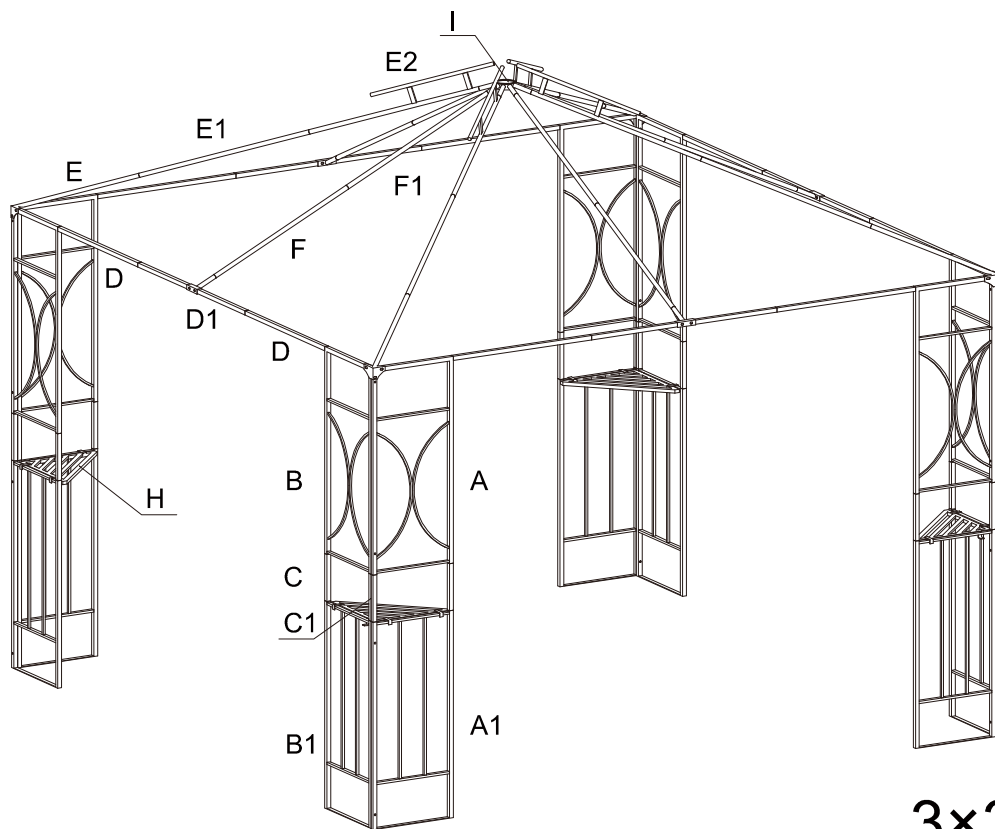

3×3×2.7M



K x12



L x12



M x12

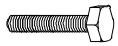
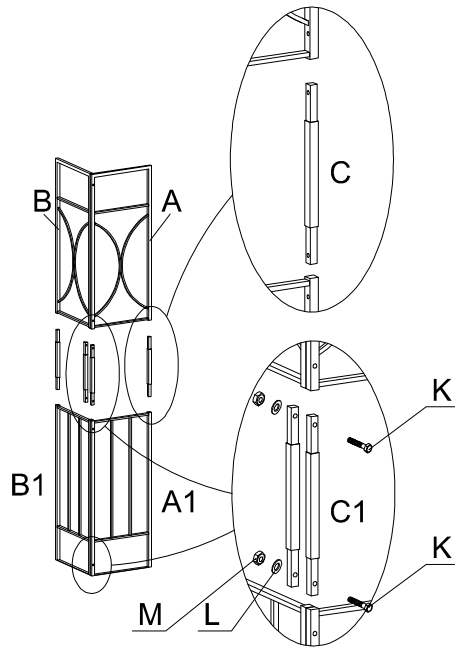

J x8



L x8



M x8

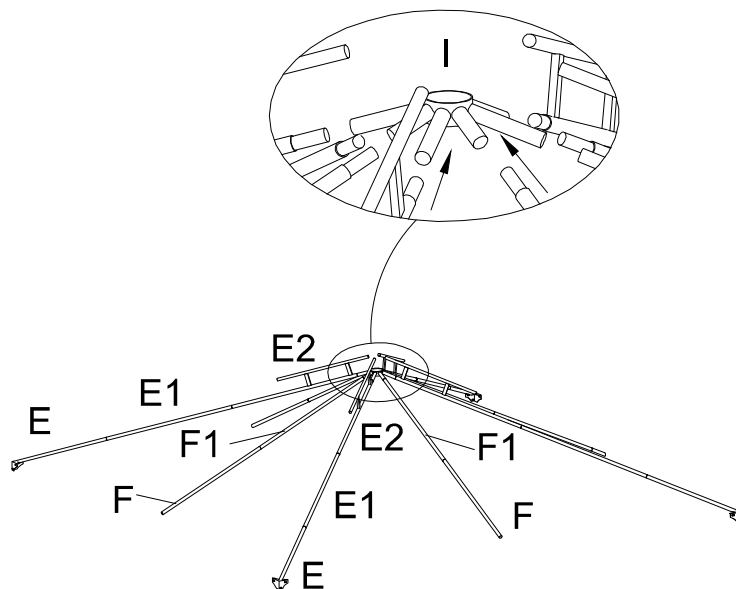
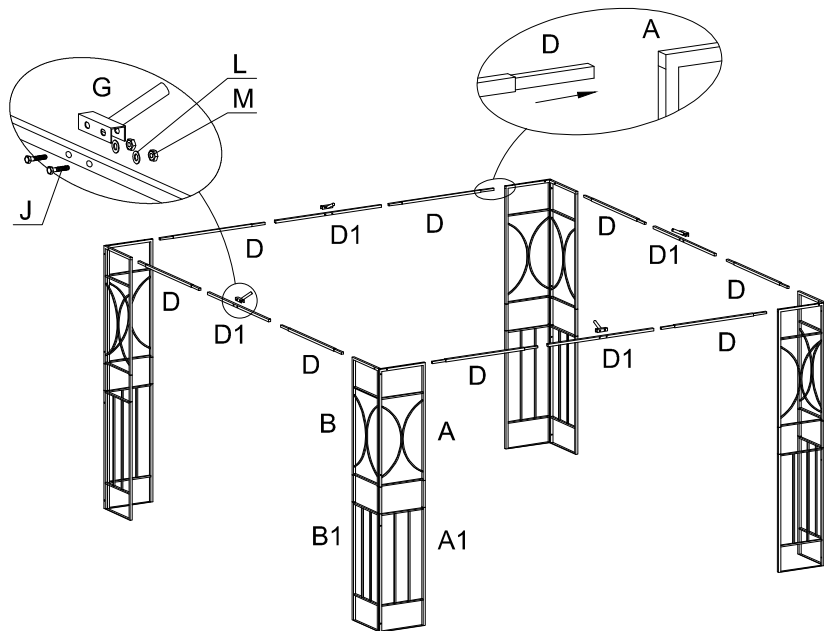



J x8

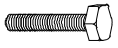

K x4



L x12



M x12

