

Assembly Instruction

Tools Required: Flathead screwdriver, Phillips screwdriver, pliers, wire cutters, wire strippers, electrical tape, safety glasses.

Light Source: (1) G9 Xenon Clear bulb (supplied), 60W Maximum

Estimated Assembly Time: 30-45 minutes

Preparation: Identify and inspect all parts before beginning installation. Check package content list and diagrams below to be sure all parts are present. If any parts are missing or damaged, do not attempt to assemble, install, or operate the fixture. Contact customer service for replacement parts.

⚠ Warnings and Cautions

Turn off electricity at circuit breaker or main fuse box before installation. Consult a licensed electrician if in doubt.

These instructions are provided for your safety. It is very important you read them completely before installing the fixture. We strongly recommend that a licensed, professional electrician perform the installation.

Disconnect fixture from power source before replacing bulbs. Make sure bulbs are given sufficient time to cool before removal. Do not subject glass parts to any shock while in operation or shattering may result.

Do not touch the bulb with bare hands use a cloth or glove.

Package Contents

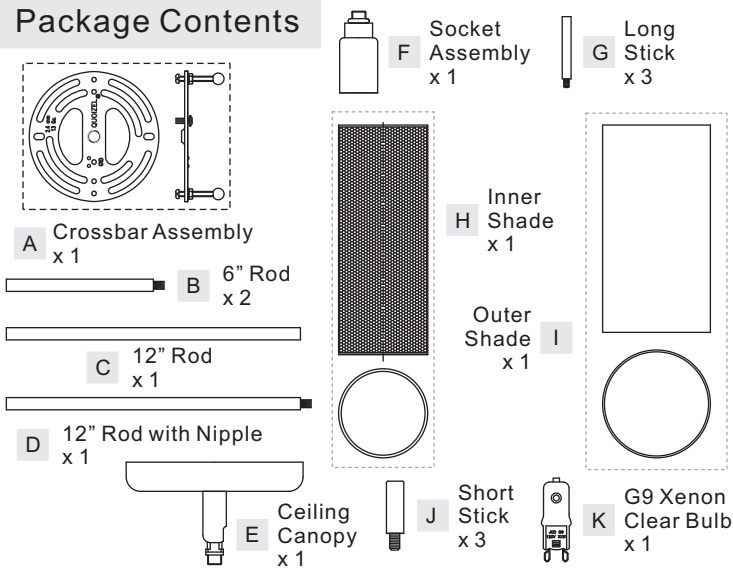

STEP 1 - Install Bulbs and Shade

- This fixture uses G9 Xenon clear bulb (K). Maximum 60 watts. Insert bulb and push snugly into place.
- Place Inner Shade (H) over the Socket Assembly (F), line up the hole on the Inner Shade (H) and the mounting hole on the Socket Assembly. Threading Long Stick (G) into the mounting hole, tighten until snug.
- Place Outer Shade (I) over the Inner Shade (H), line up the hole on the Outer Shade (I) and the mounting hole on the Long Stick (G). Threading Short Stick (J) into the Long Stick (G), hand tighten until snug.

IMPORTANT: Do not touch the bulb with bare hands use a cloth or glove.

Figure 1

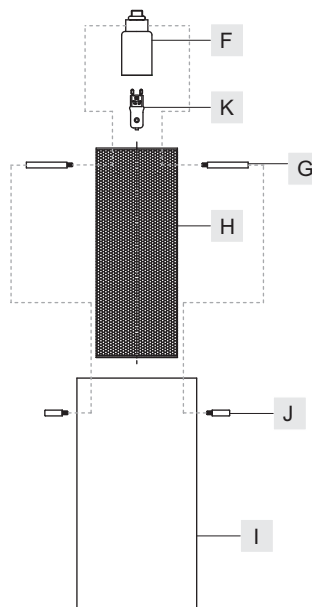

STEP 2 - Install Ceiling Canopy, Rods and Socket Assembly together

- Determine the Rods (B/C/D) to be assembled to the Socket Assembly with Shades according to your hanging height.
- Pass the supply wires and ground wire through the chosen rods (B/C/D) and the Ceiling Canopy (E). Thread the Socket Assembly with Shades, the chosen Rods (B/C/D) and the Ceiling Canopy (E) together. Hand tighten until snug.

Suggested rods for Ceiling height:
 8' ceiling : use (2) 12" rods
 9' ceiling : use (2) 6" rods and (2) 12" rods

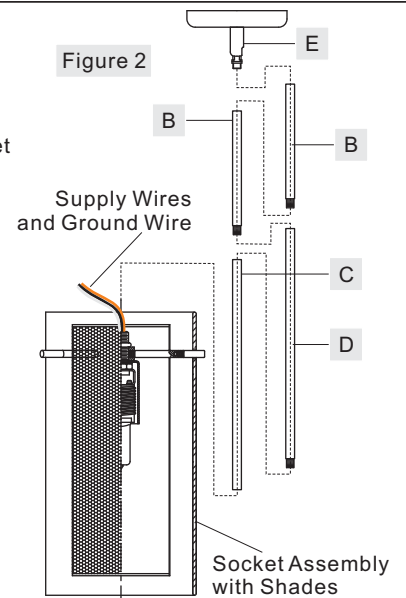

STEP 3 - Install Crossbar Assembly

- Pass the supply wires through the Crossbar Assembly (A). Attach the Crossbar Assembly (A) to the Outlet Box with the head of the Green Ground Screw facing you. Secure it with Outlet Box Screws (not included). Tighten until snug.

Figure 3

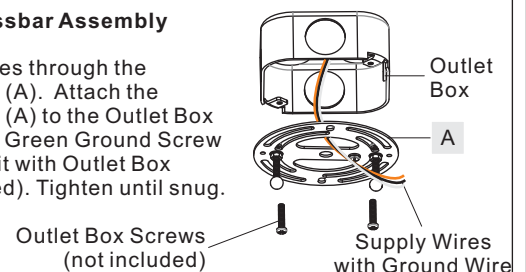

STEP 4 - Fit Ceiling Canopy to Crossbar Assembly

- Remove mounting balls from the Crossbar Assembly (A). Fit the Ceiling Canopy (E) to the Crossbar Assembly (A) and secure with mounting balls. Note: The Ceiling Canopy (E) should be snug against the ceiling and the mounting balls. If not, adjust the length of the nipple on the Crossbar Assembly (A) by unscrewing the preassembled hex nut and lock washer and then screwing the mounting screws in or out of the

Figure 3

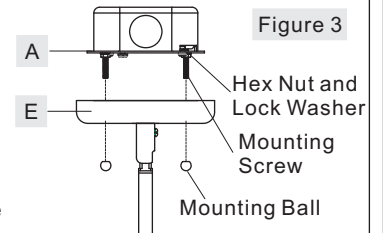

crossbar until the correct length is achieved. Once the Ceiling Canopy (E) is secure, remove the mounting ball and Ceiling Canopy (E) and proceed to Step 5.

STEP 5 - Wire Connections

A. Use standard wire connectors (not included) to make all wire connections. (Connectors are not included with fixture.) Twist connectors until wires are tightly joined together. Wrap each connection with approved electrical tape and carefully stuff all the connected wires into the Outlet Box.

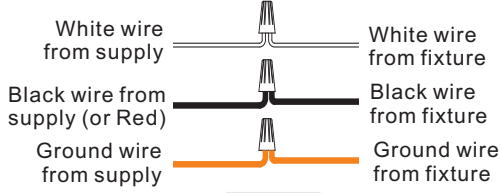

Figure 5

STEP 6 - Install Fixture Body

A. Carefully tuck all wires into the outlet box and position the Ceiling Canopy (E) over the outlet box. Align the holes in the Ceiling Canopy (E) with the mounting screws, then attach the Ceiling Canopy (E) using the previously removed mounting balls. Hand tighten until snug.

Your fixture is now assembled and ready to use. Enjoy!

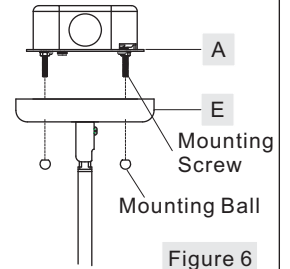
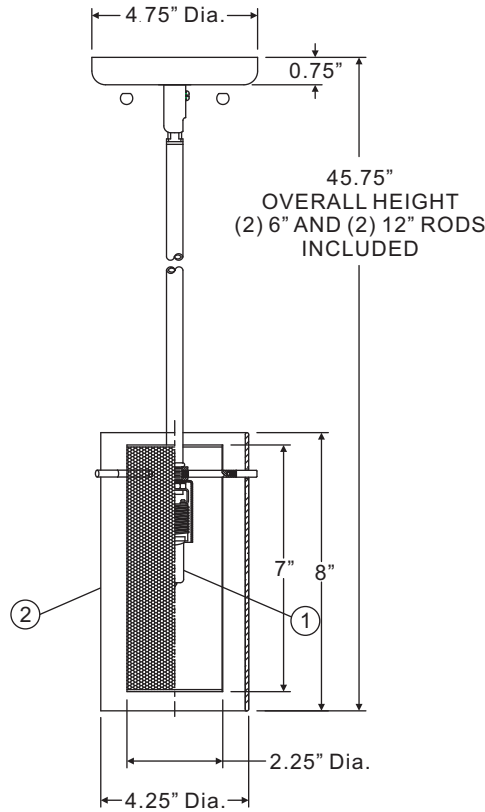
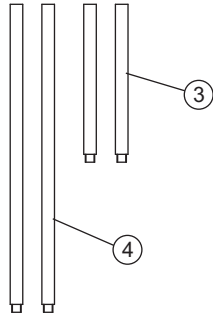
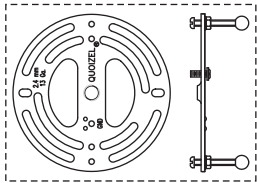

Figure 6

CAUTION FOR BULB REPLACING

- A. When replace bulb, turn off power and allow bulb to cool. For safety purpose, wear gloves and eye protection.
- B. If bulb is scratched or cracked, DO NOT use the bulb to avoid breakage during use or installation.
- C. Use only in fixtures rated for lamps wattage and voltage.
- D. Lamp operate under high pressure generating intense heat. Prevent contact with liquid and combustible materials.

FINISH: BRUSHED NICKEL



NOTE: ALL DIMENSIONS ARE ROUNDED UP TO THE NEAREST 1/4"

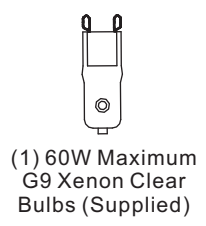

NO.	PART NUMBER	REPLACEMENT	REQ.
1		G9 CLEAR XENON BULB	1
2		GLASS SHADE	1
3		6"L ROD	2
4		12"L ROD	2