

ASSEMBLY INSTRUCTION

LSF2-SEATER







RSF CHAISE





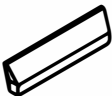



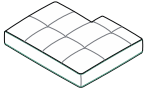
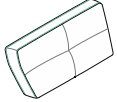
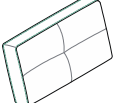
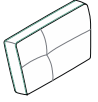

Legs and hardware are stored in the inner box, please take out the legs and hardware for assembly.

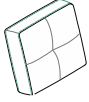











NOTE: Do not use power tools for assembly. Power tools increase the risk of over tightening which lead to spliting or cracking the wood

Component list













NO.	DRAWING	QTY	DESCRIPTION
A		1	LSF 2-SEATER SEAT FRAME
B		1	RSF-CHAISE BACK REST
C		1	LSF 2-SEATER ARM REST
D		1	LSF 2-SEATER BACKREST
E		1	RSF-CHAISE ARM REST
F		1	RSF CHAISE BACKREST
G		2	LSF 2-SEATER LSF/RSF SEAT CUSHION
H		1	RSF-CHAISE REAR SEAT CUSHION

NO.	DRAWING	QTY	DESCRIPTION
I		1	RSF-CHAISE FRONT SEAT CUSHION
J		1	LSF 2-SEATER LSF BACK CUSHION
K		1	LSF 2-SEATER RSF BACK CUSHION
L		1	LSF 2-SEATER FRONT BACK CUSHION
M		1	RSF-CHAISE MIDDLE BACK CUSHION
N		1	RSF-CHAISE REAR BACK CUSHION
O		1	RSF-CHAISE FRONT BACK CUSHION
P		8	PLASTIC LEG
Q		10	LONG BOLT φ1/4" X 3-1/2"
R		10	NUT 7/16" X 3/16"
S		10	FLAT WASHER φ7/8" φ5/16" X 1/16"
T		1	ALLEN WRENCH
U		2	METAL CONNECTOR

Parts in L

A		1	P		4
C		1	Q		5
D		1	R		5
G		2	S		5
J		1	T		1
K		1			
N		1			

Parts in R

B		1	M		1
E		1	O		1
F		1	P		4
H		1	Q		5
I		1	R		5
L		1	S		5
			U		2

STEP #1

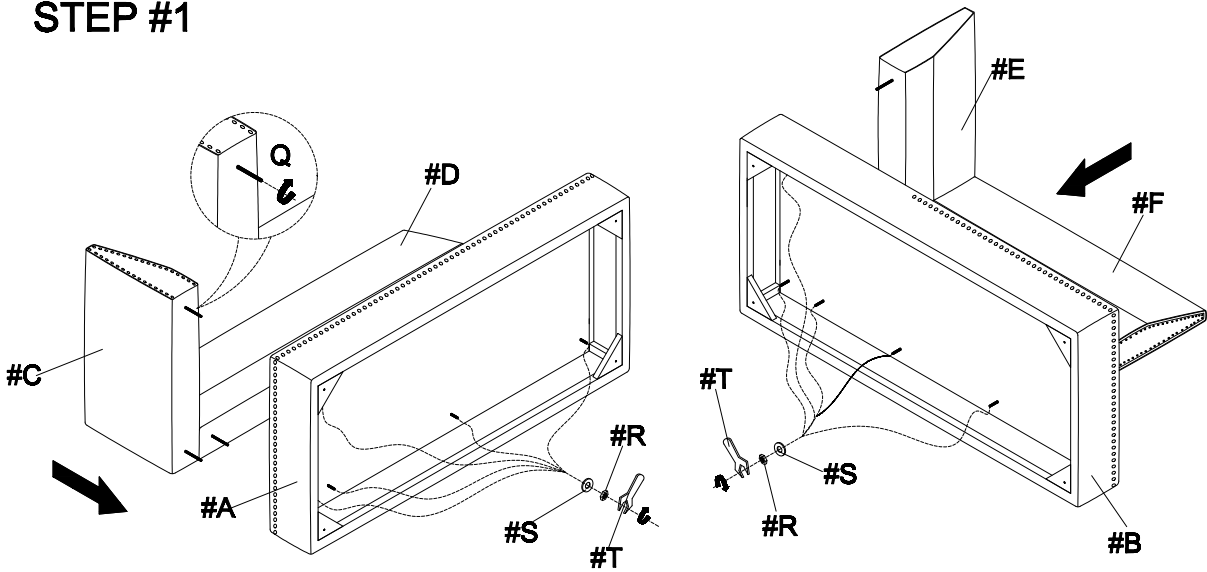

STEP #2

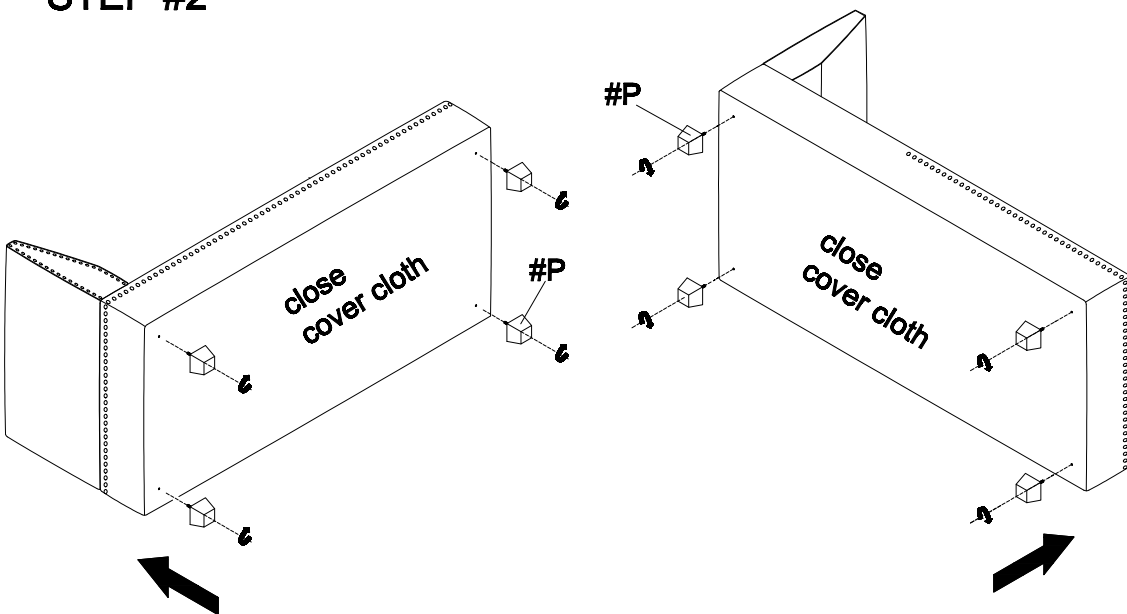

STEP #3

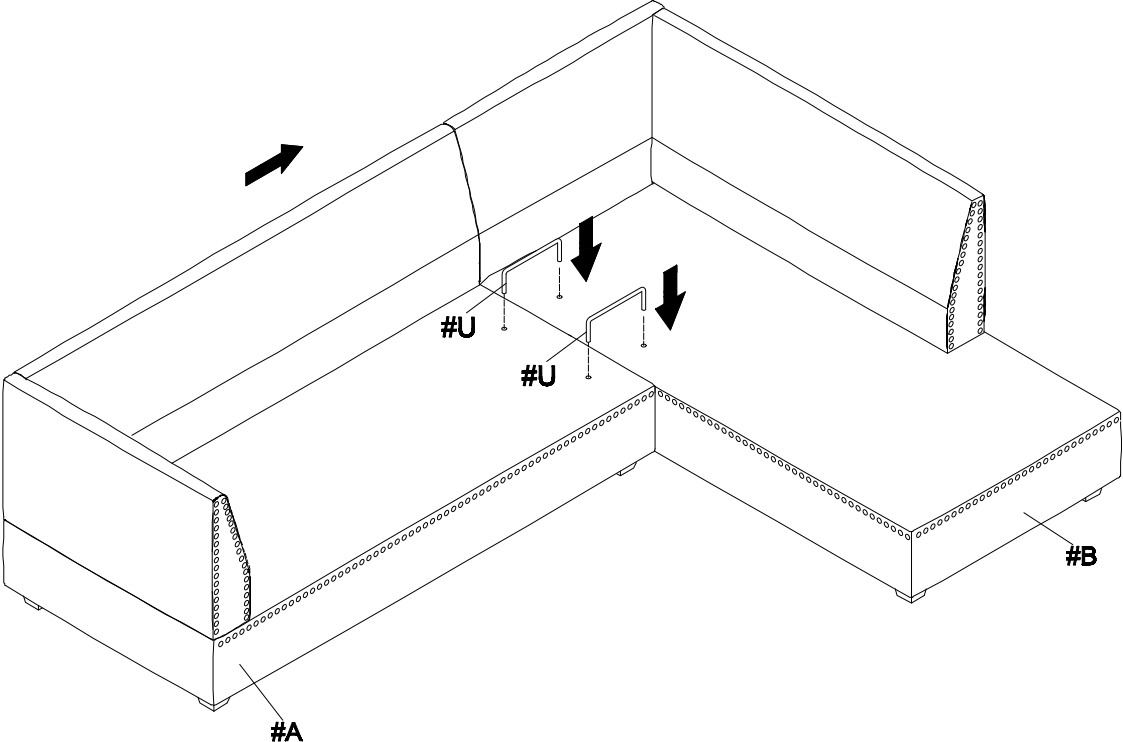

STEP #4

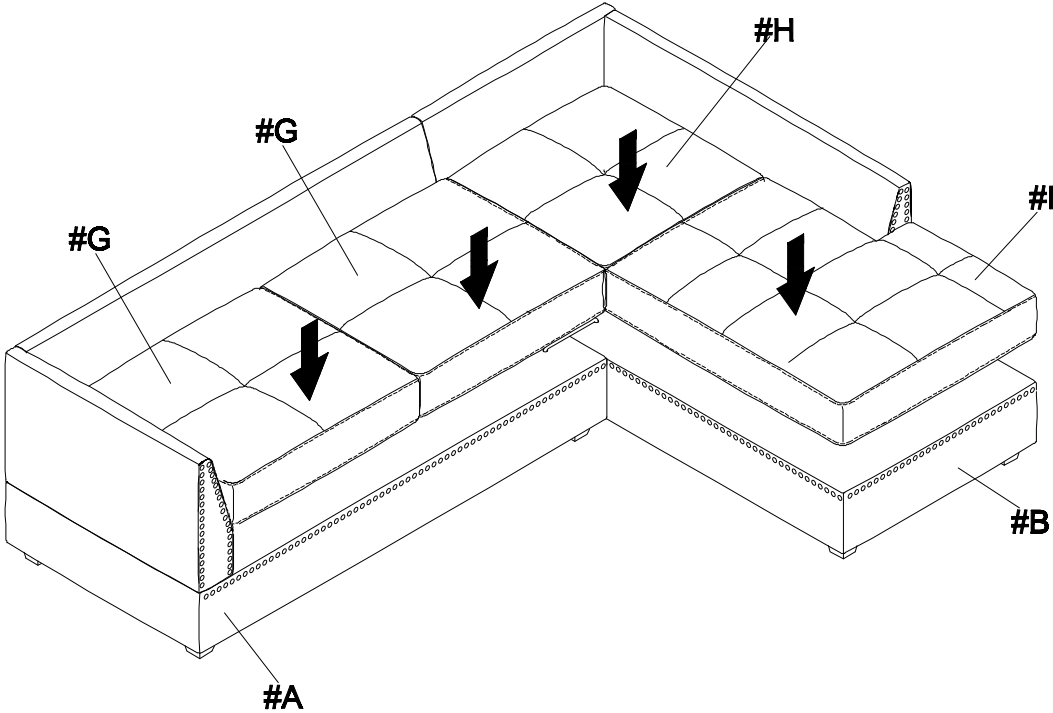

STEP #5

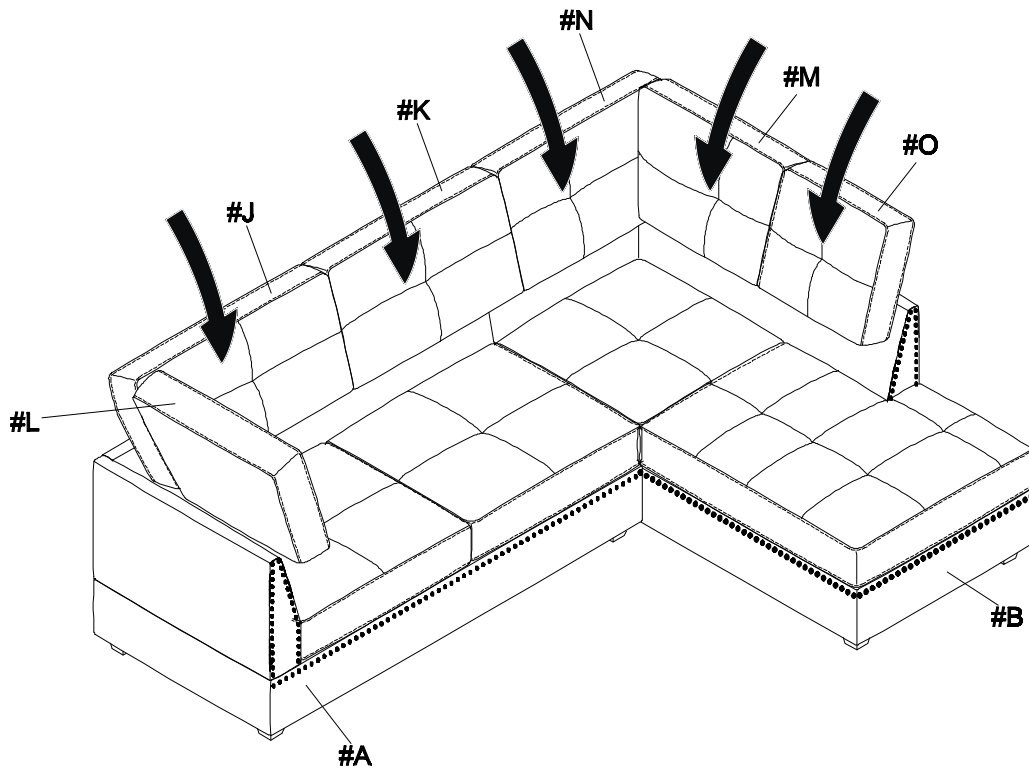

Care instruction for 100% polyester.

In order to maintain the original appearance of your furniture, please follow below simple care procedures:

Avoid exposing furniture directly to sunlight or heating and air conditioning outlet.

Sunlight and/or exposure to heating and air conditioning outlets will fade/damage fabric.

Vacuum or wipe with a soft cloth to remove dust.

Clean fabric with professional cleaner



For item used on wooden floor, hard surfaces or carpets it is recommended to install protective pads under all legs and supports to avoid/prevent from damaged/scratches and discoloration.