

NOTICE

*Please make sure that you have all parts indicated and they are in good condition before you begin assembly of this item. Refer to part list and hardware list below for guidance.

*This item should be assembled on a soft surface to prevent scratching the finish during assembly.

*This item may require periodic tightening.

PREPARATION

* Before beginning assembly of product, make sure all parts are present. Compare parts with part contents list and hardware contents list.

* If any part is missing or damaged, do not attempt to assemble the product.

* Estimated Assembly Time: 10 minutes.

* Tools Required for Assembly (included): Allen Key

CARE AND MAINTENANCE

OUTDOOR FURNITURE CARE

Store outdoor furniture indoors or cover well when not in use. Remove wooden furniture from standing water.

Dust regularly with small brush or vacuum.

Spills should be taken care of immediately before they harden or stain with a slightly dampened sponge.

UPHOLSTERY CARE

To prevent overall soiling, frequent vacuuming or light brushing is recommended. Cushions and pillows should be turned on a weekly basis.

Down-filled cushions should be brushed rather than vacuumed. Spot clean, using a mild water-free solvent or dry cleaning product. Only a professional cleaner should undertake a complete overall cleaning.

The use of steam or water-based cleaners may cause excessive shrinking or staining.

Owner Manual

Product Dimensions: 27.56" W x 29.52" D x 25.0" H

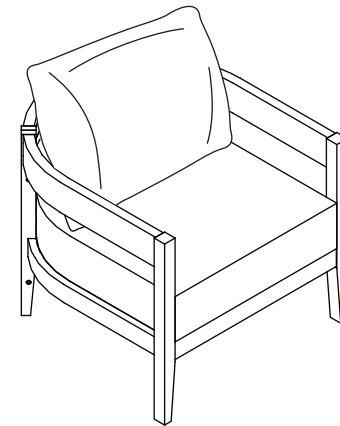



Weight Capacity : 200 lbs





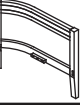
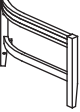

Warning : Do not stand on bench

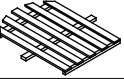
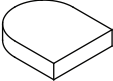
Warning : Do not over torque bolts / screws



Part List and Hardware List

PIECE	DESCRIPTION	PICTURE	QUANTITY
A	Backrest Panel		1X
B	Left Leg Panel		1X
C	Right Leg Panel		1X
D	Support Bar		1X
E	Seat Panel		1X
CSH1	Seat Cushion		1X

CSH2	Back Cushion		1X
HW1	Allen Bolt: M6x0.5x30 mm	 M6x30	4X
HW2	Allen Bolt: M6x0.5x45 mm	 M6x45	4X
HW3	Screws M6x0.5x35 mm	 M6x35	2X
HW4	Insert Nut	 M6x15	4X
HW5	Screws M6x0.5x45 mm	 M6x45	2X
HW6	Allen key	 LG4	2X

PREPARATION

- *Before beginning assembly of product, make sure all parts are present. Compare parts with package contents list and hardware contents list.
- *If any part is missing or damaged, do not attempt to assemble the product.
- * Estimated Assembly Time : 10 minutes.
- * Tools Required for Assembly (included): Allen Key
- * If you are having difficulty, our friendly Customer care team is always here to help.

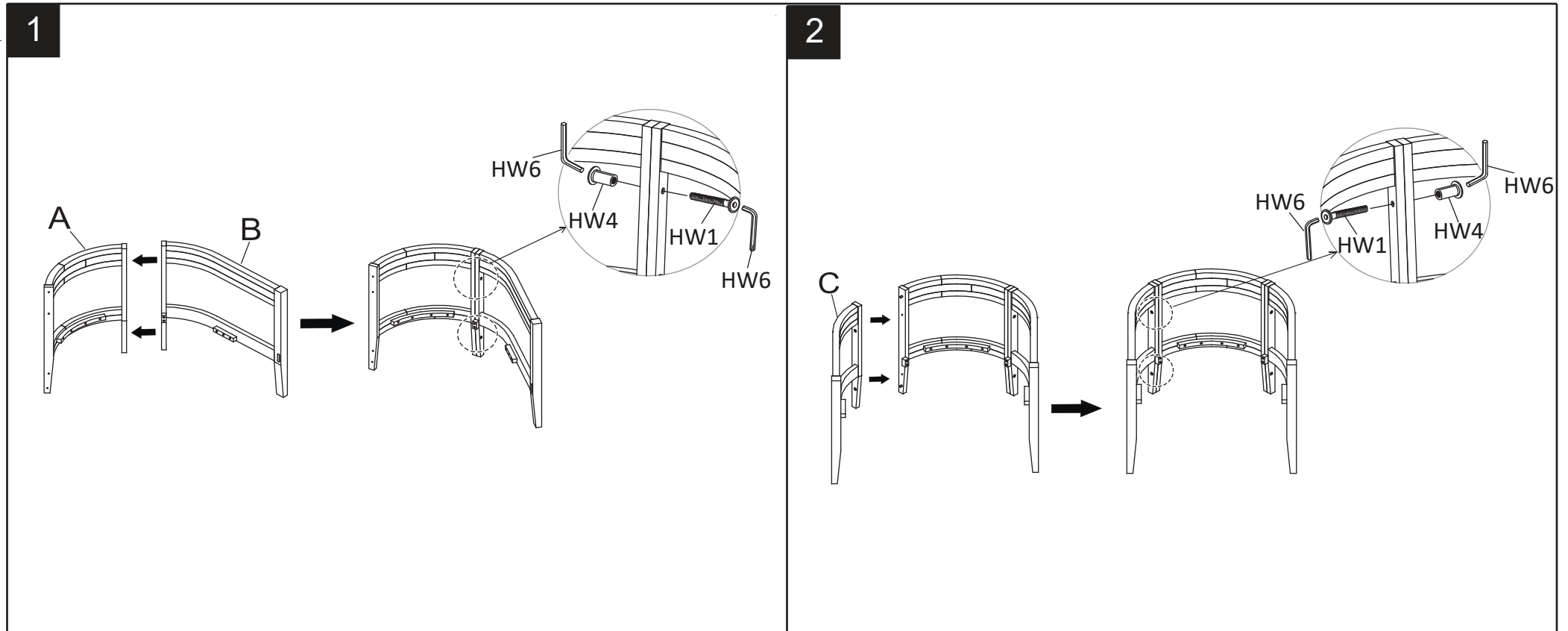

Step 1

Attach the Left Leg Panel (B) to the Backrest Panel (A) using Bolts(HW1), Insert Nuts(HW4) and the Allen kay (HW6) as shown above.

Step 2

Attach the Right Leg Panel (C) to the Backrest Panel (A) using Bolts(HW1), Insert Nuts(HW4) and the Allen kay (HW6) as shown above.

PREPARATION

- * Before beginning assembly of product, make sure all parts are present. Compare parts with package contents list and hardware contents list.
- * If any part is missing or damaged, do not attempt to assemble the product.
- * Estimated Assembly Time : 10 minutes.
- * Tools Required for Assembly (included): Allen Key
- * If you are having difficulty, our friendly Customer care team is always here to help.

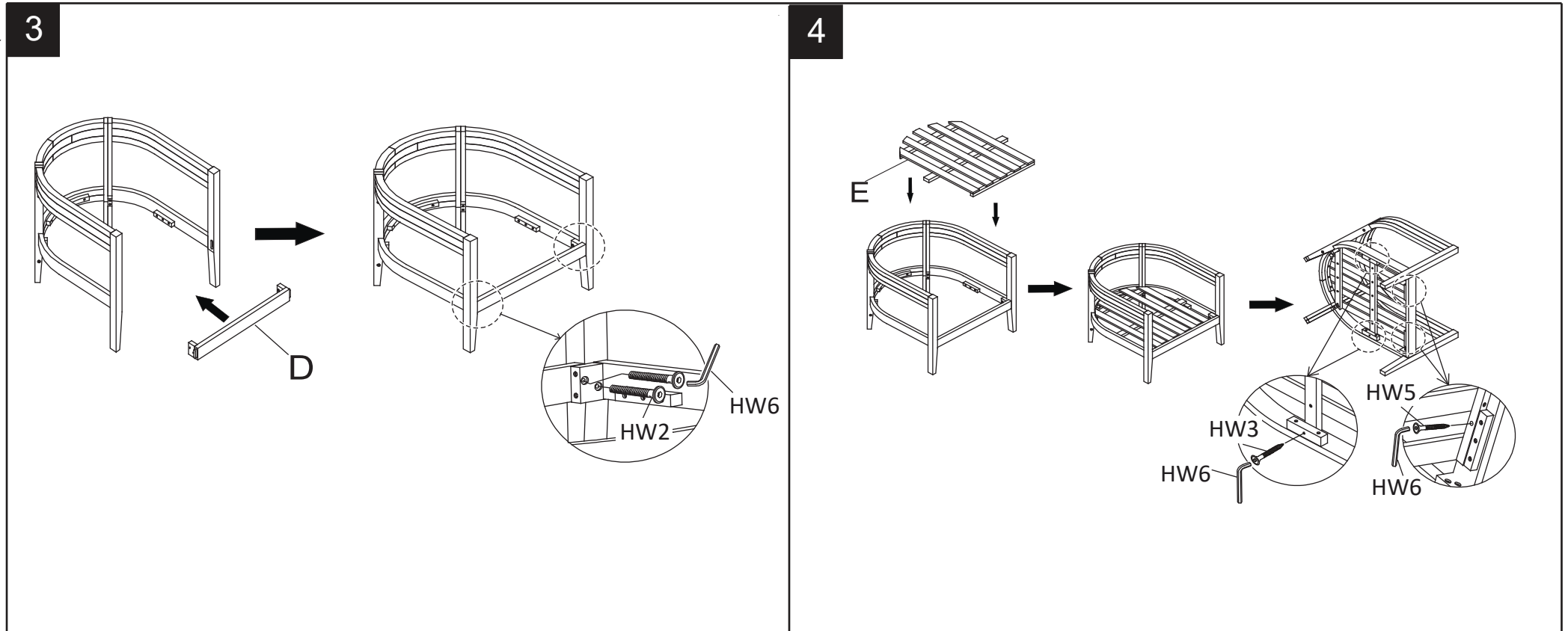

Step 3

Attach the Support Bar (D) to the assembled frame in step 3 by using Bolts(HW2) and the Allen key (HW6) as shown above.

Step 4

Attach the Seat Panel (E) into the Chair as shown in picture above. Affix the Seat Panel (E) to the Chair using Screws(HW3),(HW5) and the Allen (HW6). Note: Insert the Screws(HW3),(HW5) from the inside to the outside of the Seat Panel(E)

PREPARATION

- *Before beginning assembly of product, make sure all parts are present. Compare parts with package contents list and hardware contents list.
- *If any part is missing or damaged, do not attempt to assemble the product.
- * Estimated Assembly Time : 10 minutes.
- * Tools Required for Assembly (included): Allen Key
- * If you are having difficulty, our friendly Customer care team is always here to help.

5

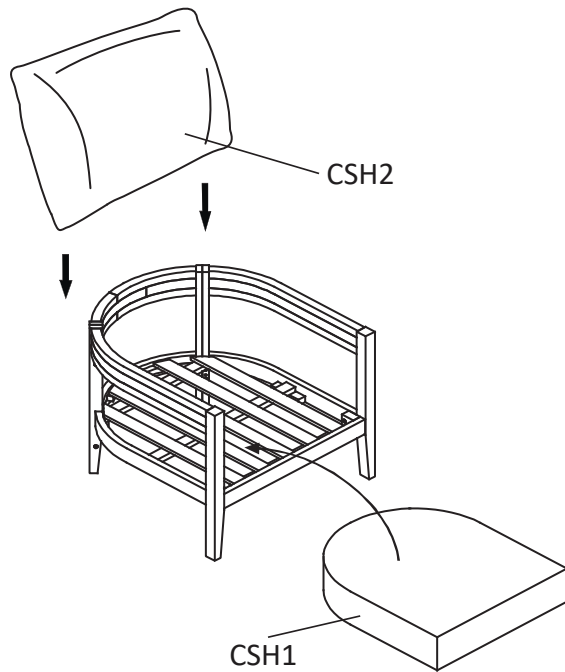

6

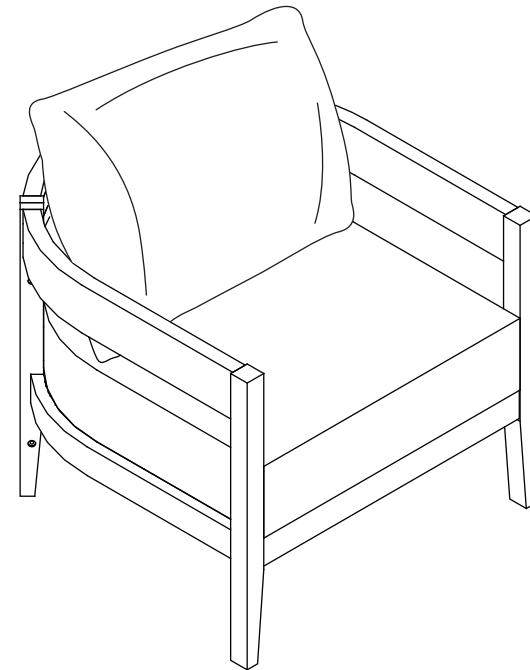

Step 5

Place the Seat Cushion (CSH1) and the Back Cushion (CSH2) into the Chair.

Step 6

Your Chair is ready to be used.