

# ASSEMBLY INSTRUCTIONS

## BED - KING

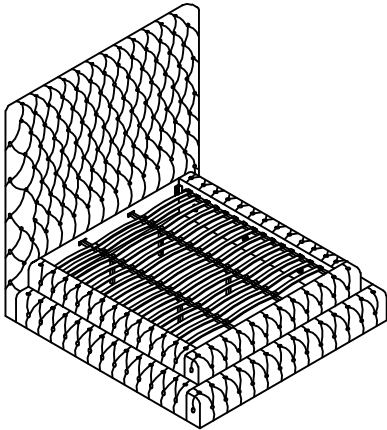

### + Parts Included

① Head Board (1pc)

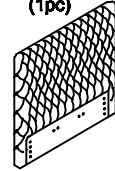

② Inside Foot Board (1pc)

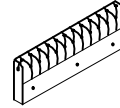

③ Inside Side Rails (2pcs)

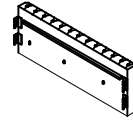

④ Outside Side Rails (2pcs)

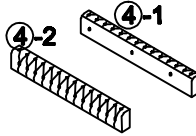

⑤ Center Support Bar (2pcs)



⑥ Support Legs (4pcs)



⑦ Outside Foot Board (1pc)

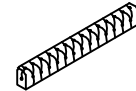

⑧ Double Plastic cap (30pcs)



⑨ Single Plastic cap (30pcs)



⑩ Slats (45pcs)



\*Slats come packed in the bottom of headboard carton.

### + Do Not Use Power Tools



### + Suggested Adults

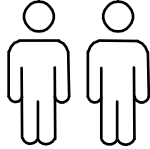

#### NOTE:

- 1 Read instructions cover to cover.
- 2 Save all packaging until assembly is completed.

### 1 IMPORTANT SAFETY INFORMATION

Do not assemble the product if any of the following parts arrived damaged:

- Part # ③/④ - Side Rails
- Part # ⑤ - Center Support Bar
- Part # ⑥ - Support Legs
- Part # ⑩ - Slats

### 2 IMPORTANT ASSEMBLY INFORMATION

Assembly Step ③ Ensure the side rail bracket is fully hooked onto bolt C loosely threaded with both washers on the OUTSIDE of the bracket first, then proceed to fully tightening all 4 corners.

Assembly Step ⑩ When installing slats, ensure that the curve is facing upwards. (→) (↘)  
\*Slats come packed in the bottom of headboard carton.

### + Hardware Included

A Bolt M8\*30mm (16pcs)



B Bolt M8\*200mm (9pcs)



C Bolt M8\*40mm (16pcs)



D Spring Washer (16pcs)



E Flat Washer φ20 (32pcs)



F M8 Allen Key (1pc)



G Flat Washer φ22 (9pcs)



I Nut M8\*13mm (17pcs)



J Spanner (1pc)



# ASSEMBLY INSTRUCTIONS

## BED - KING

