

Assembly Instruction

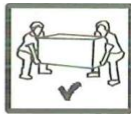

ASSEMBLY TIME PER UNIT:

20MINUTES

PARTS IDENTIFICATION

A BACK

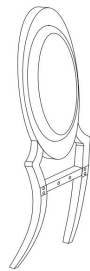

1PC

HARDWARE LIST

B SEATER

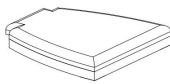





1PC

B LEGS



2PCS

NO.	SIZE	DIAGRAM	QTY
1	Allen wrench		1
2	Bolts M8x25		12
3	spring shim		12
4	Flat washer		12

C:LEGS

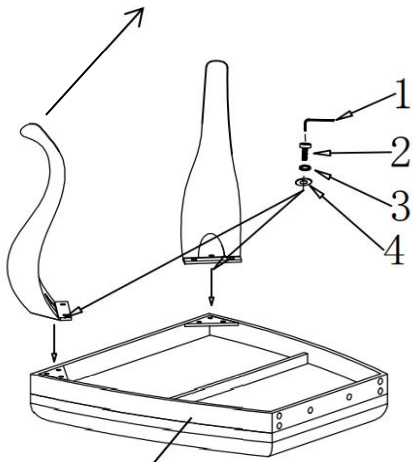

B:SEATER

