









ASSEMBLY INSTRUCTIONS

Read this instruction carefully. See hardware and furniture part list for guidance. Be sure all parts are complete, before you assemble. Place all wooden furniture parts on a clean and flat soft surface to prevent from being scratched. Follow the figure to start assembling.

CAUTIONS : 1. Do not FULLY - TIGHTEN the nut or nut bolt until all nut or bolt is ready assembled.
2. Do not OVER - TIGHTEN the nut or bolt to avoid causing damages to the thread.
3. Keep all hardware parts out of reach of children.

NOTE : THE LIST AND QUANTITY SHOWN ARE FOR 1 UNIT ASSEMBLY.

PART LIST		
ITEM	DESCRIPTION	QTY
A	BACK	1 PC
B	SEAT	1 PC
C	ARM	2 PCS
D	FRONT RAIL	1 PC

PART LIST		
ITEM	DESCRIPTION	QTY
1	JCBB Bolt M8 x 40mm 	2pcs
2	JCBB Bolt M8 x 50mm 	4pcs
3	JCBB Bolt M8 x 60mm 	6pcs
4	M8 Flat Washer 	6pcs
5	M8 Spring Washer 	6pcs
6	Wood Dowel M10 x 40mm 	2pcs
7	M8 Bran Nut 	2pcs
8	Wood Button Dia 18.5mm 	6pcs
9	M5 Allen Key (Ball Shape) 	1pc

STEP 1

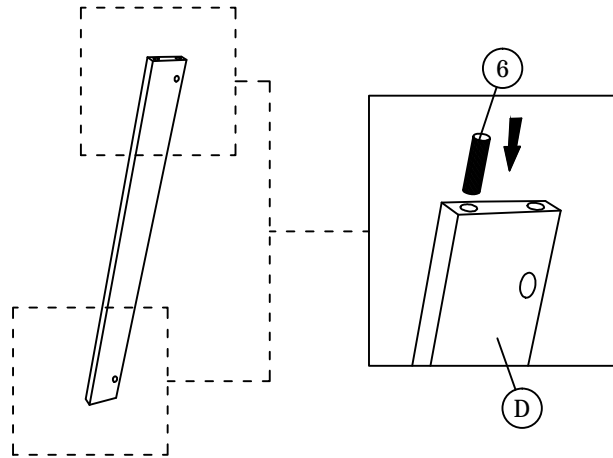

STEP 2

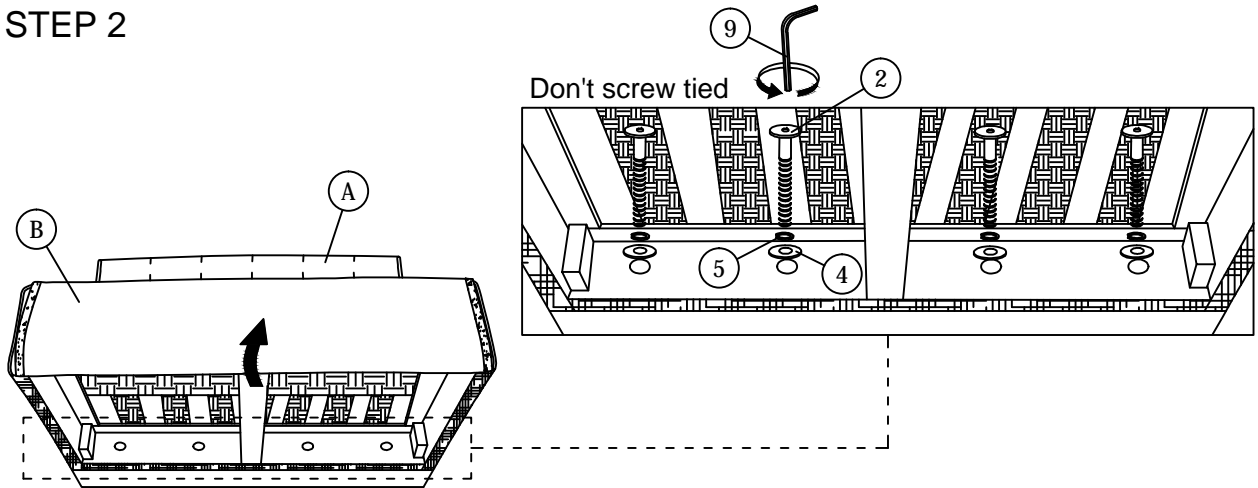

STEP 3

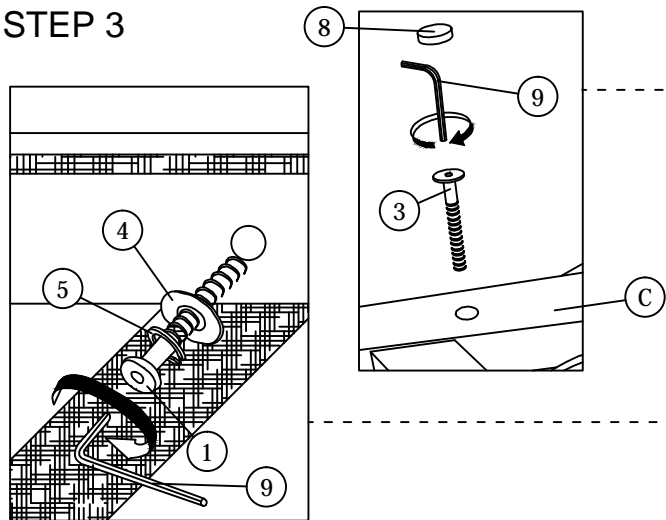

STEP A

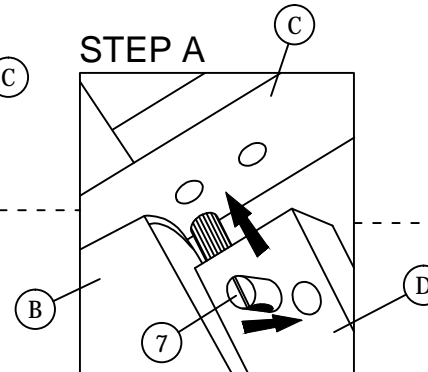

STEP B

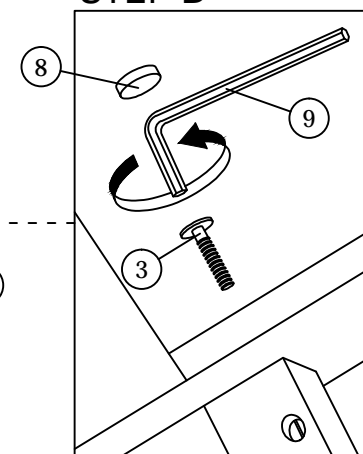

STEP 4

STEP B

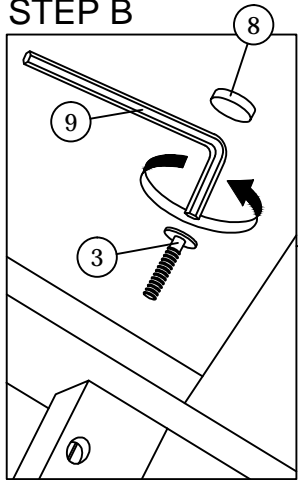

STEP A

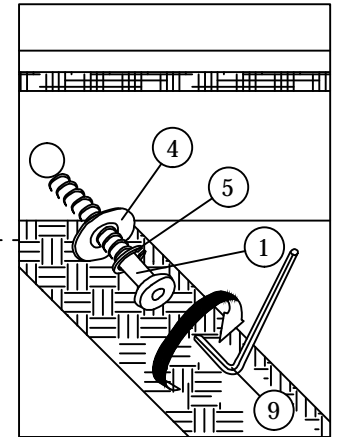
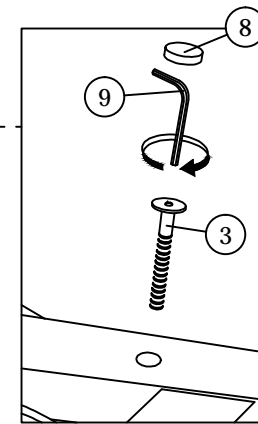
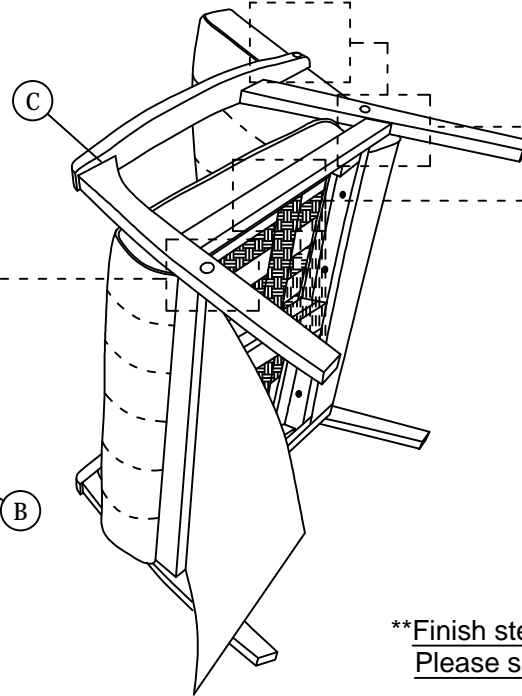
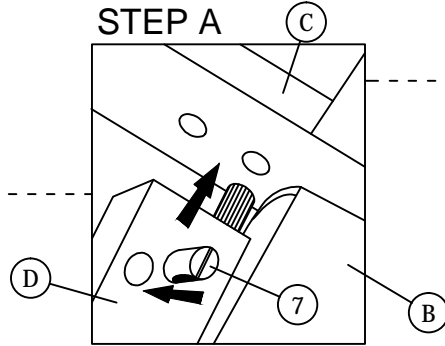

****Finish step 4,
Please screw tied the step 2 bolt.**

STEP 5

