

# ASSEMBLY INSTRUCTION

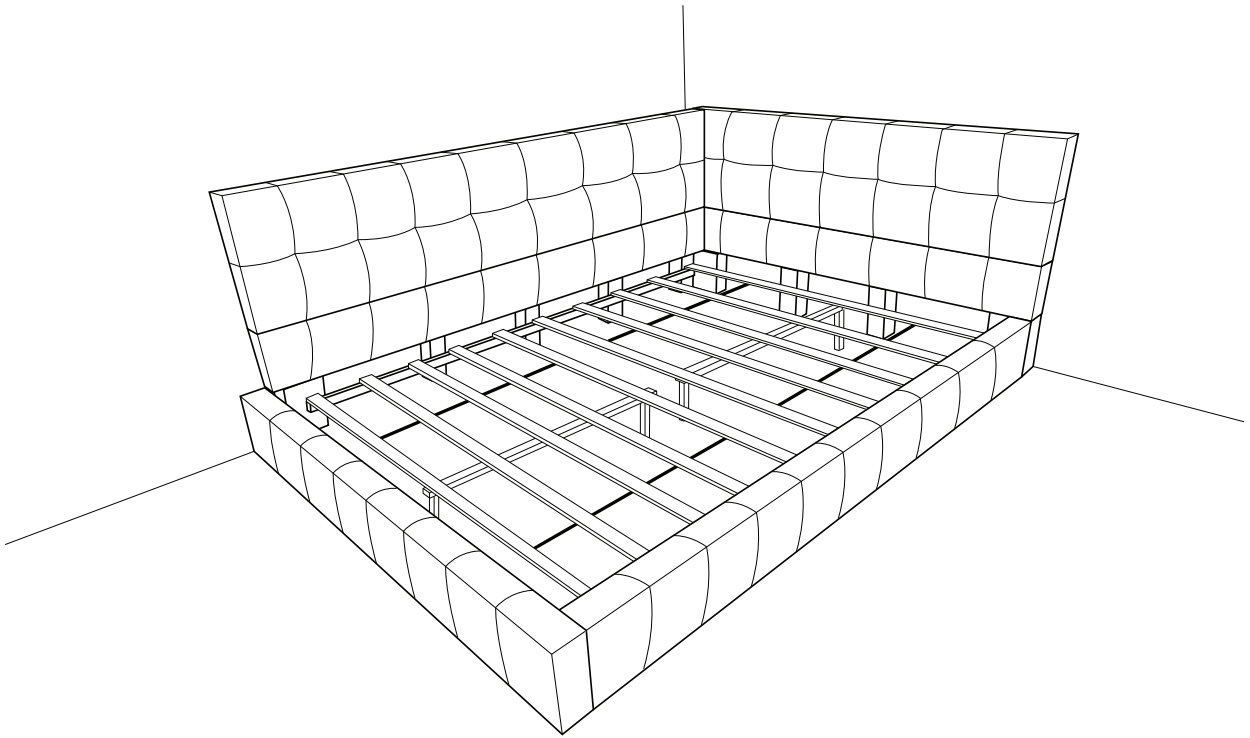

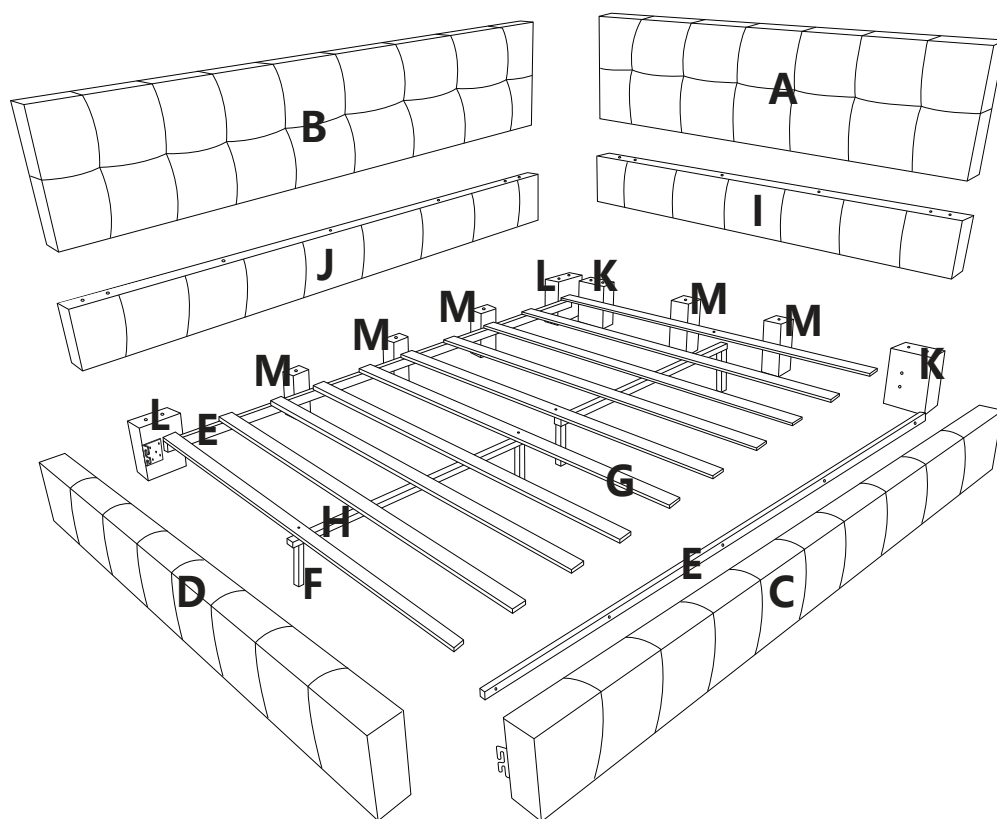



Detail View - CORNER BED (FULL)

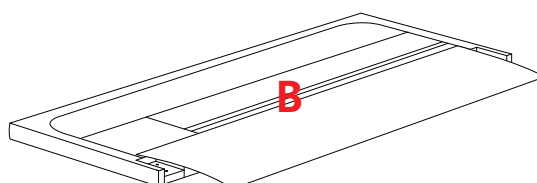

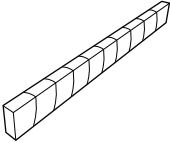
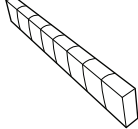
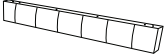
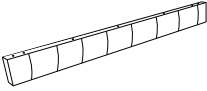
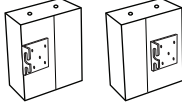

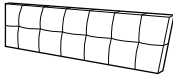
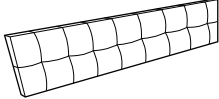
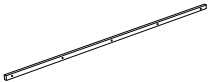
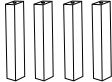
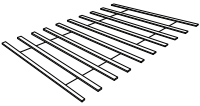
Bed Parts are shipped inside a compartment  
in th back of the headboard.

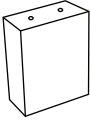

NO	PART LIST	QTY
C	Side Rail 	1 pc
D	Footboard 	1 pc
I	Headboard Lower Panel 	1 pc
J	Side Rail Lower Panel 	1 pc
L	Large Bottom Leg (with bracket) 	2 pcs

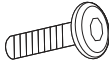
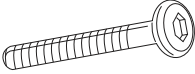
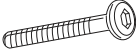
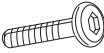
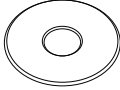
NO	PART LIST	QTY
A	Headboard Upper Panel 	1 pc
B	Side Rail Upper Panel 	1 pc
E	Slat Support 	2 pcs
F	Center Support Leg 	4 pcs
G	Bed Slat 	10 pcs
H	Center Support Rail 	2 pcs
K	Large Bottom Leg 	2 pcs
M	Small Bottom 	5 pcs

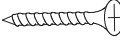
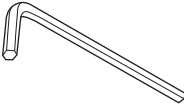
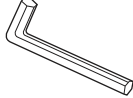
NO	HARDWARE LIST	QTY
1	JCBB M8 x 20mm 	8 pcs
2	JCBC M6 x 60mm 	4 pcs
3	JCBC M6 x 40mm 	19 pcs
4	JCBC M6 x 30mm 	13 pcs
5	Flat Washer M6 	22 pcs
6	Adjuster M6 	4 pcs
7	CSK M4 x 30mm 	20 pcs
8	Allen Key M4 	1 pc
9	Allen Key M5 	1 pc

Read this instruction carefully. Remove all wrapping material, staples and straps from the carton. See hardware and furniture part list for guidance. Be sure you have all wooden furniture parts on a clean and flat surface, such as carpet or rug, to prevent from being scratched.

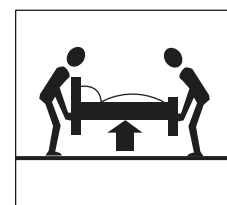
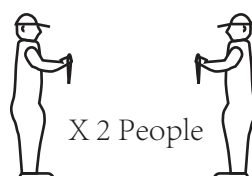

**CAUTION :**

1. Do not Full Tighten the nut or screw until all ready to assemble.
2. Do not Over Tighten the nut or screw to avoid causing damages to the thread.
3. Keep all hardware part out reach of children.

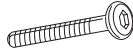
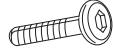

# STEP 1

REMINDER: Please decide your bed placing angle before proceed assemble, kindly refer below Option 1 & Option 2 photos.

3	4	5
		
9 pcs	13 pcs	22 pcs

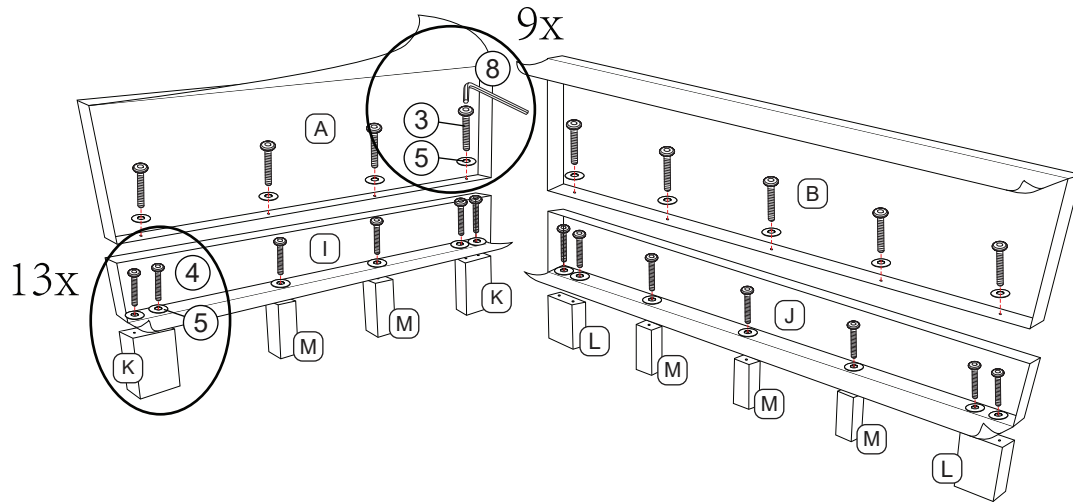

# STEP 2

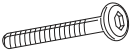
3

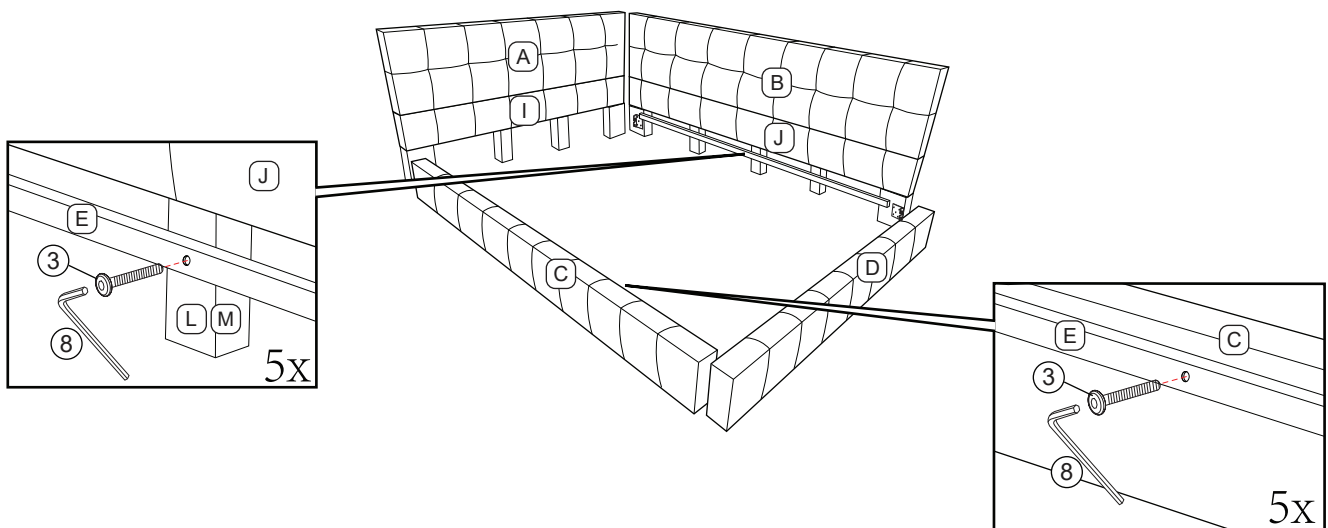
10 pcs

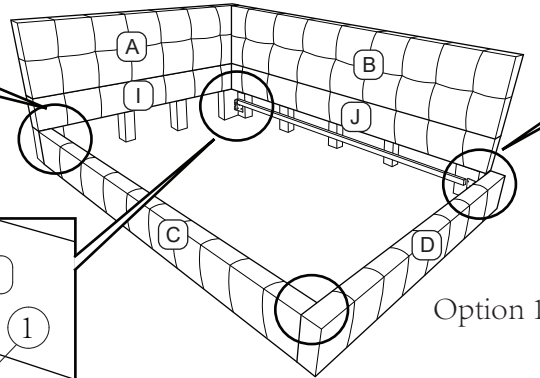
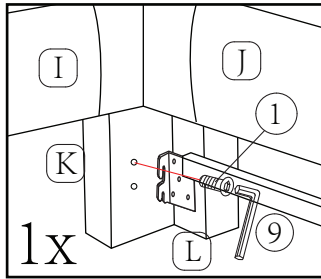
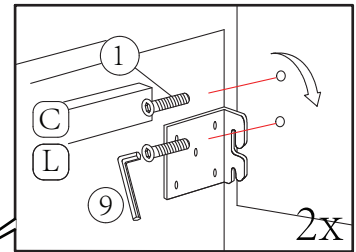
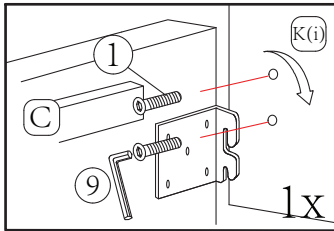
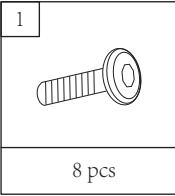
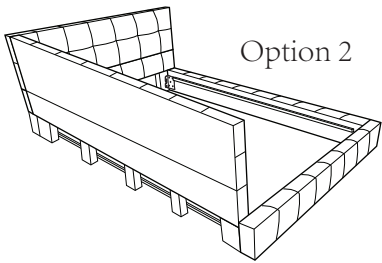

STEP 3

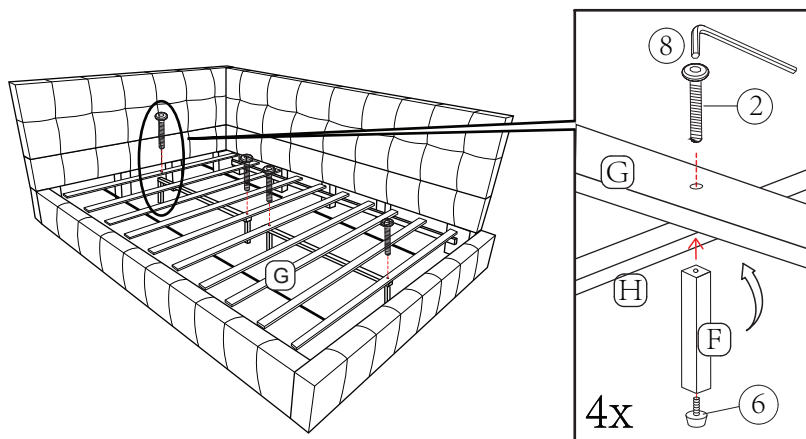
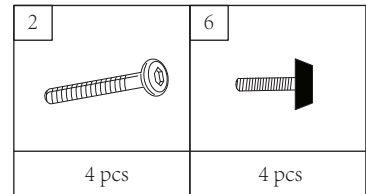

STEP 4



STEP 5

7



20 pcs

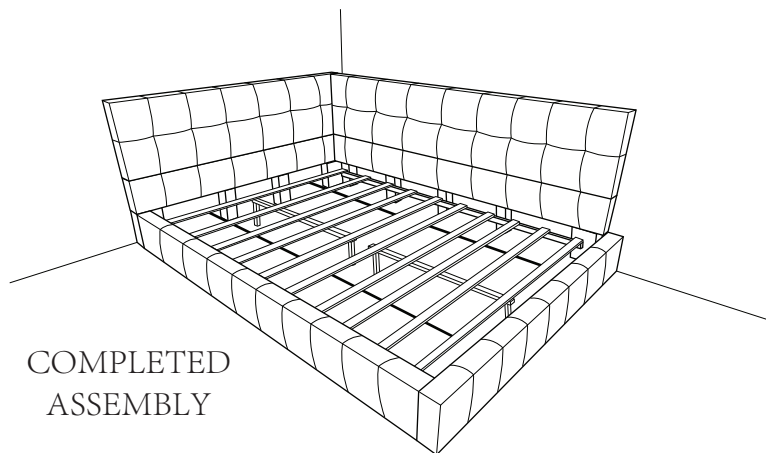
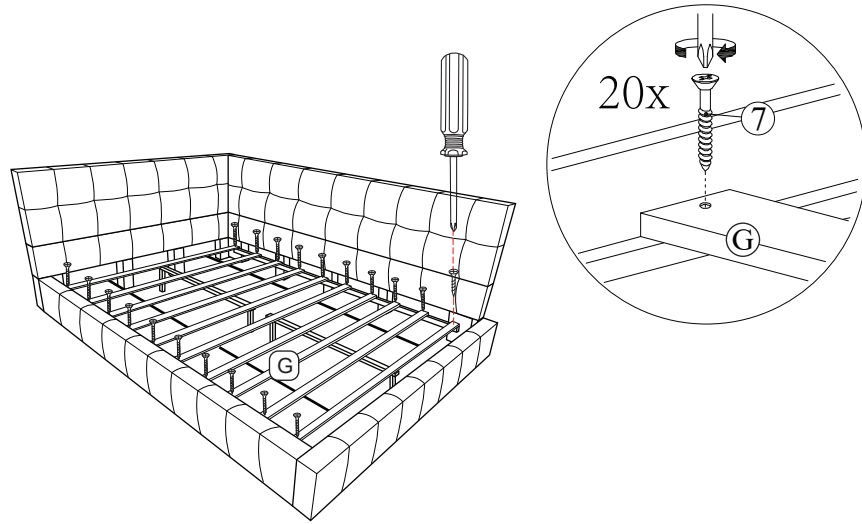

COMPLETED  
ASSEMBLY