

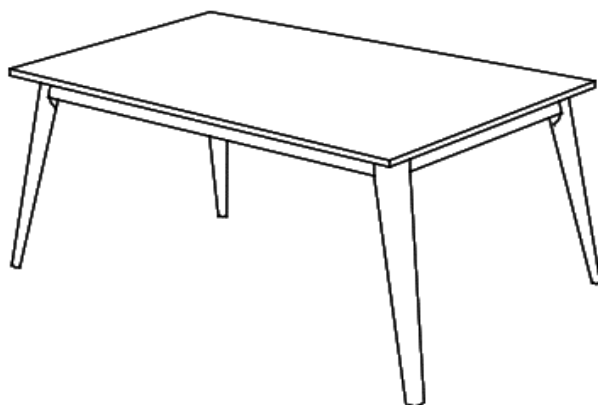

Assembly Instructions

Caution : You must read this before you proceed



DINING TABLE



Parts list

Label	Picture	Description	QTY
A		Table Top	1
B		Leg	4





Hardware

Label	Picture	Description	QTY
①		JCBB SEMS Bolt (M8 x 60mm)	9
②		Allen Key (M5mm)	1

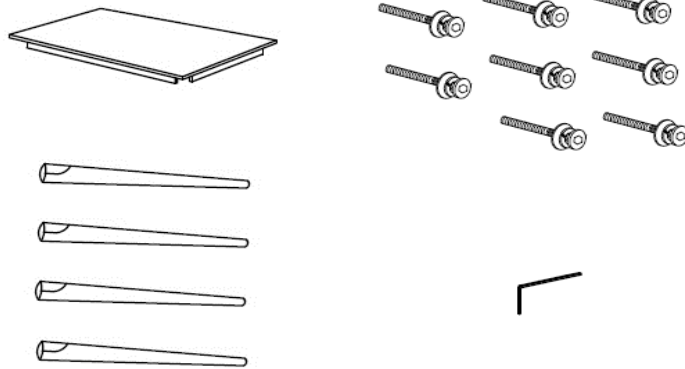
Assembly Preparation

Before Beginning Assembly:



-  • Read instructions, cover to cover-
-  • Have 2 adults on hand for assembly-
-  • Do not assemble on flooring or carpet-
-  • Assemble on a clean non-marring surface (packing foam)-
-  • Save all packaging until finished-

Assembly Steps

Overview

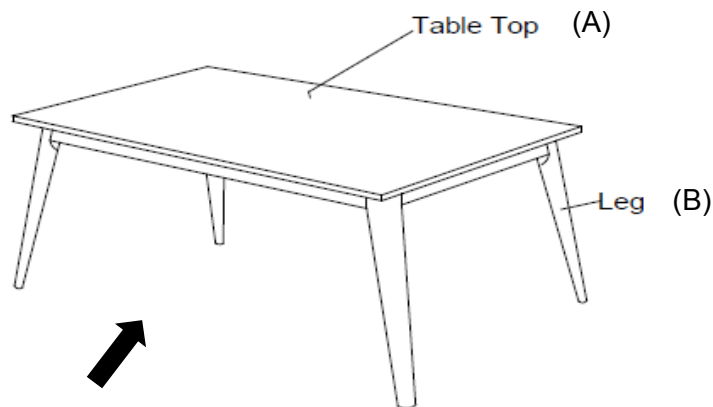

This table has multiple parts and may require up to 30 minutes to assemble. To give you an overview of the parts, the above picture is to help you put the various parts into perspective. Please read through the instructions herebelow to familiarise the parts and steps before assembly.

Step 1

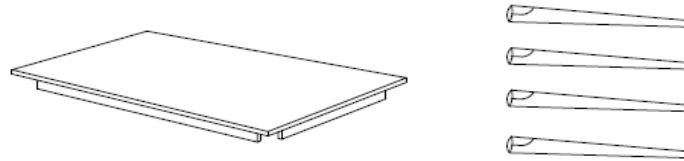

Unpack and place all parts on a clean, non-marring surface.

Step 2

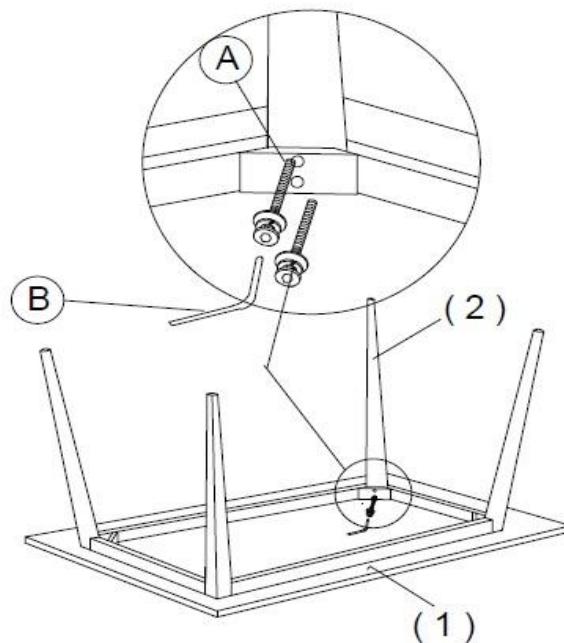

Place the table (A) onto a clean, soft surface to avoid any scratches or damages to the product.

Align the leg (B) into the mortise table (A) as shown above.

Then insert a JCBB SEMS (①) into hole coner.

Tighten screw with Allen key (②). See the detail.

Do not fully tighten the Bolts.

Step 3

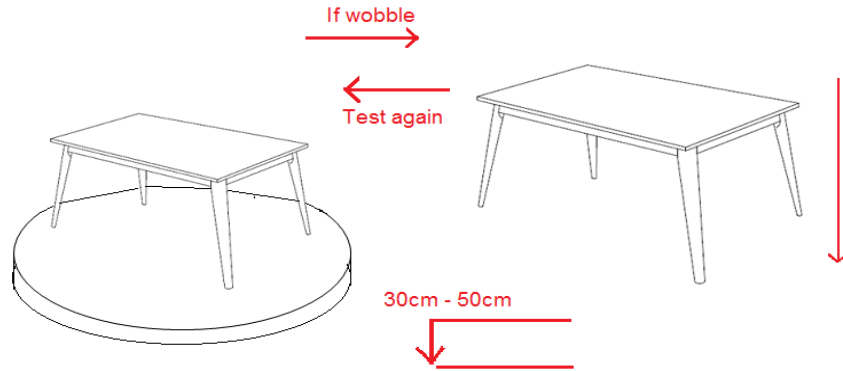

Turn the table side up.

Inspect it and make sure all parts are adequately connected.

Place the Table on a LEVEL SURFACE to see if it wobbles.

If it wobbles, lift the Table some 30cm to 50cm high from the ground.

Keep your feet and toes well away from the drop zone.

Drop the product freely and vertically with the four legs, hitting the ground, at the same time.

This Drop Test will help to ensure that all parts and gaps reach full alignment status.

Test again for evenness on a LEVEL SURFACE.

If no wobbles found, proceed to tighten all the Bolt and Screws at all joints.

When tightening the Bolts and Screws, tighten sequentially.

DO NOT tighten any Bolt or Screw fully and then move on towards the next one.

This would cause the frame to warp.





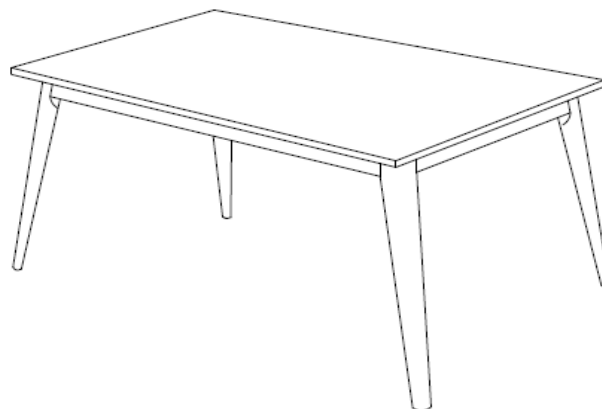

















If there is still wobbles, loosen the Bolts and execute this same drop test.

Step 4



Turn the table side up. Place the table on a LEVEL SURFACE. Inspect it and make sure all parts are adequately connected.

Care & Maintenance

-   • Furniture may scratch floors. We recommend using furniture pads to protect your floors.
 -   • Do not put hot items directly on furniture surface.
 -   • Do not clean furniture with harsh cleansers or polish.
 -   • To obtain the longest lifespan of your outdoor products, minimizing exposure to direct sunlight is recommended.
 -   • Children should not climb or jump on the furniture.
 -   • Do not write on furniture without a padded barrier to protect the surface.
 -   • To obtain the longest lifespan of your outdoor products, avoid extended and lengthy exposure to rain, snow, and direct sunshine. Whenever possible cover the product and /or place under patio or awnings.
 -   • Not for commercial use. For residential use only.
 -   • Stains may be removed with mild soap solution and damp cloth.
 -   • Keep away from sources of ignition.
-
-   • Dust and pick-up spills using a clean, non-colored, lint-free cloth.