

ASSEMBLY INSTRUCTIONS



Fine Furniture for every stage of life

Sofa Bed

ASSEMBLY INSTRUCTIONS

ASSEMBLY TIPS:

1. Remove hardware from box and sort by size.
2. Please check to see that all hardware and parts are present prior to start of assembly.
3. Please follow attached instructions in the same sequence as numbered to assure fast & easy assembly.



WARNING!



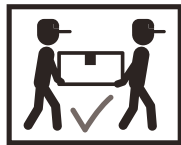

1. Don't attempt to repair or modify parts that are broken or defective. Please contact the store immediately.
2. This product is for home use only and not intended for commercial establishments.





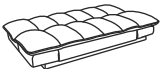

ASSEMBLY TIME

30 MINUTES

PARTS IDENTIFICATION

A	SOFA BED		1PC	C	BACK LEG		2PCS
B	FRONT LEG		2PCS	D	MIDDLE LEG		1PC

Z HARDWARE IDENTIFICATION

Z01	BOLT (8 x 30mm - BLK)		4PCS	Z03	ALLEN WRENCH (D 5mm - BLK)		1PC
Z02	WASHER (10 x 25mm - BLK)		4PCS	Z04	PLASTIC WASHER (D 50mm - BLK)		2PCS

STEP 1

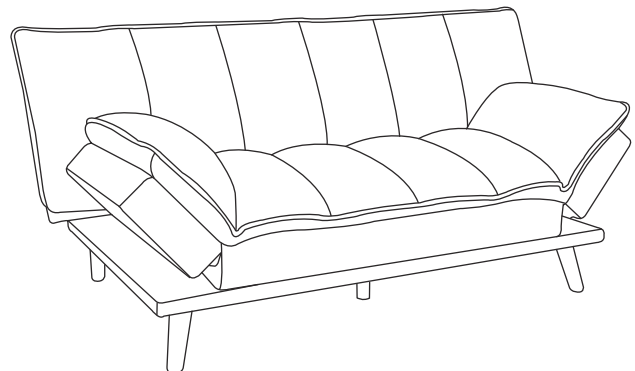
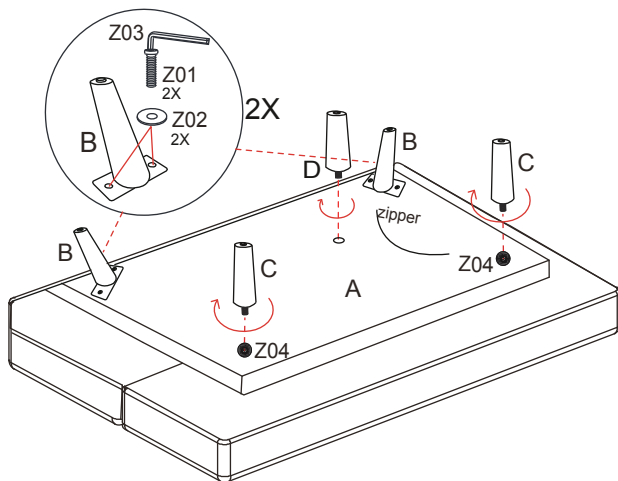

ASSEMBLY INSTRUCTIONS

PRODUCT DIMENSION (Note: Dimension tolerance $\pm 5\%$)

