

SOFA TABLE

ASSEMBLY INSTRUCTION



ASSEMBLY INSTRUCTION

ASSEMBLY TIPS:

- 1.Remove hardware from box and sort by size.
- 2.Please check to see that all hardware and parts are present prior to start of assembly.
- 3.Please follow attached instructions in the same sequence as numbered to assure fast & easy assembly.



Warning!!

- 1.Don't attempt to repair or modify parts that are broken or defective. Please contact the store immediately.
- 2.This product is for home use only and not intended for commercial establishment.

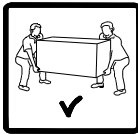



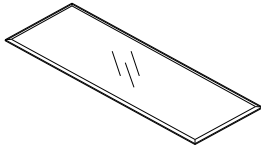
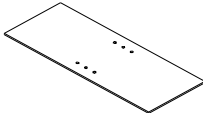
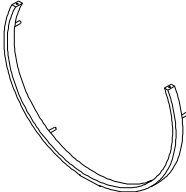
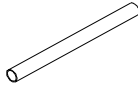

ASSEMBLY TIME PER UNIT: 28 MINUTES





PARTS IDENTIFICATION

<p>A</p> <p>TOP GLASS  1PC</p>	<p>B</p> <p>BOTTOM HALF MIRROR  1PC</p>
<p>C</p> <p>SUPPORT FRAME  2PCS</p>	<p>D</p> <p>CROSSBAR  4PCS</p>

HARDWARE PACKAGE

Z	DESCRIPTION	FIGURE	Q'TY
1	BOLT (5/16"x25mm)		6PCS
2	SHORT BOLT (3/16"x8mm)		8PCS
3	WASHER (5/16")		6PCS
4	PLASTIC WASHER (5/16")		6PCS

ASSEMBLY INSTRUCTION

5	SUCTION CUP (φ 8mm)		4PCS
6	FOOT PAD (φ 40x20mm)		4PCS
7	SPRING WASHER (5/16")		6PCS
8	LARGE ALLEN WRENCH (5mm)		1PC
9	SMALL ALLEN WRENCH (4mm)		1PC

STEP 1

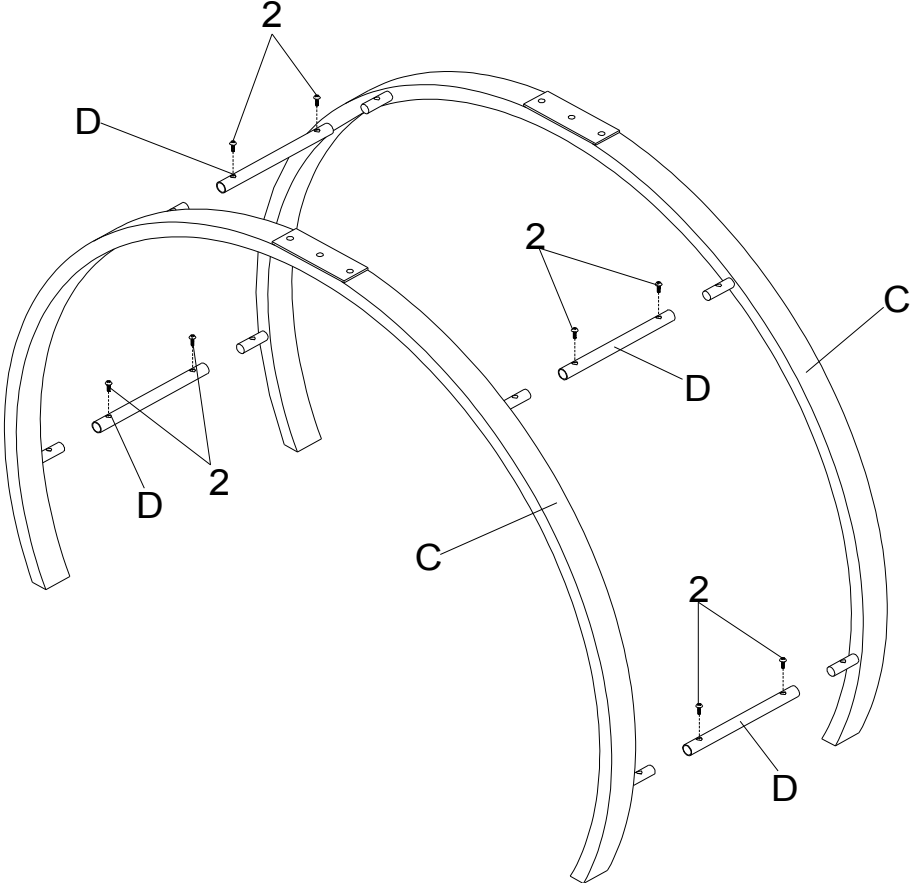

STEP 2

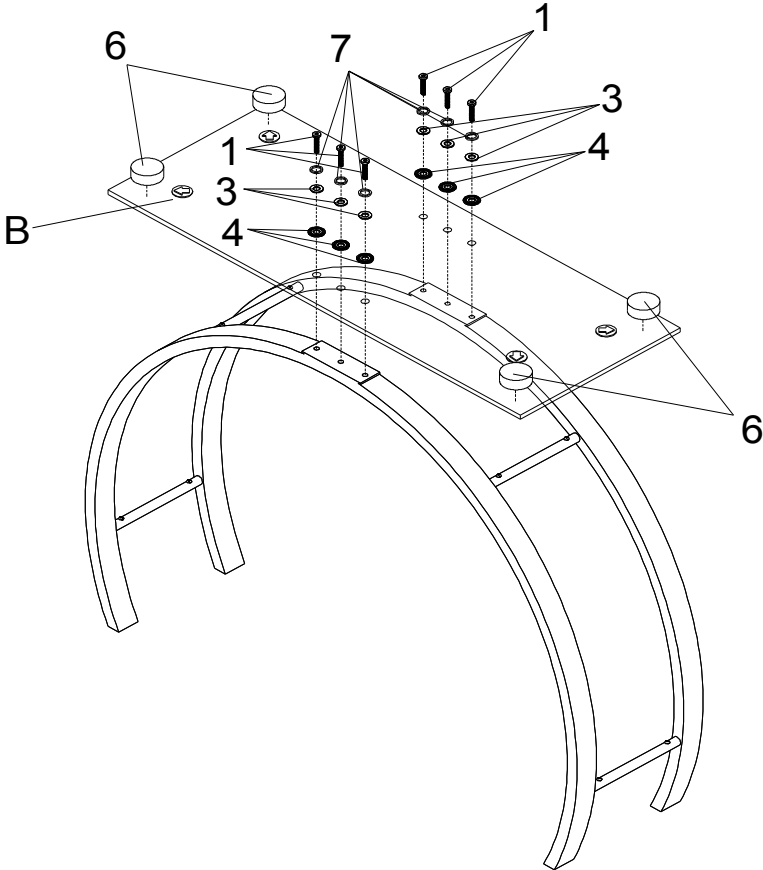

FINISH

