

OWER MANUAL

Freya Office Chair



Before starting assembly, carefully open the packaging and identify each component. Before starting, please refer to the parts list to ensure that you have all the parts. Please be careful when assembling the equipment and always place the parts on a clean and soft surface.

PRE-ASSEMBLY PREPARATION

-Note : Assembly is recommended for two adults. Do not use power tools. Please inspect all items BEFORE assembly. If for any reason you need to return this item, please kindly return it in it's original packaging.





-WARNING!

1. DO NOT let any sharp objects touch or rub the surface of the product.
2. When assembling, do not let children play around the working area.
3. DO NOT USE if this product become damaged, and/or components are broken or missing.

-CARE AND CLEANING: DO NOT scratch or chip the finish. DO NOT use abrasive chemicals for cleaning. Clean with mild soap on a soft rag. Rinse and dry thoroughly.

-MAINTENANCE: Please periodically check all fittings and re-tighten as necessary.

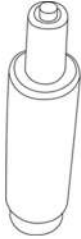
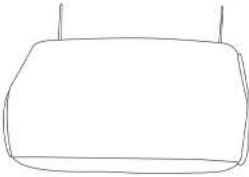
PARTS LIST

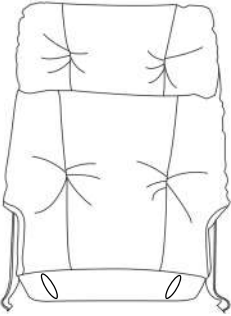
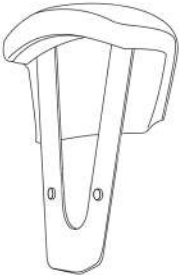
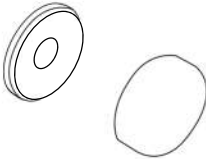
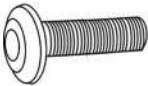
CASTERS*5 	STAR BASE 	GAS LIFT 	SEAT CUSHION 	WRENCH 
BACK CUSHION 	ARMS*2 	PLASTIC CAPS *4 	BOLTS * 4 	

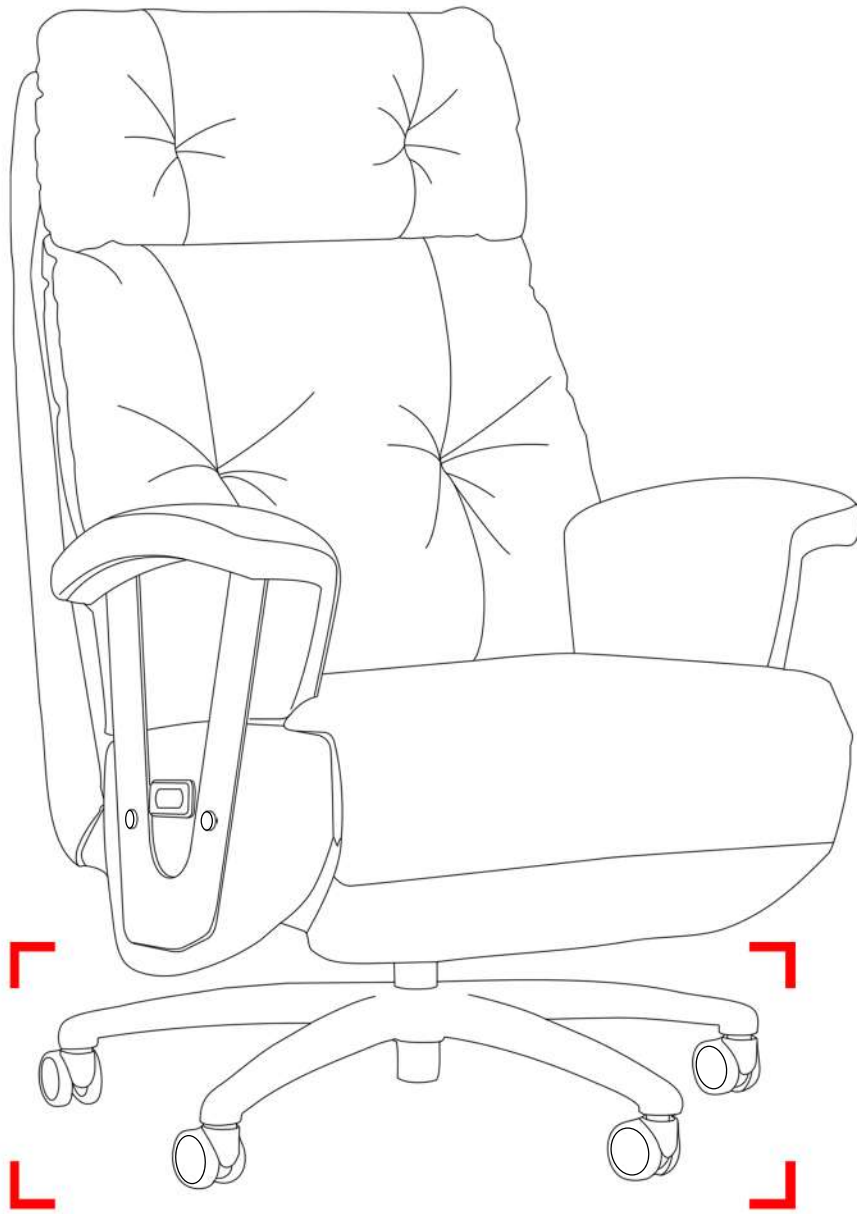

Flip the Star Base upside down, then press the Casters into the holes at the ends of each Star Base leg.

1

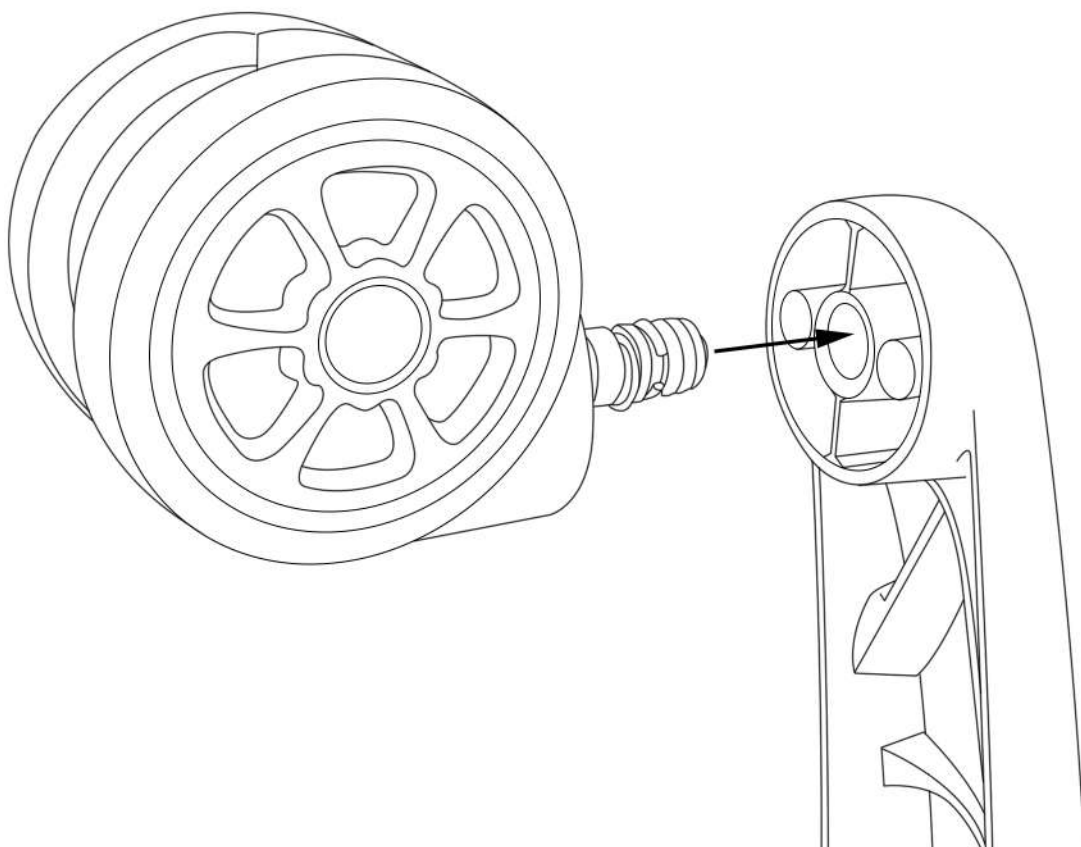

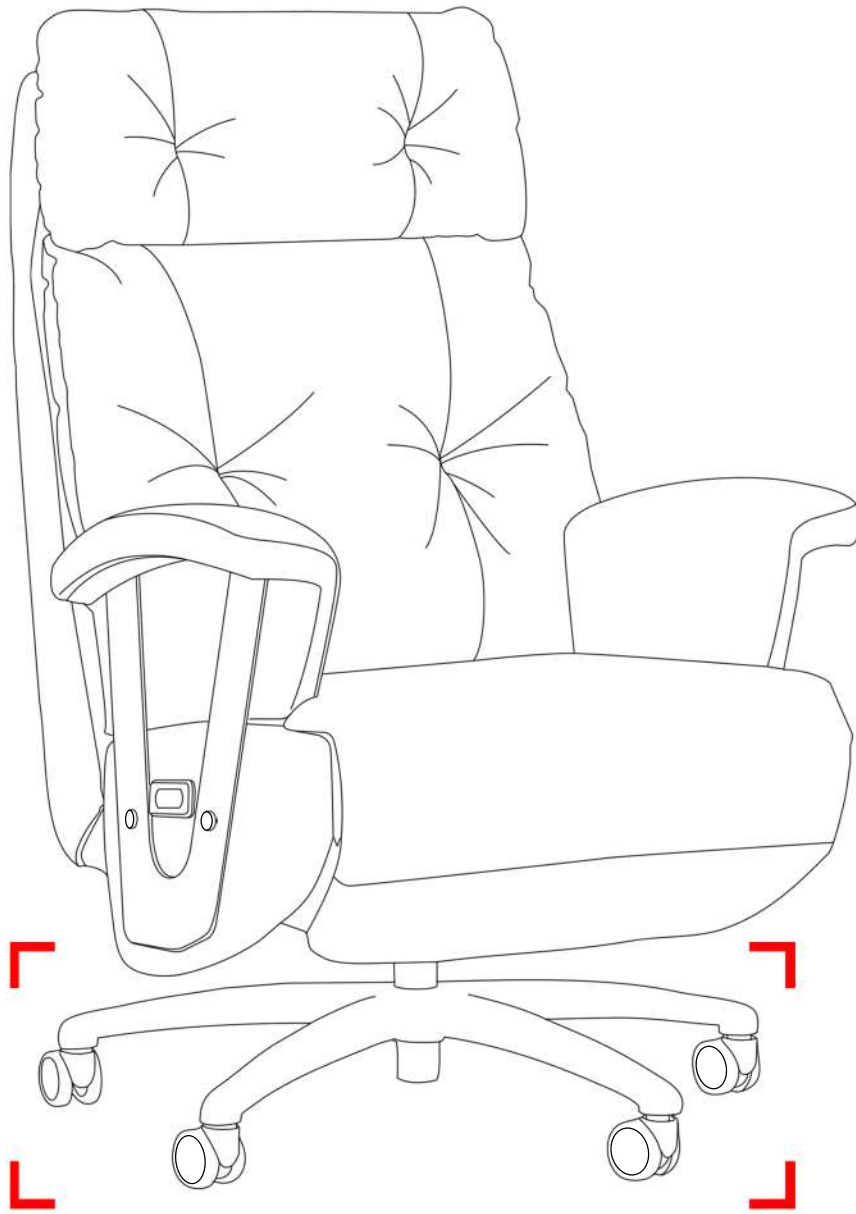

Insert the Gas Lift into the center hole of the Star Base.

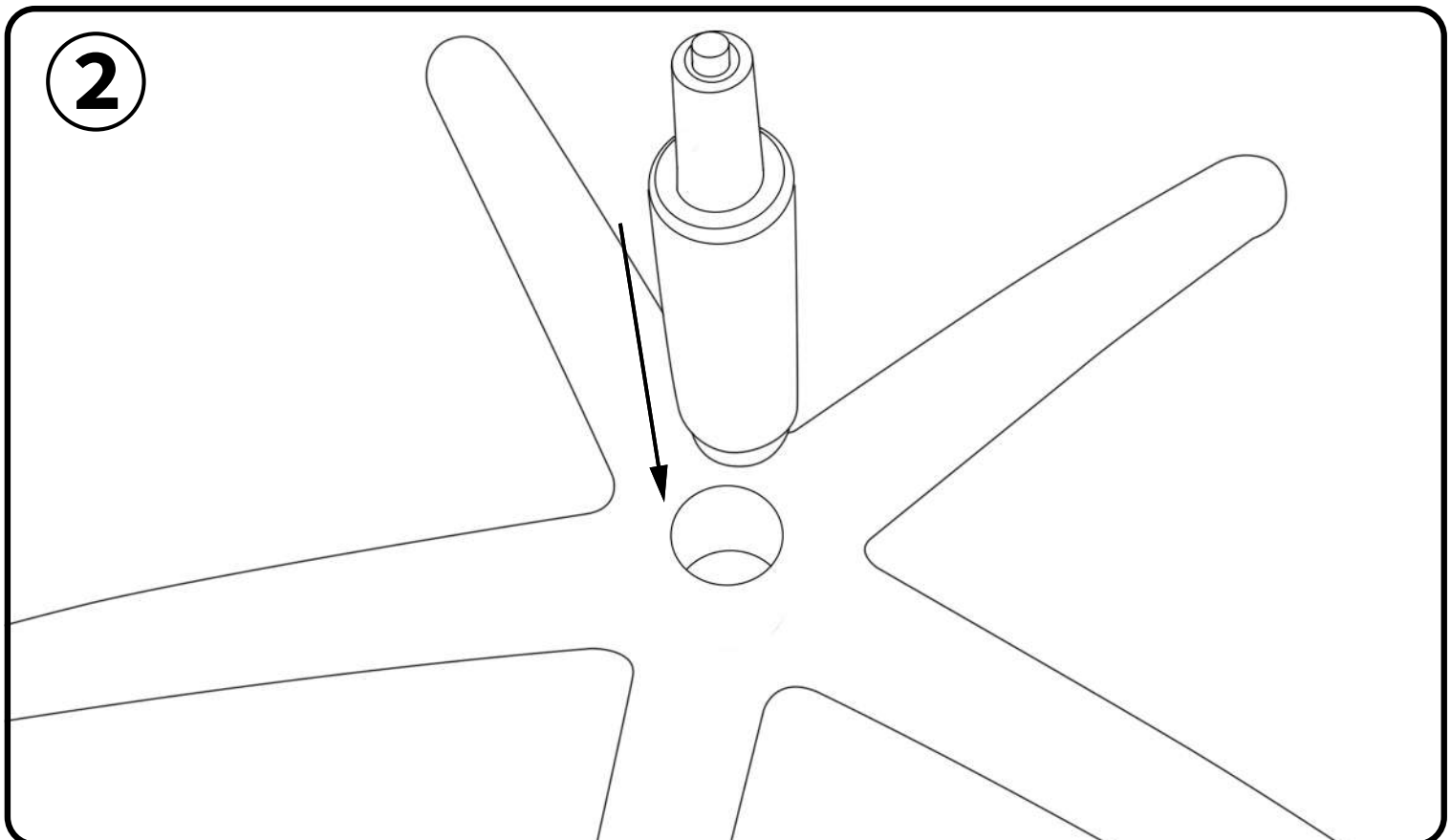

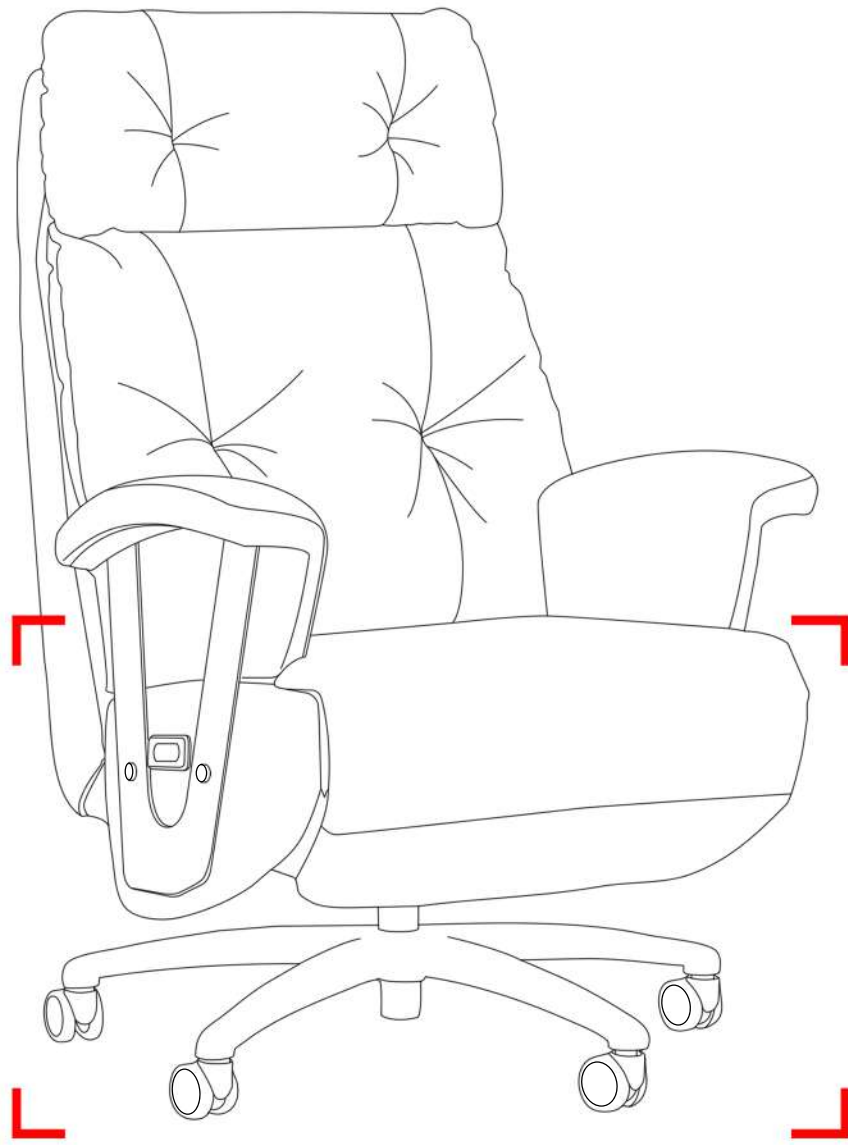

Pick up the Seat Cushion and align the center hole of the Seat Cushion board with the Gas Lift. Then, firmly place the Seat Cushion onto the Gas Lift until it connects securely.

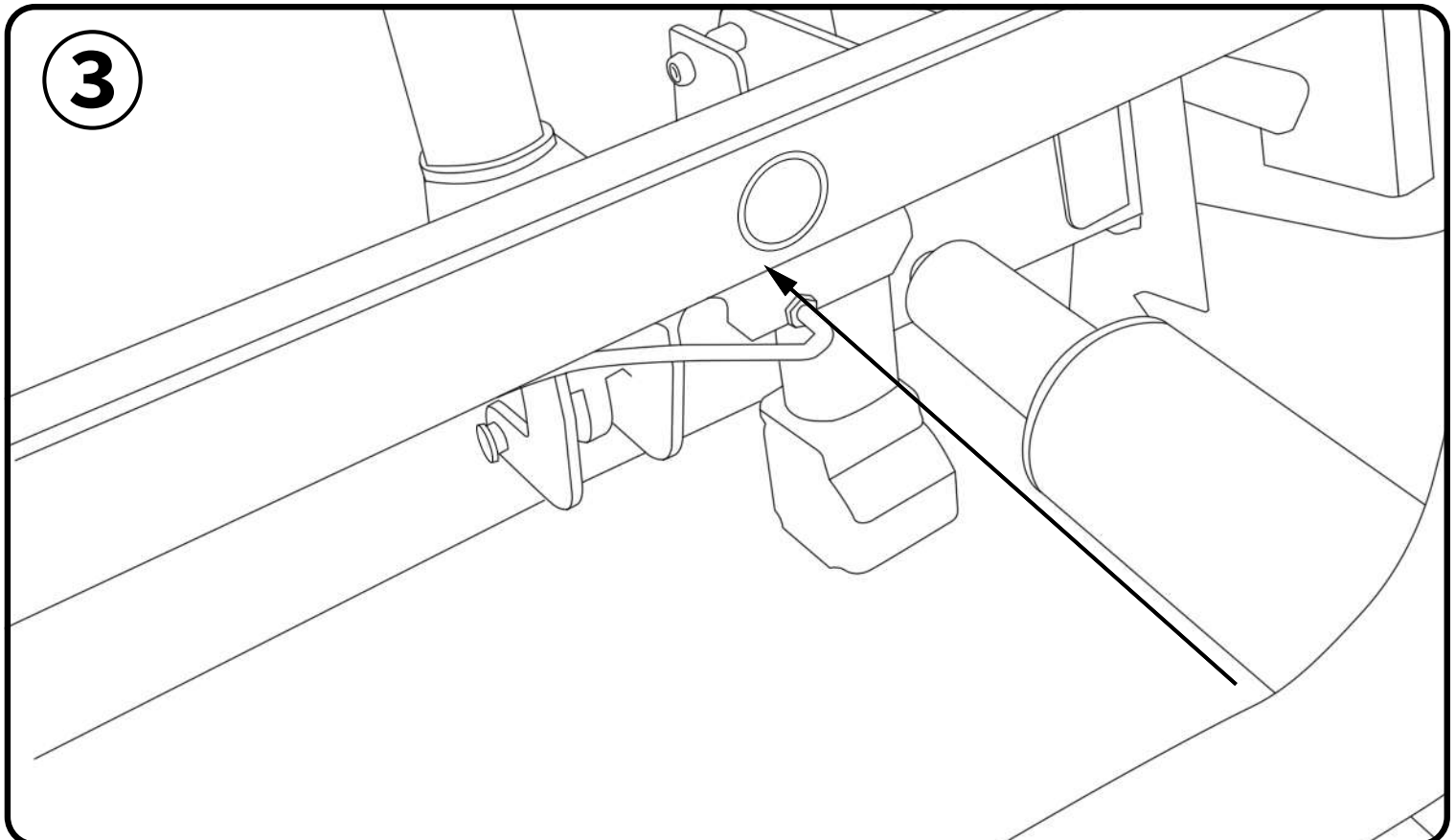

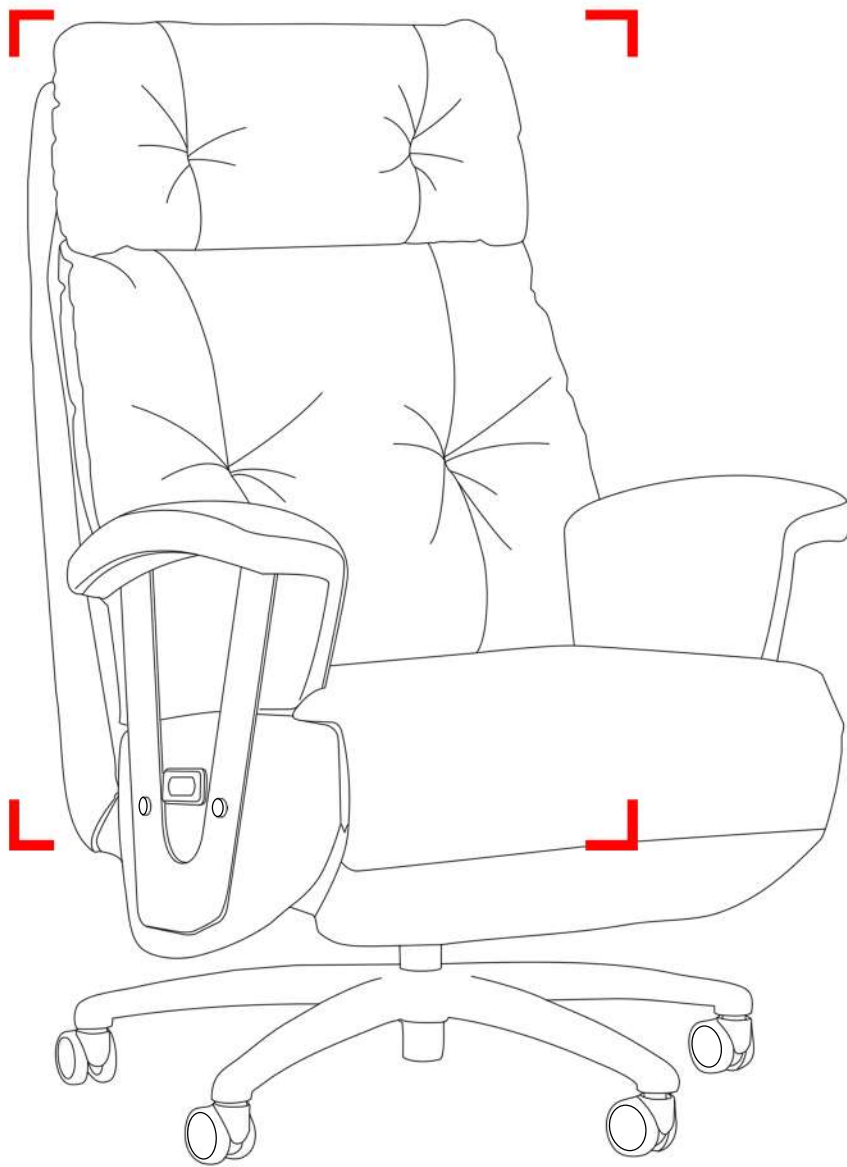

Hold the Back Cushion upright and insert the holes of the Back Cushion onto the metal plates on the side of the Seat Cushion until it is secure.

4

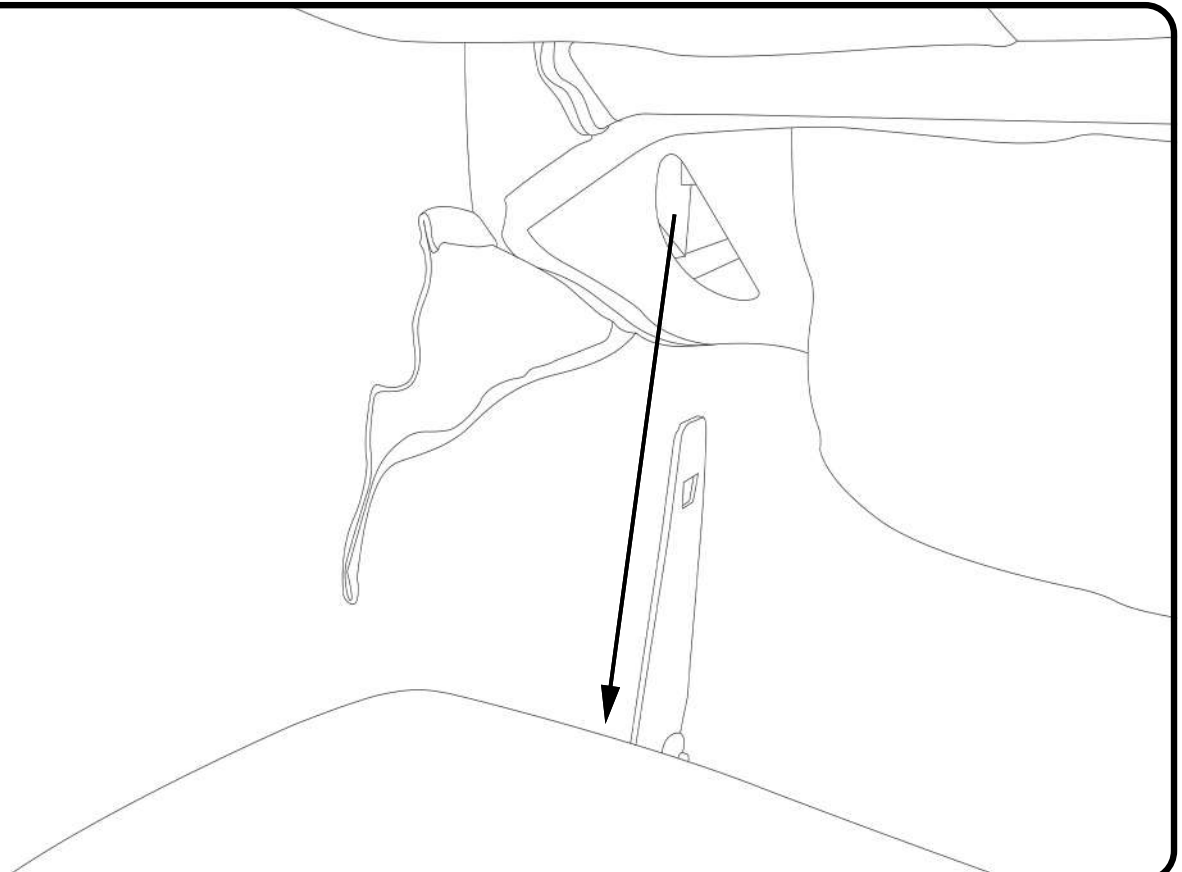

A low battery warning sound has been set to remind you to charge the chair. The charger is located in the black mesh pocket

underneath the chair's Back Cushion and typically takes about 3.5 hours to fully charge the battery. (please note: the new chair is in a low battery state).

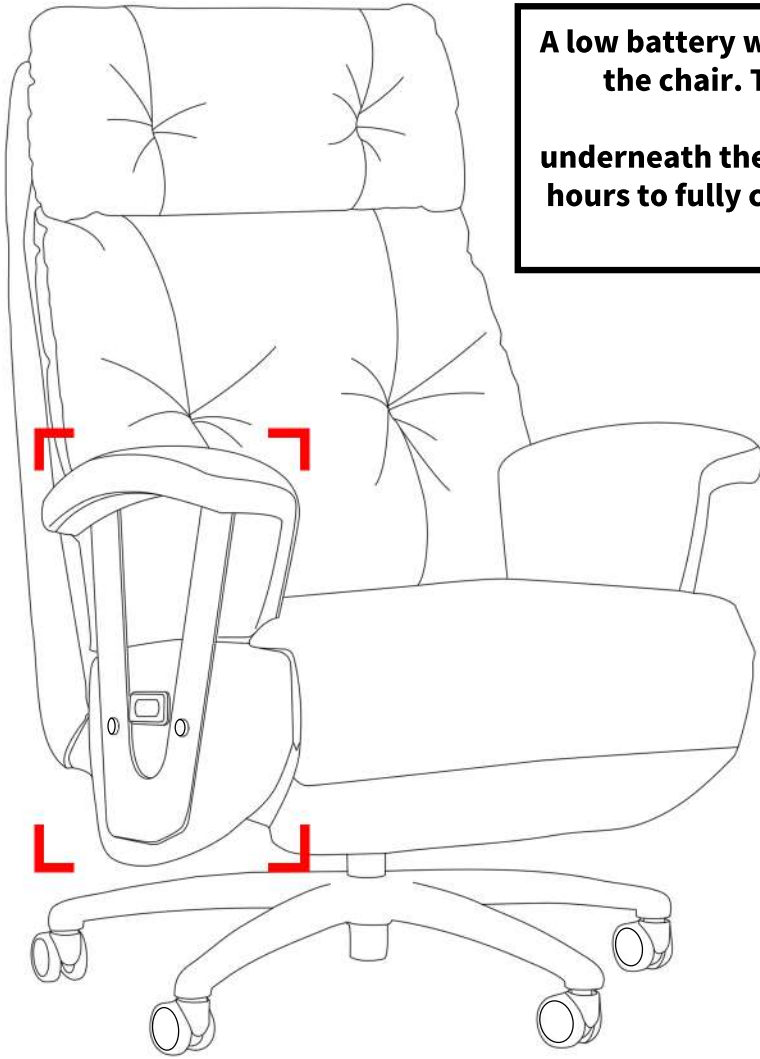

Use a wrench to attach the Arms to the Seat Cushion with four Bolts. Once the Bolts are secured, cover them with Plastic Caps for a neat appearance. Installation is complete.

5

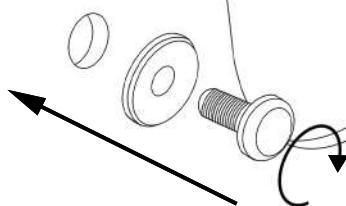

6

