

# USER MANUAL FOR MODEL# LJ-7896-RQZ

Thank you for purchasing our product.

For questions or assistance on assembly, parts or installation, please contact customer support:

Email: [service@jojospring.com](mailto:service@jojospring.com) Website: [www.jojospring.com](http://www.jojospring.com)

**Please note: We can only provide parts service when the original purchase orders can be identified.**

Please include the product number, order number, and your phone number in the email.

If there are broken or missing parts, please include the part numbers and quantities, and your address. We will ship you the replacement parts.

All emails will be answered within 24 hours.

For hard to explain problems, please send us a few pictures showing the problems if you can.

We involve the factory technicians directly in the support, so you can be assured you will deal with the experts.

## CAUTION

1. Rated 110~130V/60Hz, bulb E26 13W maximum, G9 LED 3W maximum.
2. Care should be taken to avoid damage to the surface of lighting and wire. Wearing gloves are recommended when installing.
3. Keep lighting away from acid, alkali and other corrosive chemical or gas, clean the lighting with clean soft cloth only.
4. Installation must be carried out by qualified electrician only.
5. Disconnect the power before installing, cleaning and replacing lighting.
6. Never cover the lighting when power is connected.



**Assembly Video on YouTube:**

<https://youtu.be/h89u1x84Cew>

Or search on YouTube (including the quotation marks): "LJ-7896-RQZ"

## MISE EN GARDE

1. Évalué 110 ~ 130V / 60Hz, ampoule E26 13W maximum, G9 LED 3W maximum.
2. Des précautions doivent être prises pour éviter d'endommager la surface de l'éclairage et du fil. Le port de gants est recommandé lors de l'installation.
3. Gardez l'éclairage éloigné de l'acide, des alcalis et d'autres produits chimiques ou gaz corrosifs, nettoyez l'éclairage uniquement avec un chiffon doux et propre.
4. L'installation doit être effectuée uniquement par un électricien qualifié.
5. Débranchez l'alimentation avant d'installer, de nettoyer et de remplacer l'éclairage.
6. Ne couvrez jamais l'éclairage lorsque l'alimentation est connectée.

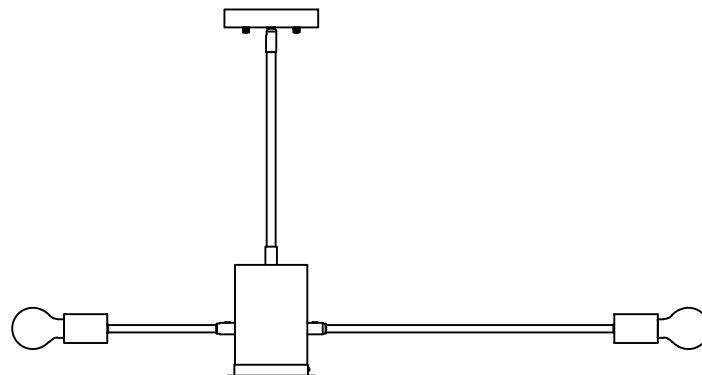

The wiring connection of luminaire and outlet box

There are two main wires. One is in black and the other is in white. Be sure to connect, the black wire (positive electrode) to the outlet box wire (positive electrode), the white wire (negative electrode) to the outlet box wire (negative electrode) and the copper fixture ground wire to the supply ground wire with wire connectors.

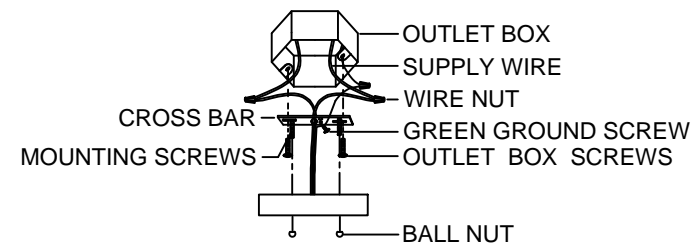

Ten (10) 13-watt (E26) LED bulbs (not included)

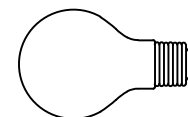

One 3-watt (G9) LED bulb (not included)



# INSTRUCTION

3/17/2022

- 4A. Lock the crossbar on the junction box of the ceiling by using 2 pcs of 5/32 screws in the accessories bag.  
 4B. Connect the wires. The black wire is the hot /positive ( + ) wire.  
 The white wire is the negative ( - ) wire.  
 4C. Cover the ceiling canopy and attach the screws to the canopy.

3. Connect three 12 inches rods and one 6 inches rod together. Attach one end to part #5, attach the other end to part #2.





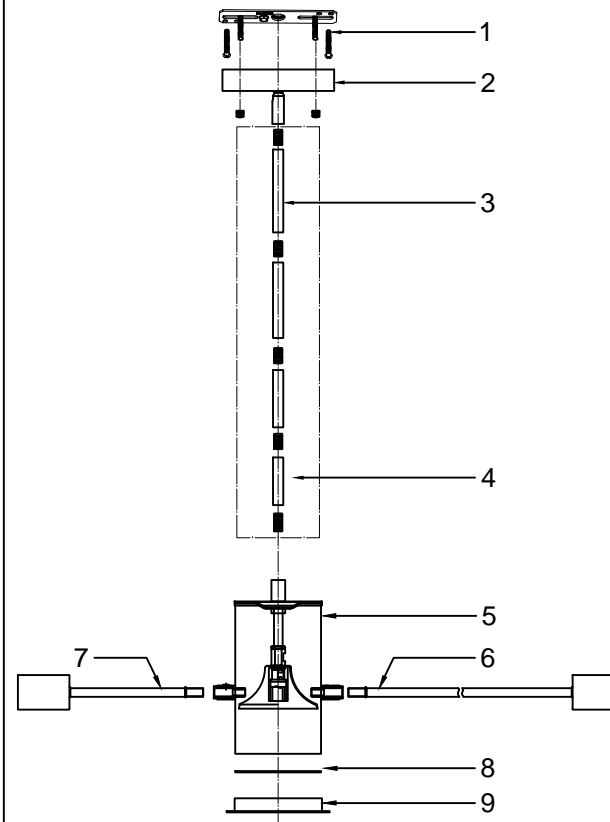
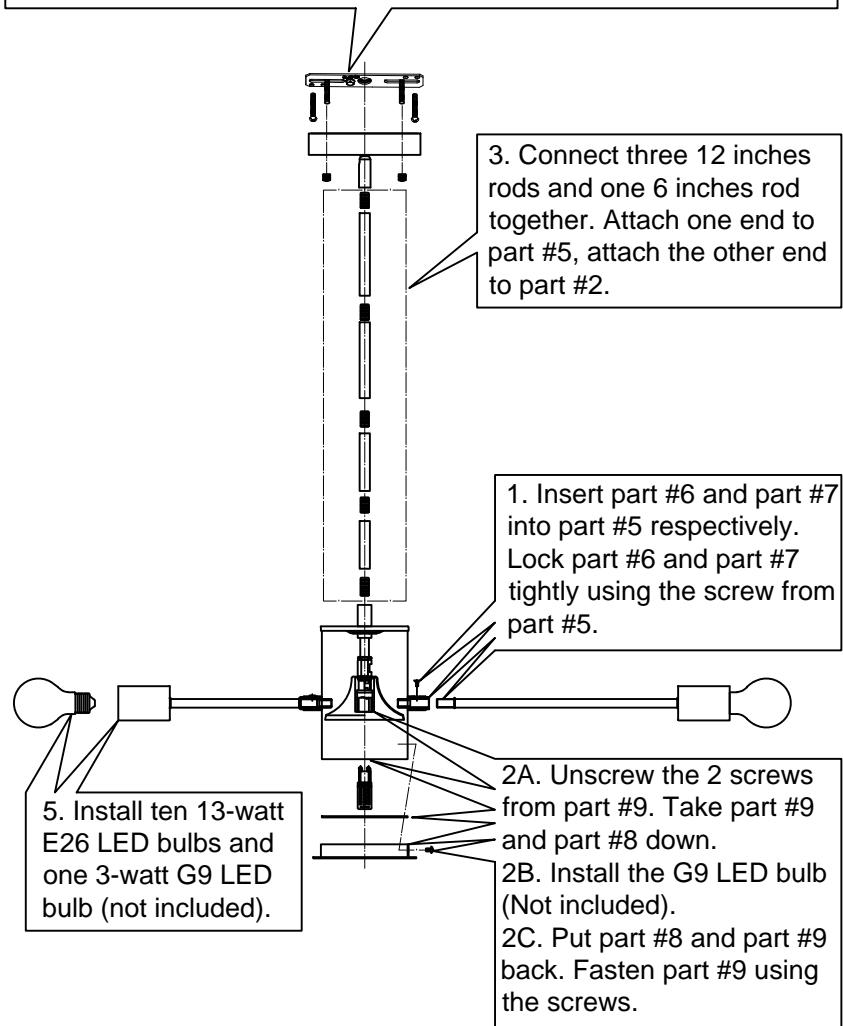

1. Insert part #6 and part #7 into part #5 respectively. Lock part #6 and part #7 tightly using the screw from part #5.

5. Install ten 13-watt E26 LED bulbs and one 3-watt G9 LED bulb (not included).

- 2A. Unscrew the 2 screws from part #9. Take part #9 and part #8 down.  
 2B. Install the G9 LED bulb (Not included).  
 2C. Put part #8 and part #9 back. Fasten part #9 using the screws.

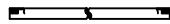
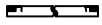
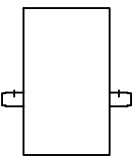
Please note: The parts in this table are completely unassembled, for illustrative purpose. In the actual product that you receive, some parts are assembled and attached together.

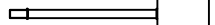
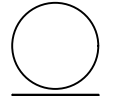
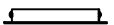

| Part Number | Picture   | Quantity |
|-------------|---|----------|
| 1           |    | 1        |
| 2           |    | 1        |
| 3           |    | 3        |
| 4           |    | 1        |
| 5           |   | 1        |
| 6           |  | 5        |
| 7           |  | 5        |
| 8           |  | 1        |
| 9           |  | 1        |
| spare parts |  | 2        |
|             |  | 3        |