

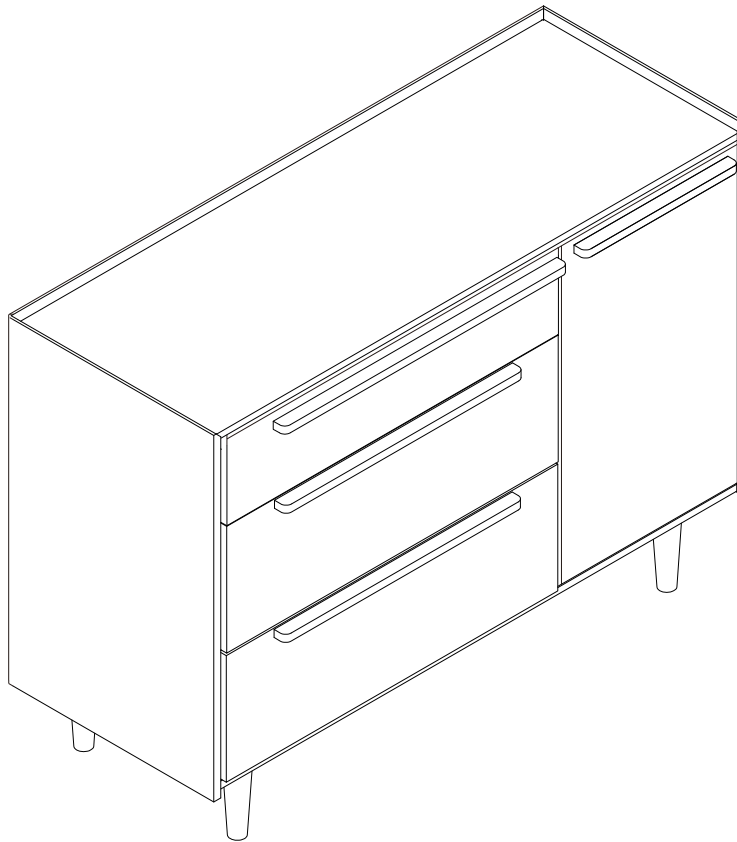

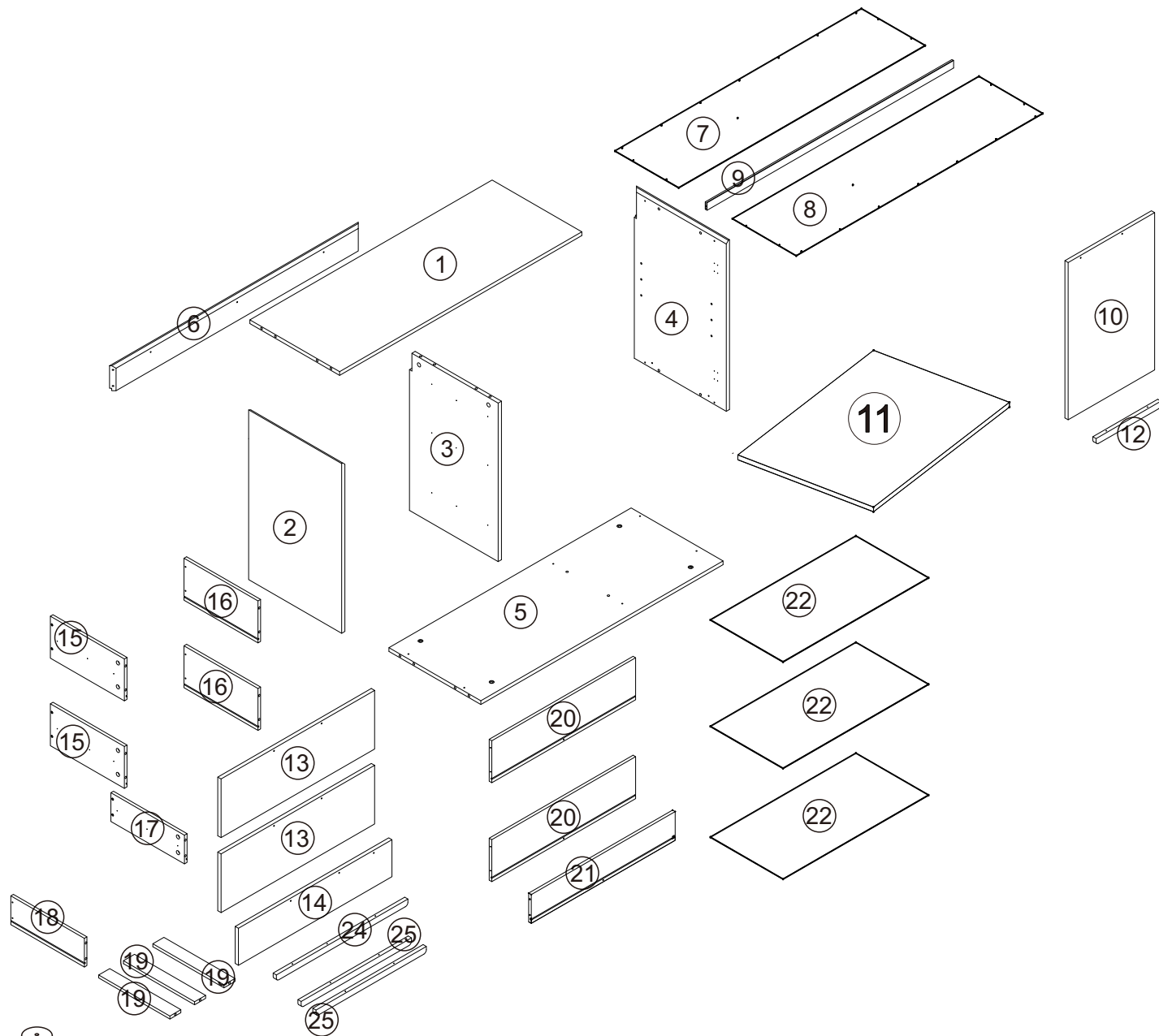









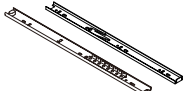

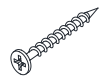



# ASSEMBLY INSTRUCTION



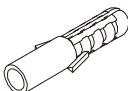

## Dresser



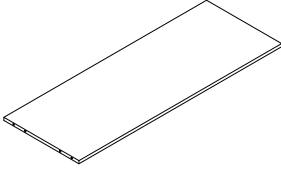
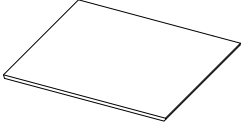
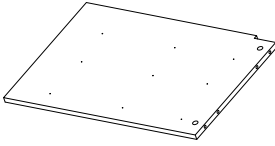
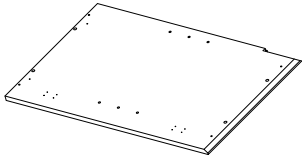
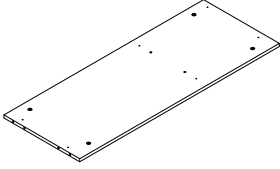
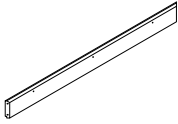
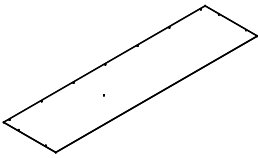
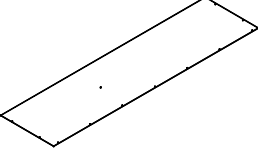
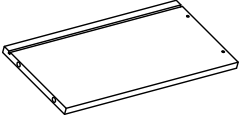
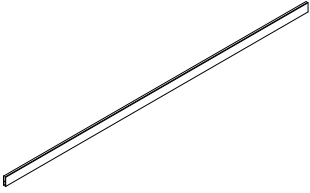
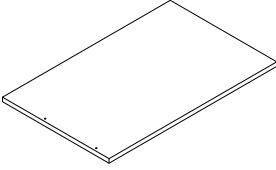
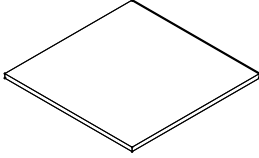
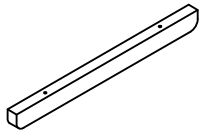
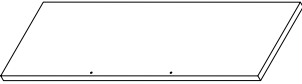
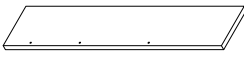
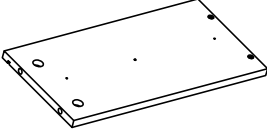
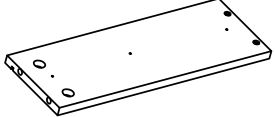
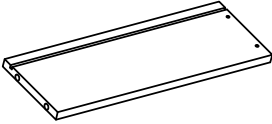
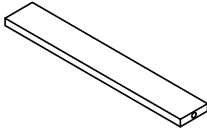
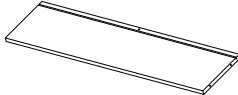

 23 x4

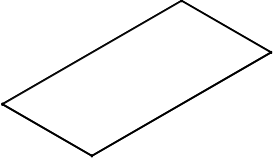
				
Ax25	Bx56	Cx6	Dx12	Ex25
				
Fx28	Gx4	Hx24	Ix2	Jx4
				
Kx12	Lx2	Mx5	Nx2	Ox1
				
Px62	Qx4	Rx4	Sx2	Tx1

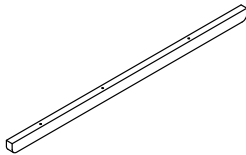
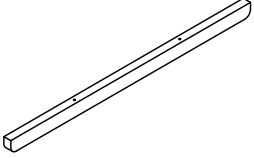
 ① X1	 ② X1	 ③ X1	 ④ X1	
 ⑤ X1	 ⑥ X1	 ⑦ X1	 ⑧ X1	 ⑯ X2
 ⑨ X1	 ⑩ X1	 ⑪ X1	 ⑫ X1	
 ⑬ X2	 ⑭ X1	 ⑮ X2	 ⑰ X1	
 ⑱ X1	 ⑲ X3	 ⑳ X2	 ㉑ X1	
 ㉒ X3	 ㉓ X4	 ㉔ X1	 ㉕ X2	

# step 1

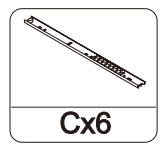
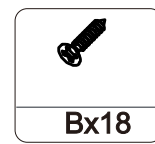
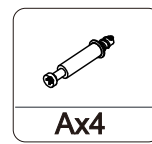
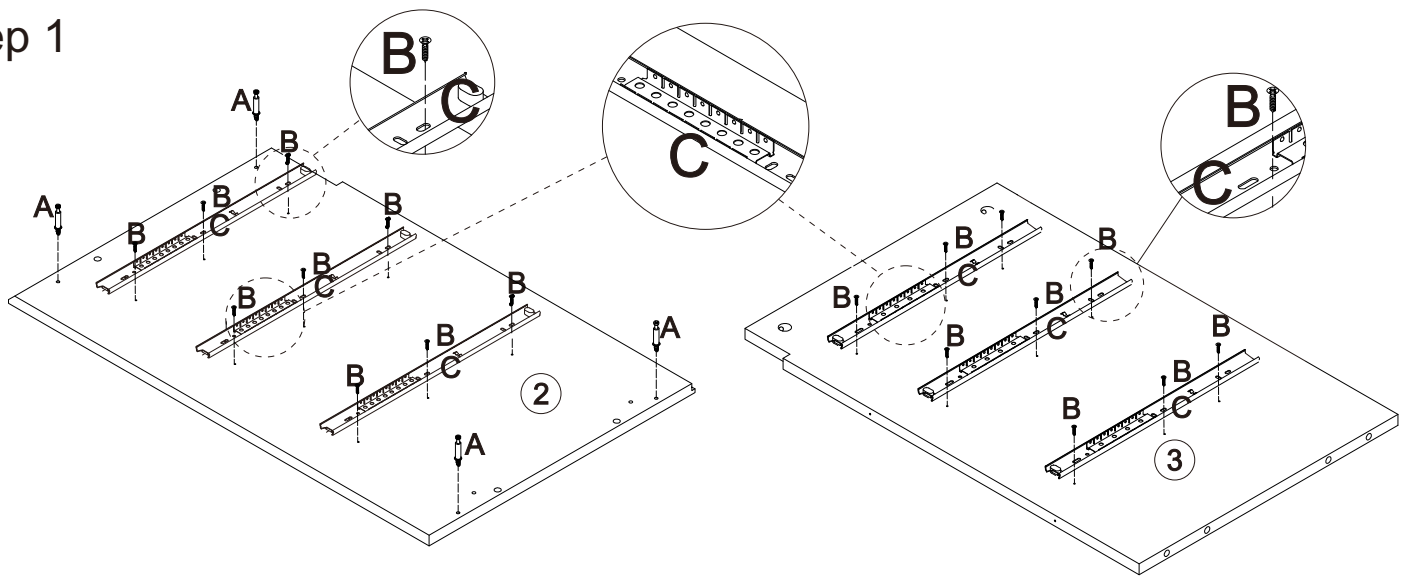

# step 2

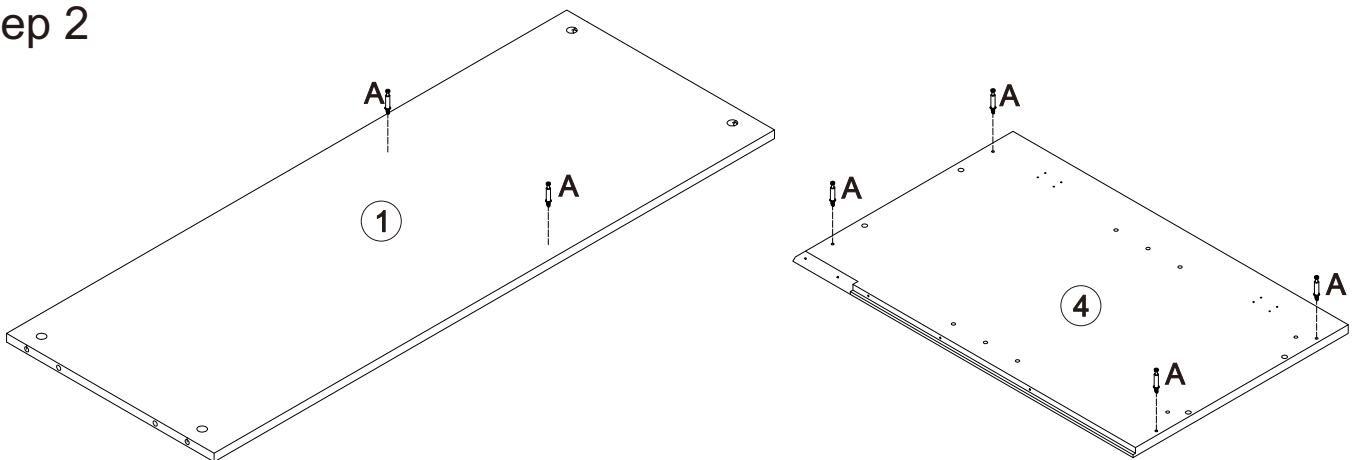

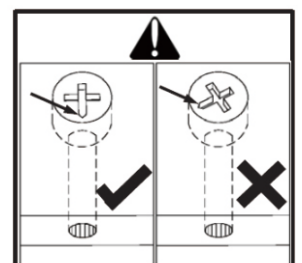
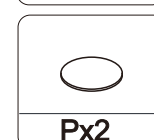
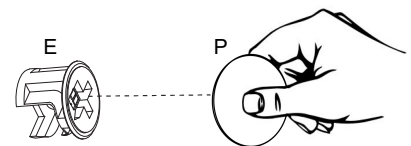
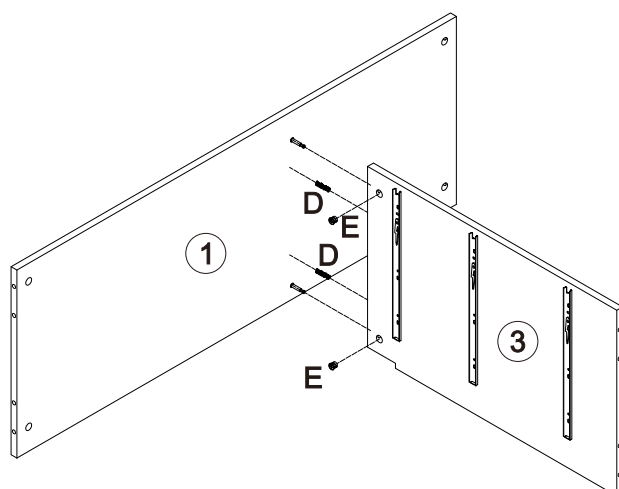

# step 3



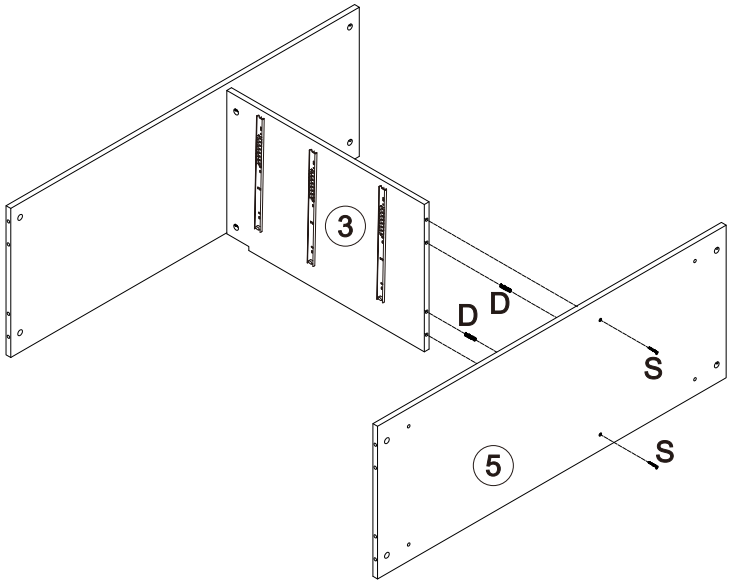

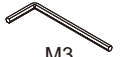

# step 4

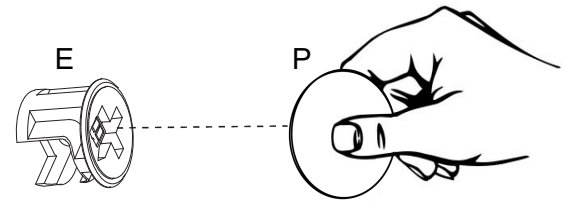
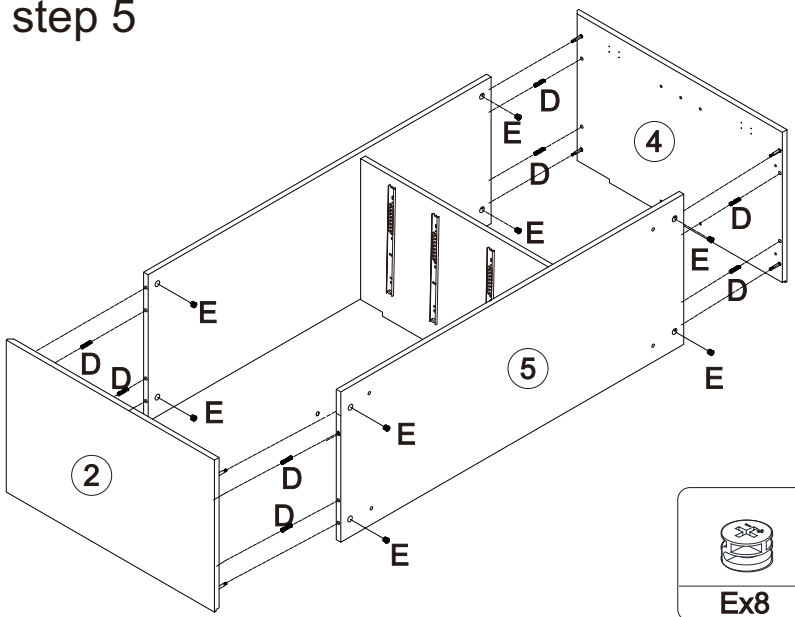

-   
**Dx2**
-   
**Px2**
-   
**Sx4**
-   
**M3 Tx1**



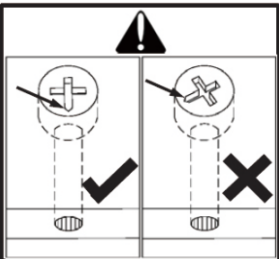

# step 5

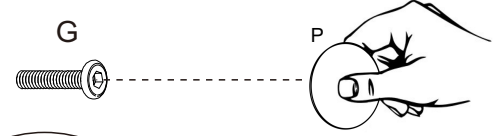
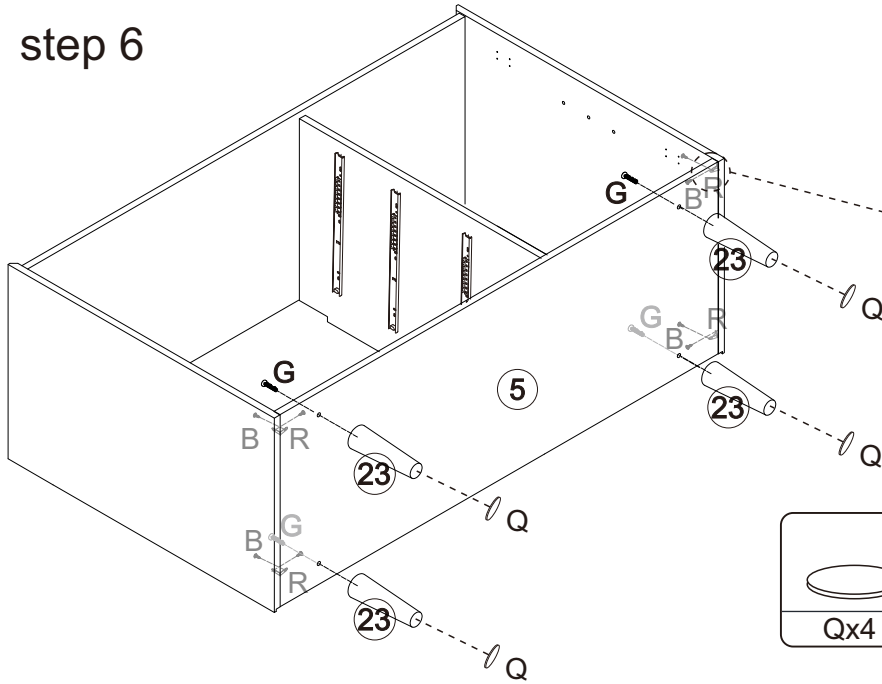

-   
**Dx8**
-   
**Ex8**
-   
**Px8**
- 

# step 6

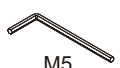

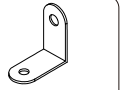
-   
**Bx8**
-   
**Gx4**
-   
**Qx4**
-   
**M5 Ox1**
-   
**Px4**
-   
**Rx4**

step 7

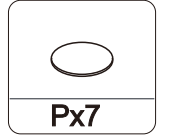
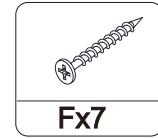
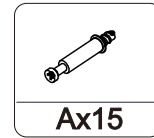
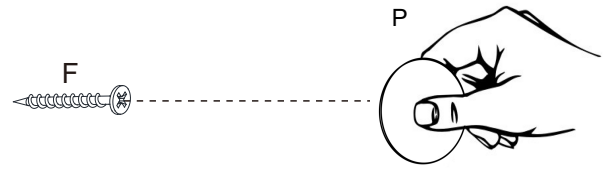
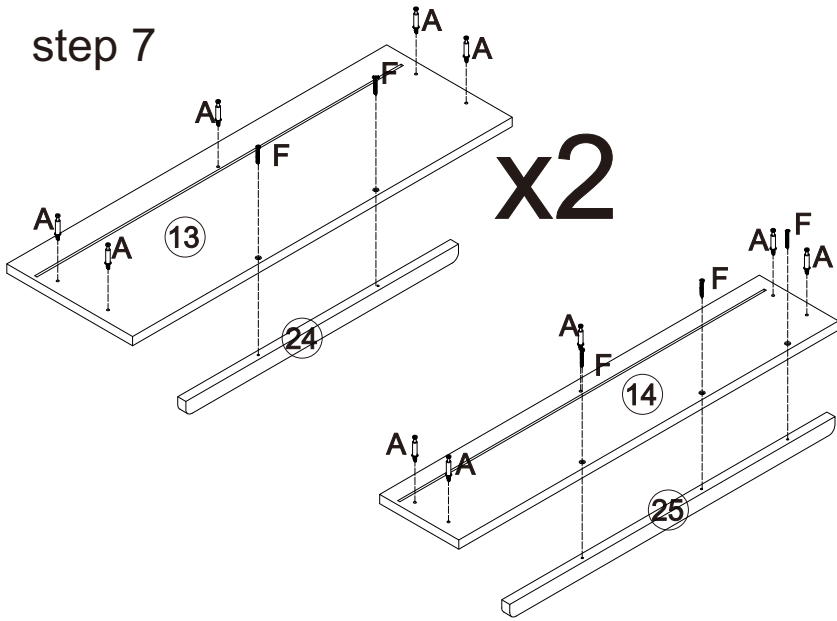

step 8

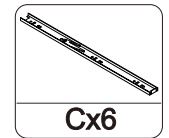
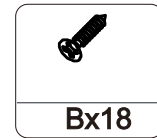
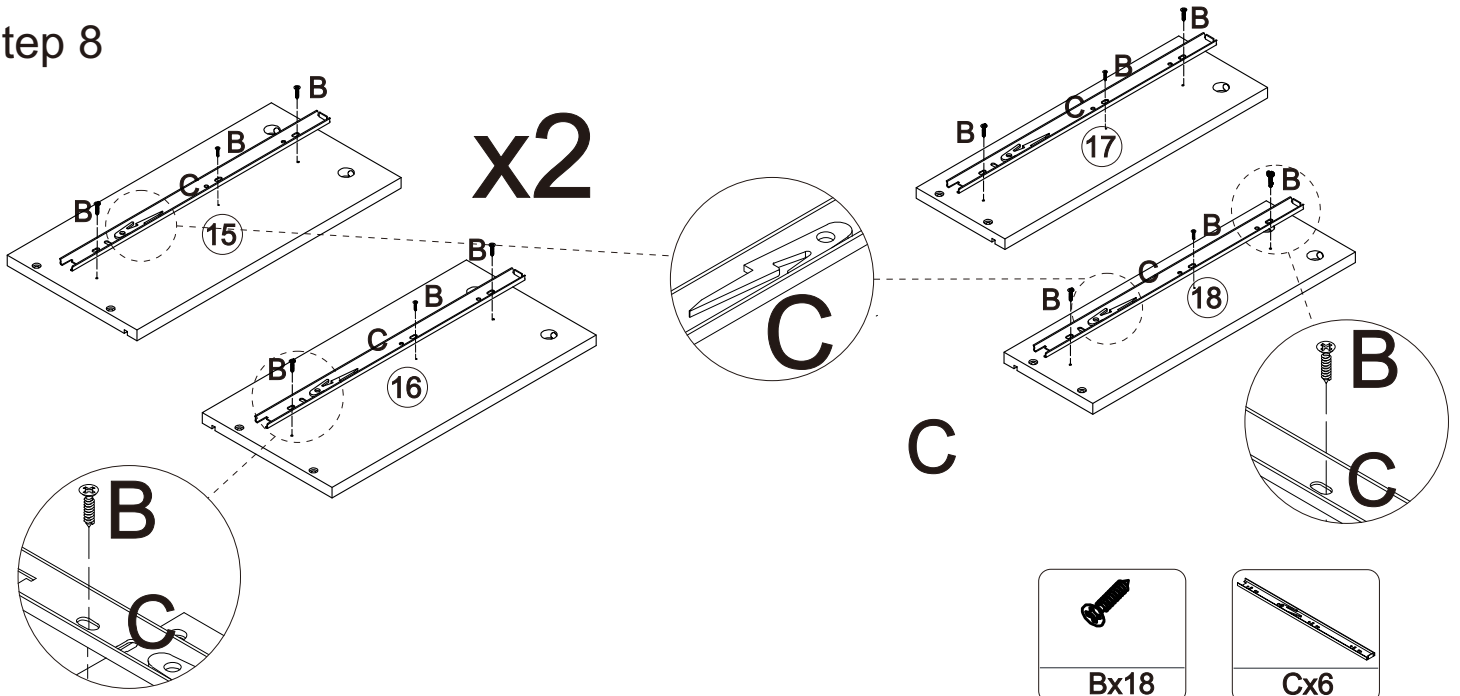

step 9

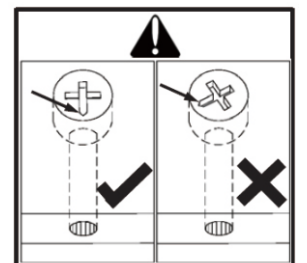
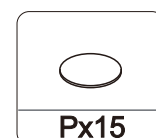
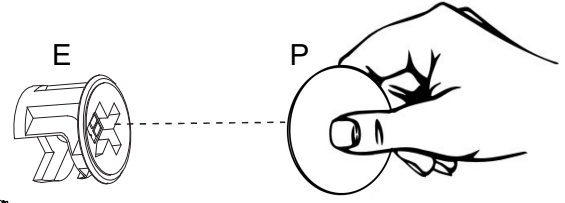
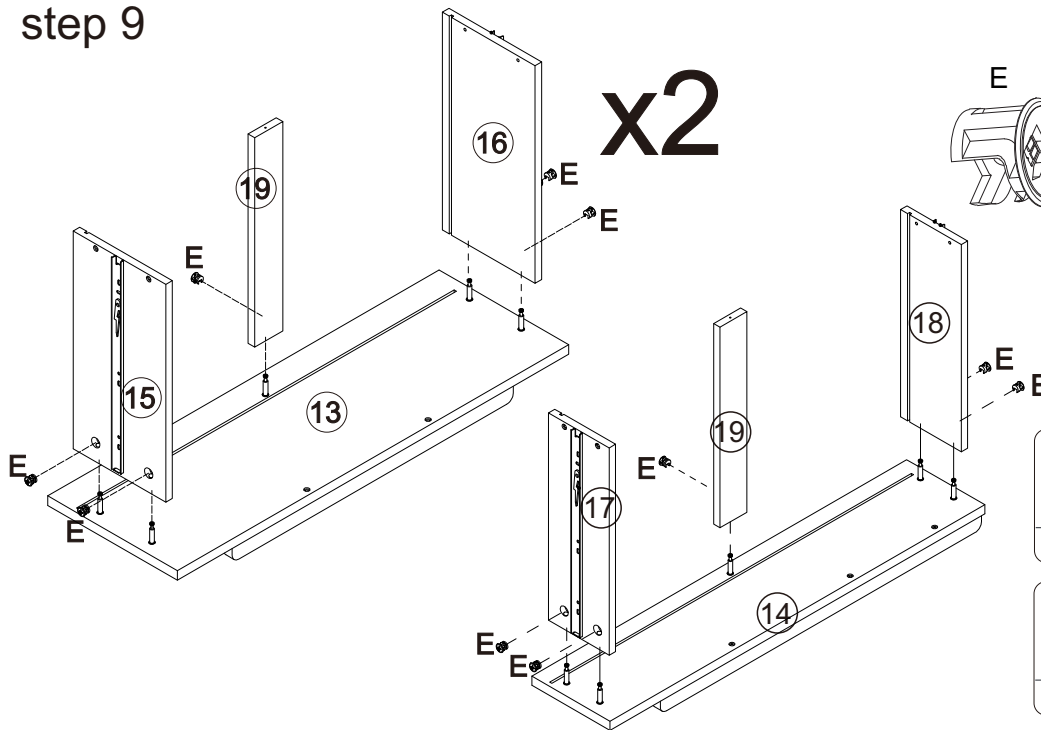

step 10

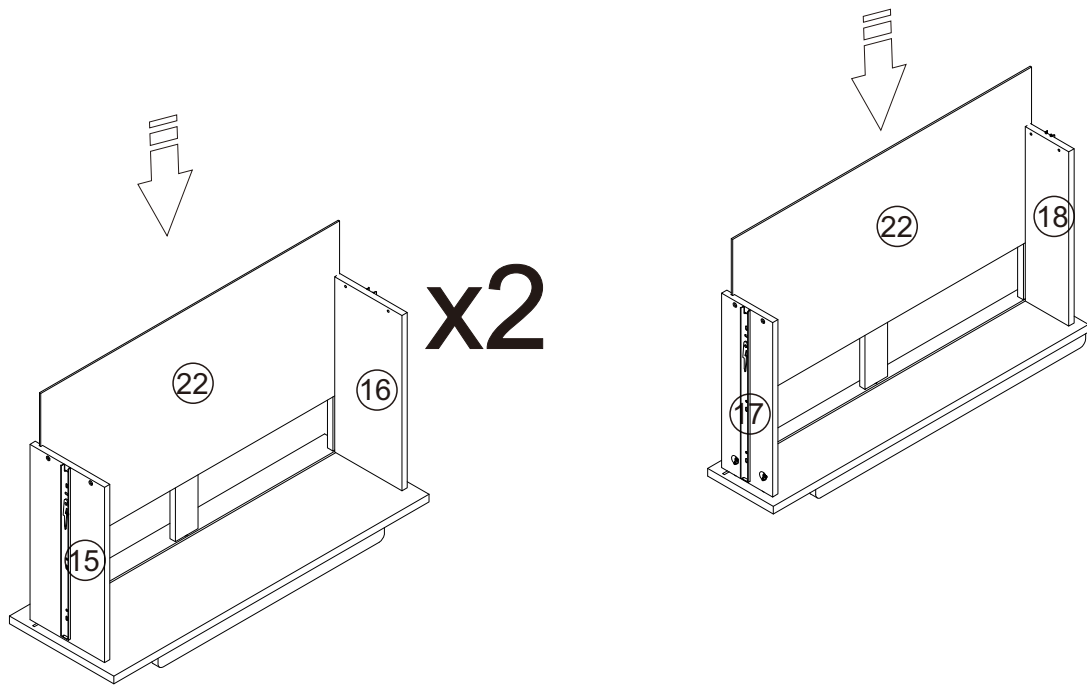

step 11

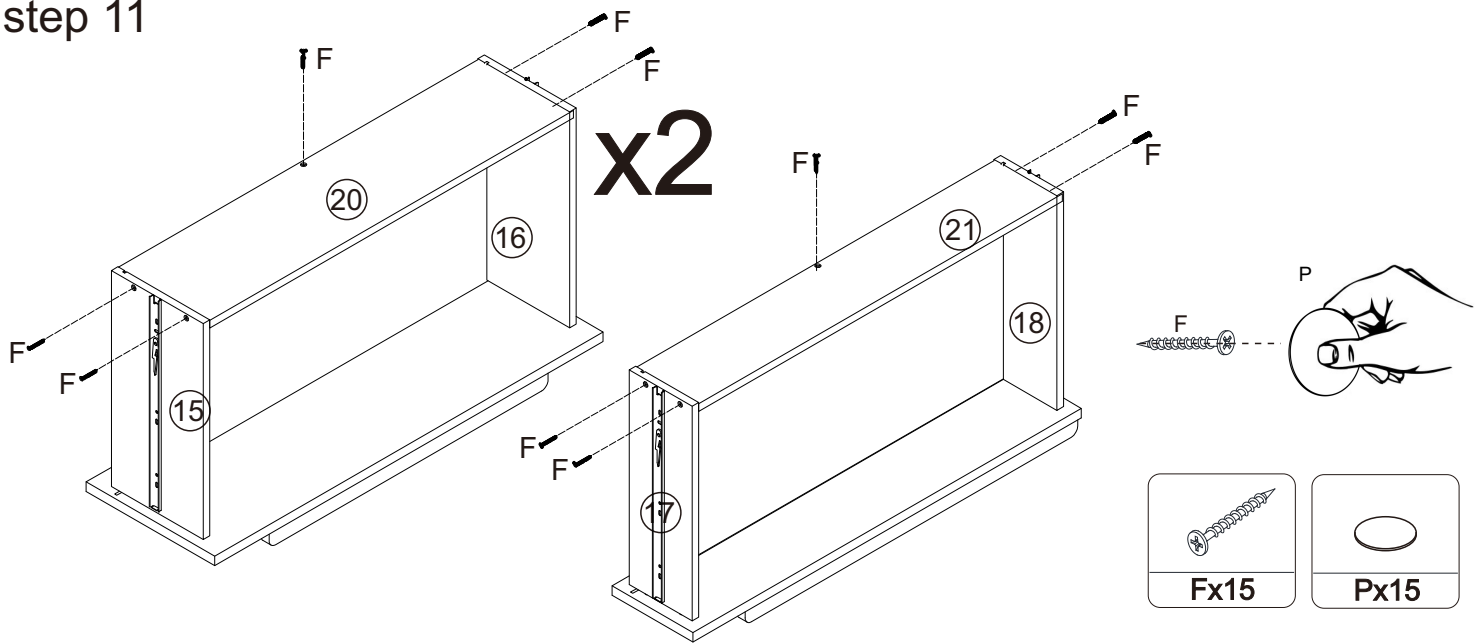

step 12

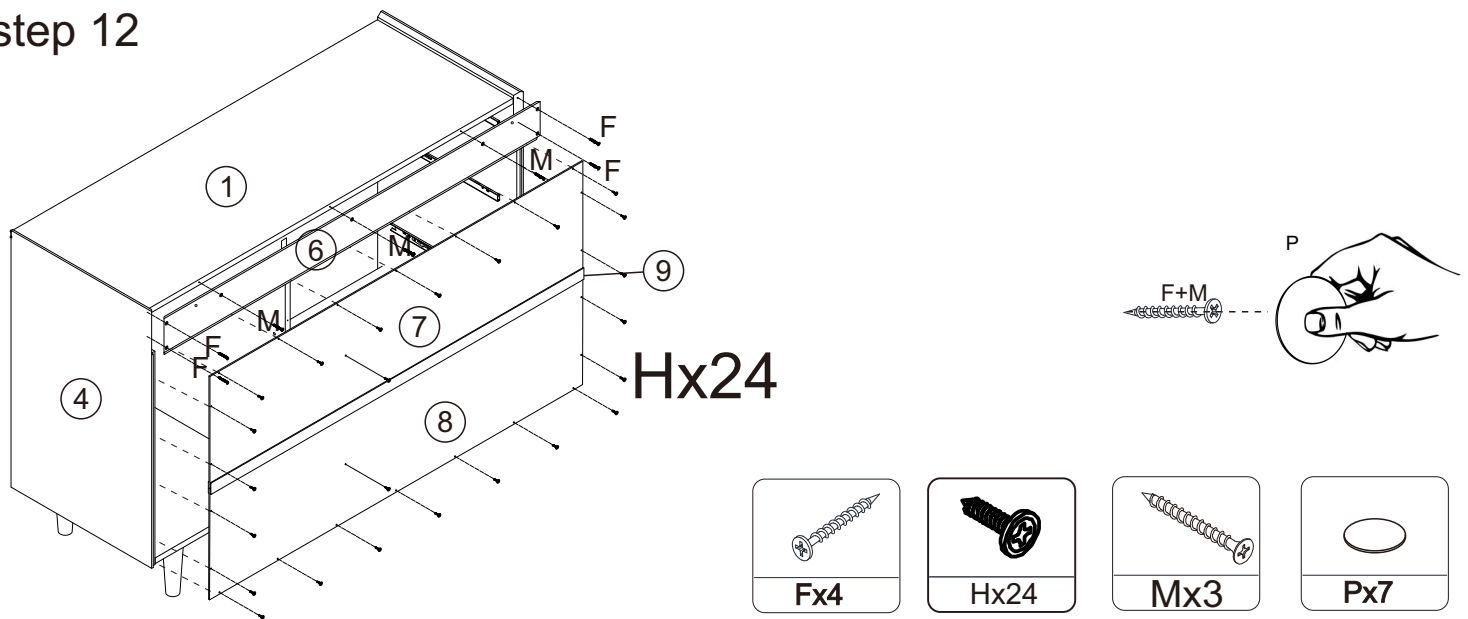

# step 13

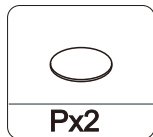
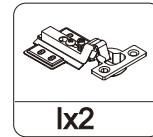
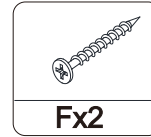
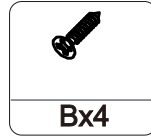
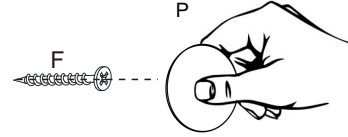
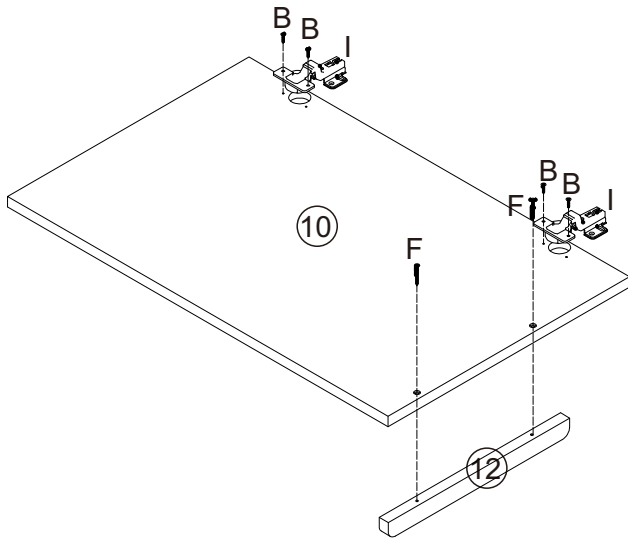

# step 14

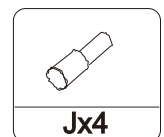
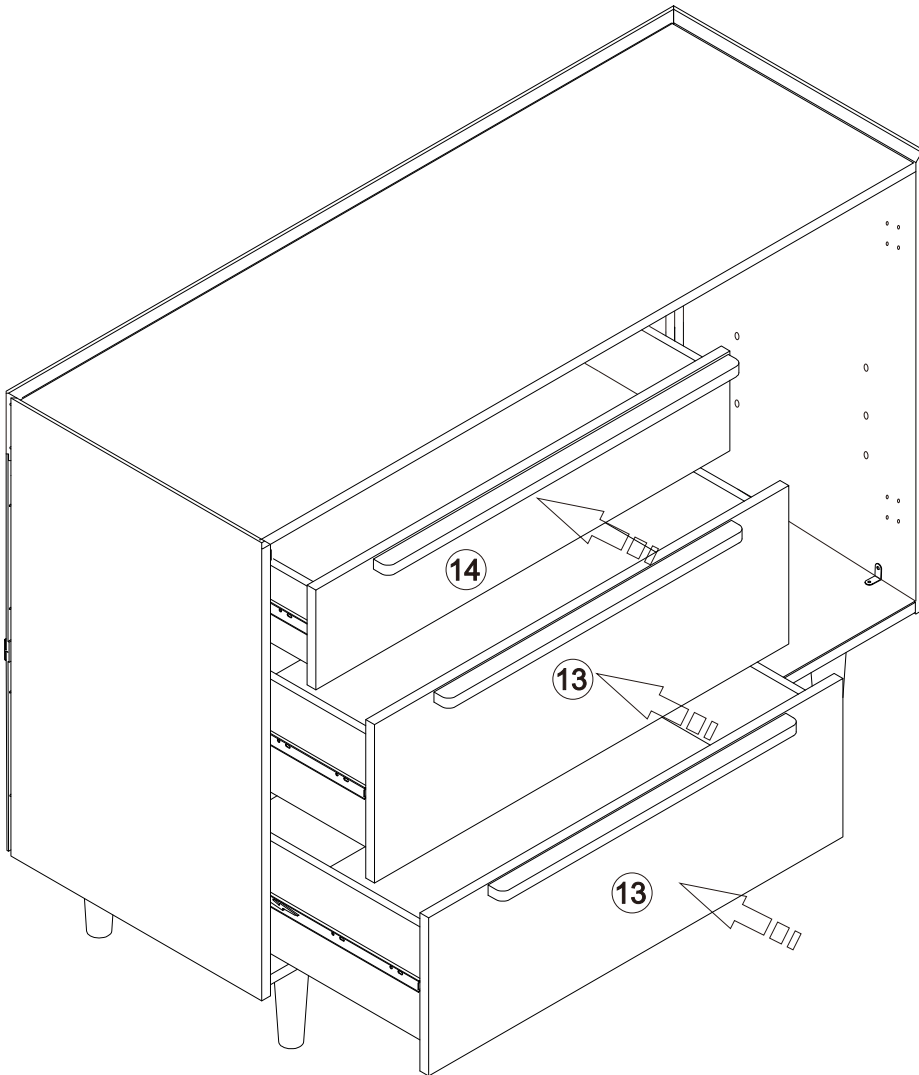

# step 15

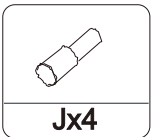
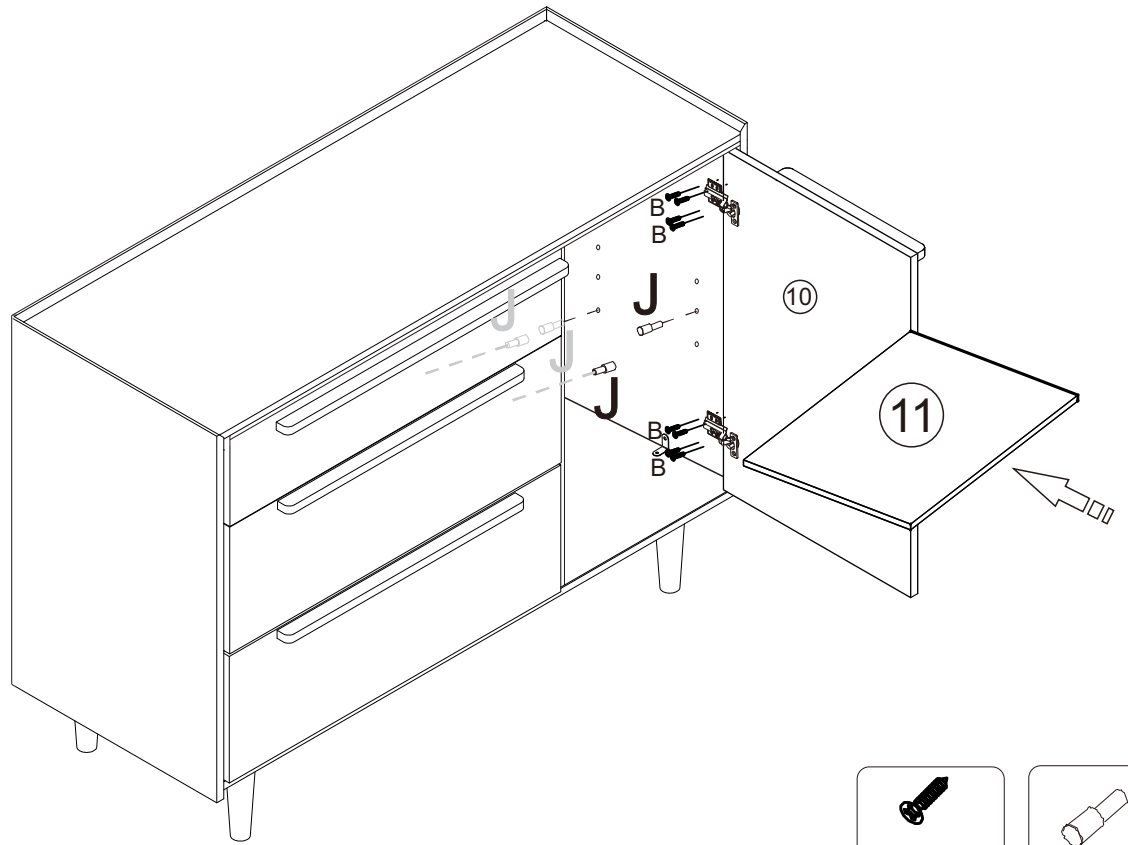

# step 16

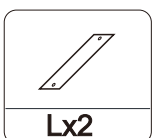
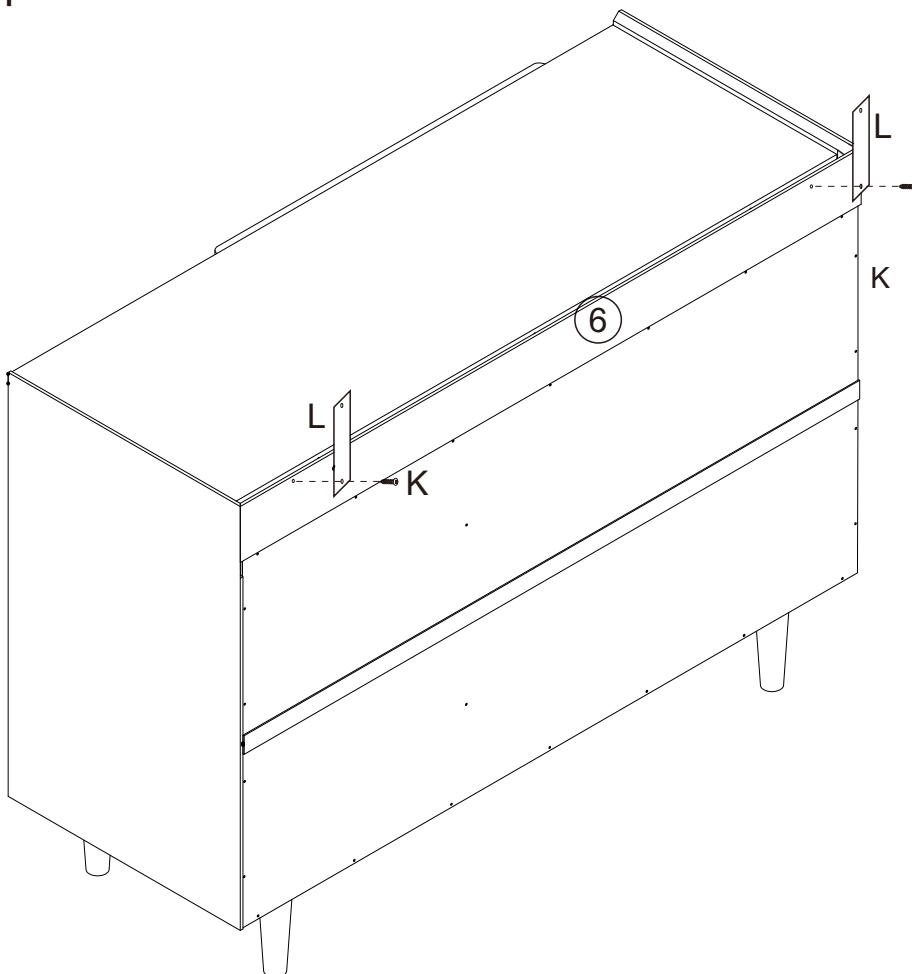

step 17

