

ASSEMBLY INSTRUCTION

Friendly Reminder:

- 1.This sofa is packed in 4 boxes. Please assemble it After all boxes are received.
- 2.As the cushions are all vacuum compressed,there will be some wrinkles. Please give your cushions up to 72 hours to reach its original size and the wrinkles will basically dissapper.
- 3.Please do not open the compressed packages until your sofa frame is complete

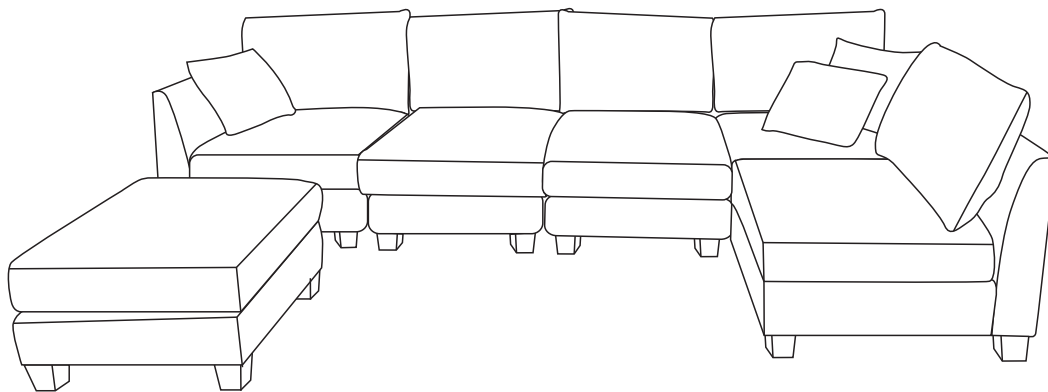



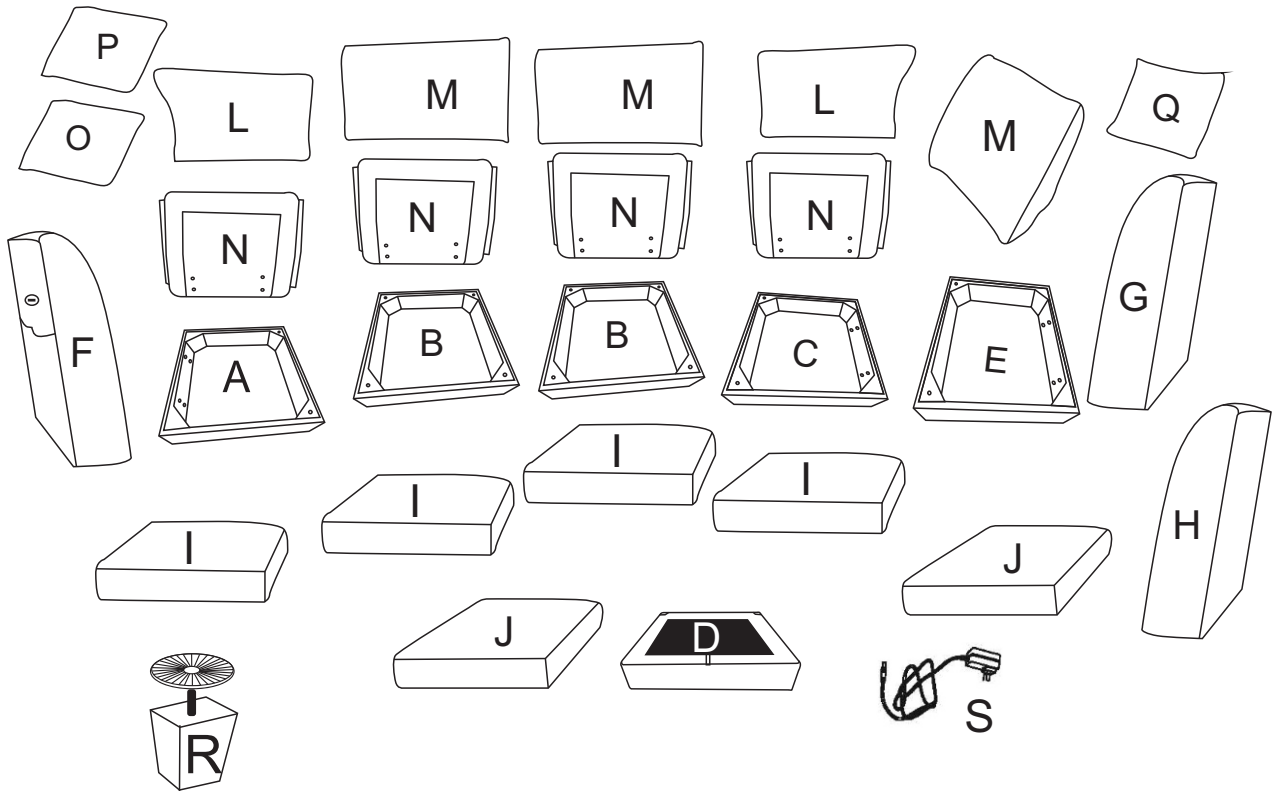

Return & Warranty policy:

- We strive to offer the highest quality products,and we also try our best to satisfy each and every customer that orders from us with replacement parts or service as needed.
- If the item is damaged or defective, please take photos as evidence for replacements and refunds.
- Please do not return to store,contact the seller if you have any troubles with this product.

All parts and hardwares

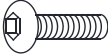

Hardware Package

- | | | | | | |
|---|---|--------------------|---|--|---------------|
| 1 |  | 28x Screws M8x35mm | 2 |  | 28x Washer |
| 3 |  | 4x Screws M6x14mm | 4 |  | 2x Angle iron |
| 5 |  | 1x Washer | | | |

NOTE: Take out of all parts from 4 boxes, make sure all parts you have received before assembled.

COMPONENTS

BOX 1

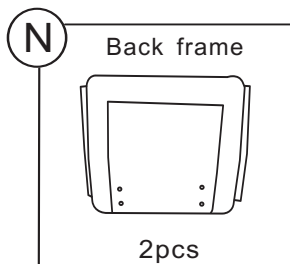
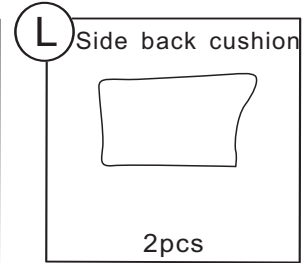
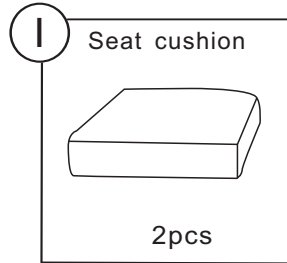
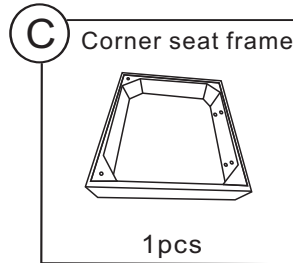
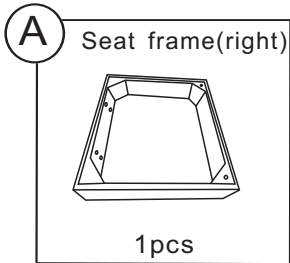

BOX 2

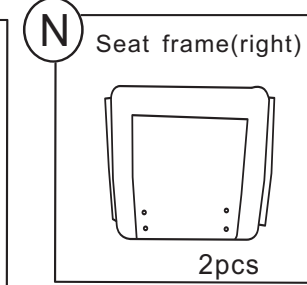
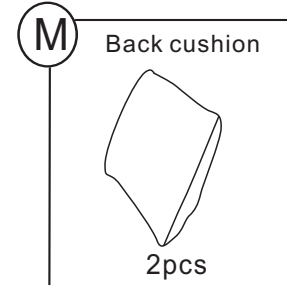
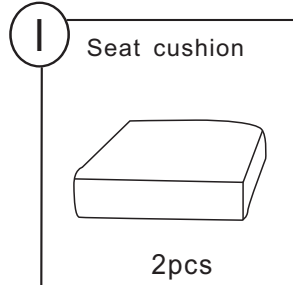
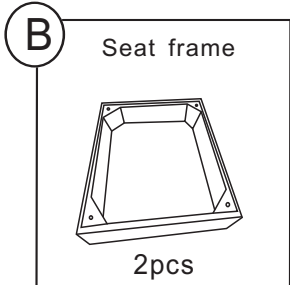

COMPONENTS

BOX 3

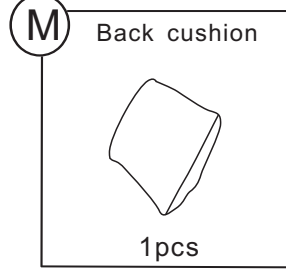
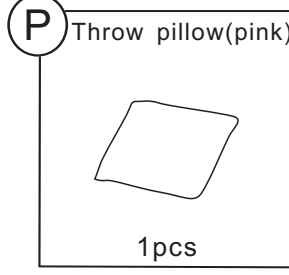
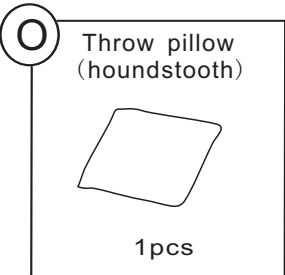
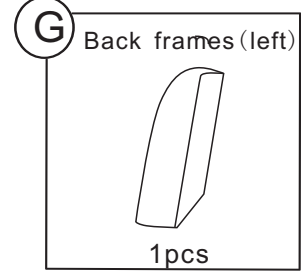
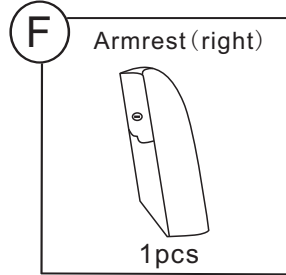
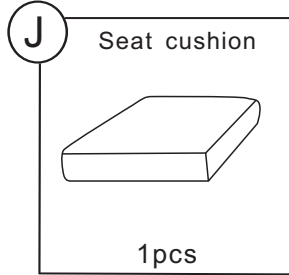
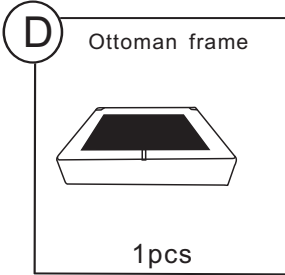

BOX 4

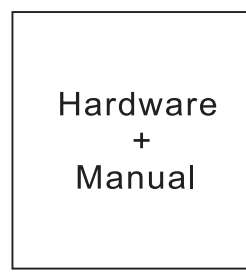
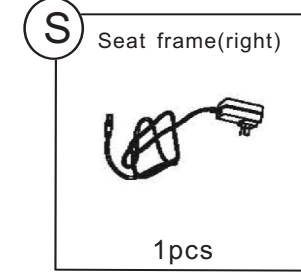
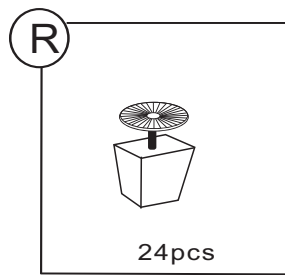
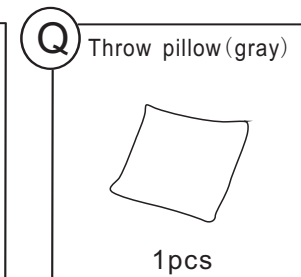
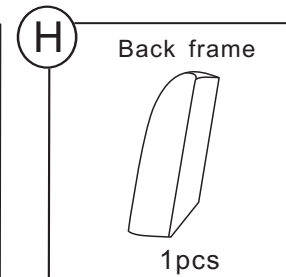
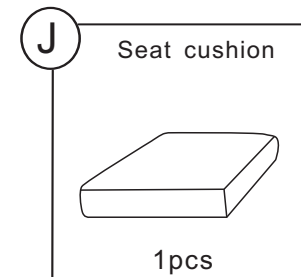
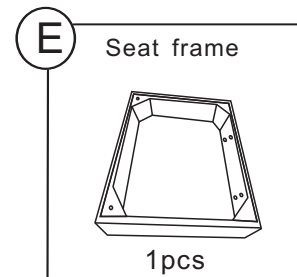



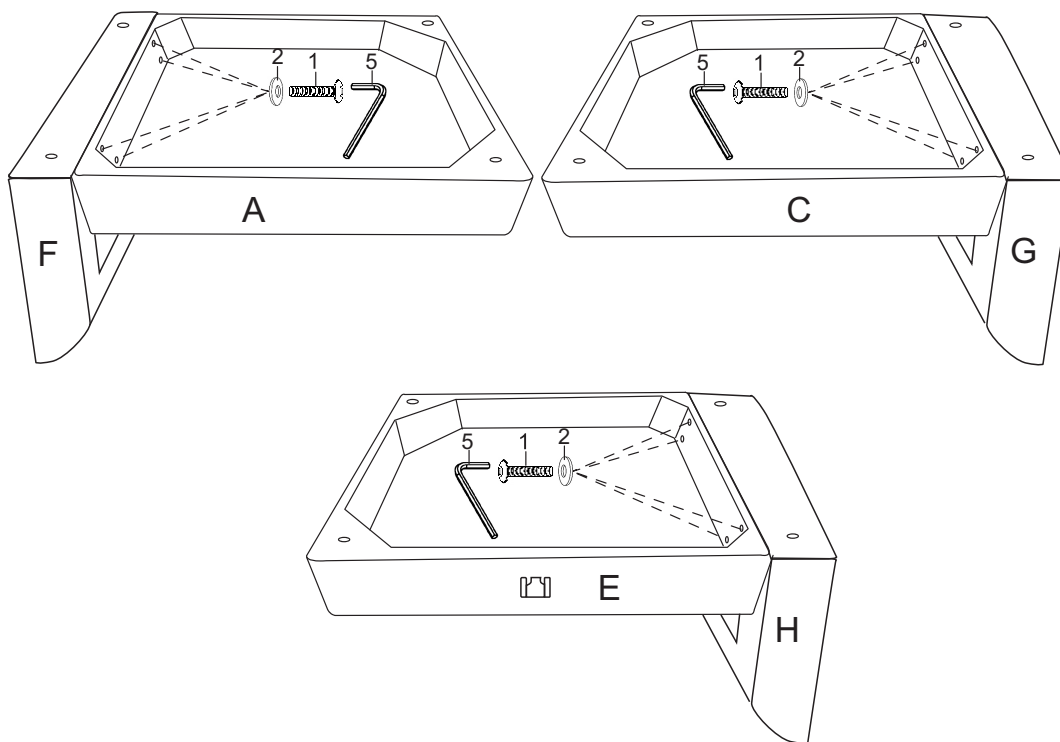





DIAGRAM 1 (Assemble the Armrest to the Seat frame)

Connect the Armrest(Part F) to the Seat frame(Part A) ,
 the Back frames(Part G)to the Seat frame(Part C),the Back frame(Part H)
 to the Seat frame(Part E)with the Screws M8X35mm(Hardware 1)and the
 Washers (Hardware 2) by Wrench (Hardware 5).

1		12pcs
2		12pcs
5		1pcs

**DIAGRAM2** (Install side seat backrest)

Fix the backrest(Part H) and the seat frame(Part E) together with
 Angle iron(Hardware4) and the Screws M6X14mm(Hardware 3)
 by Wrench (Hardware 5) .

3		4pcs
4		2pcs
5		1pcs

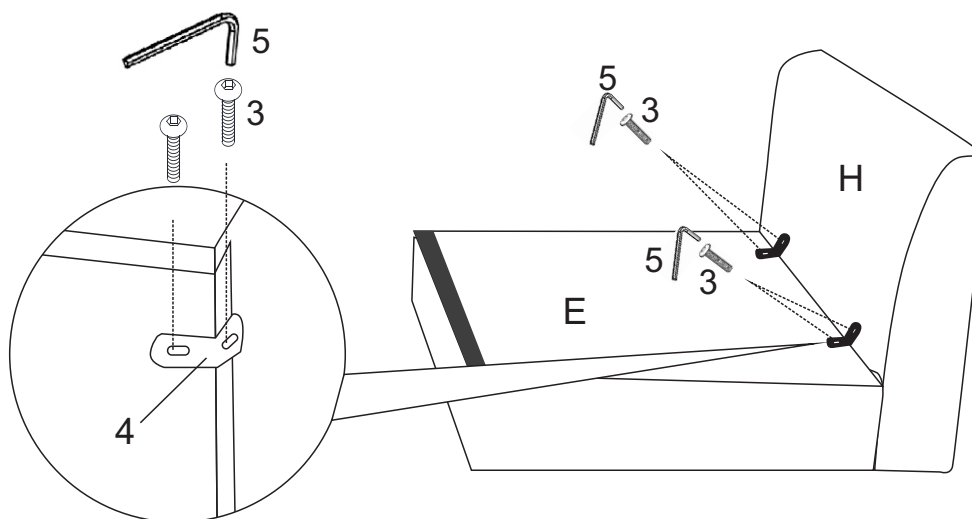

DIAGRAM 3 (Assemble the Legs)
Assemble the Seat frame (Part A&C&E) Legs.

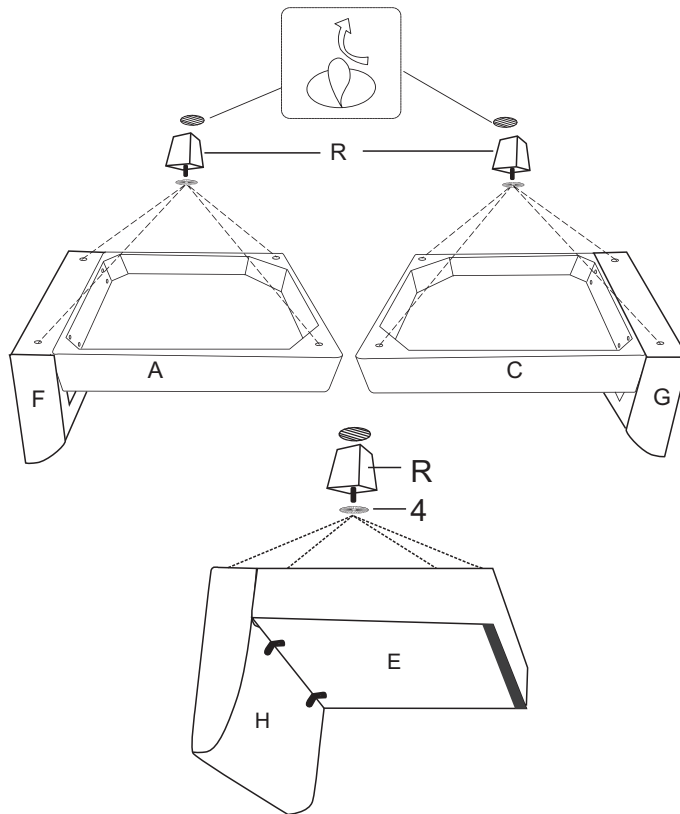

DIAGRAM 4 (Assemble the Legs)
Assemble the seat frame (Part B) and Ottoman frame (Part D) Legs.

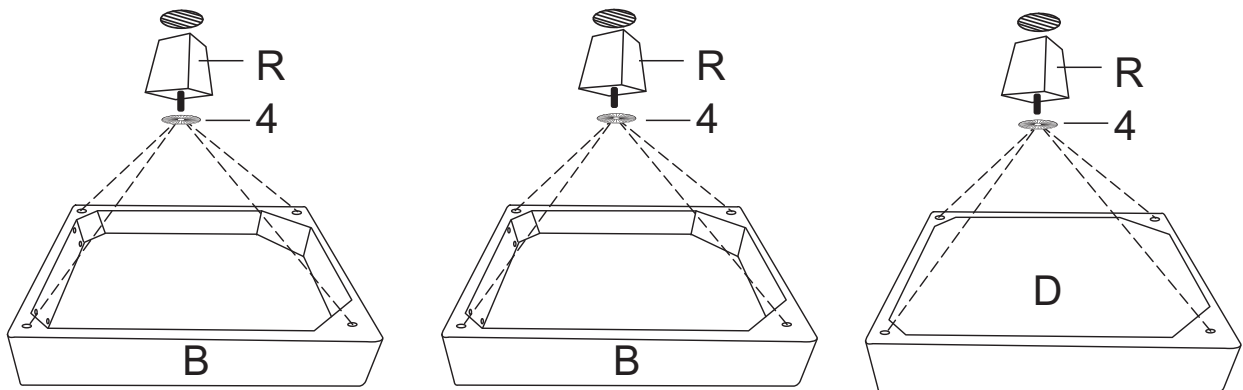



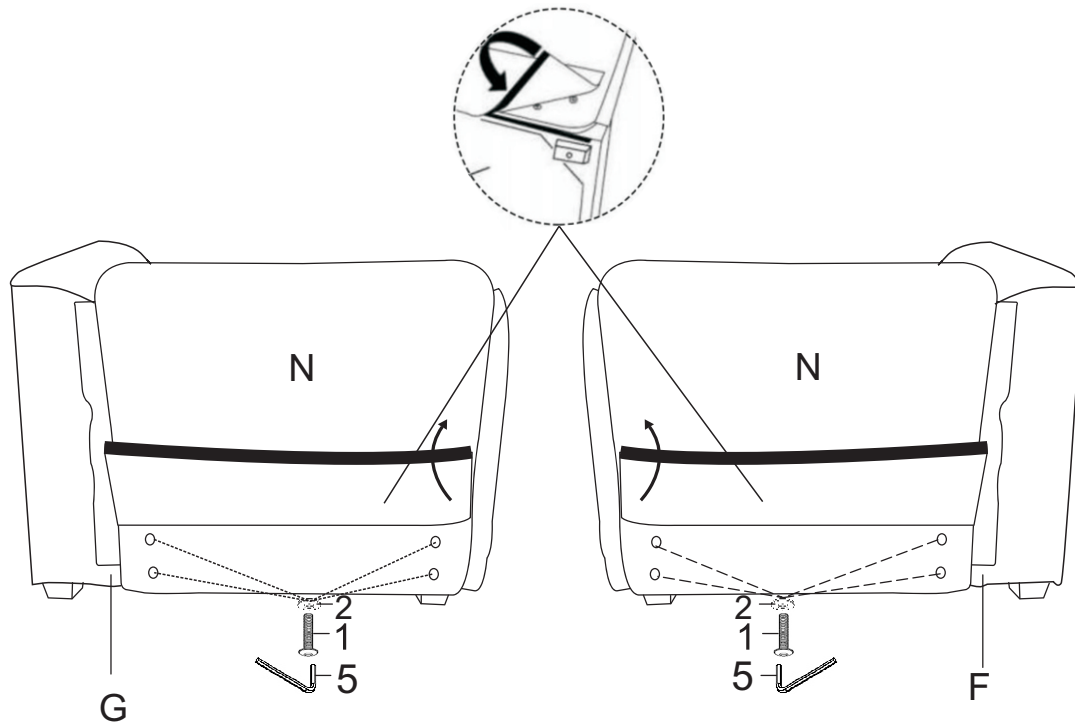

DIAGRAM 5 (Assemble the Back frames)

Connect the Back frames (Part N) to the Seat frames (Part A&C) with Screws M8x35mm (Hardware 1) and Washers (Hardware 2) by Wrench (Hardware 5) as shown. Then put Velcro pieces together. Please install the top Screws first, then the bottom Screws. Make sure all the Screws are in the holes before tightening them.

1		8pcs
2		8pcs
5		1pcs

**DIAGRAM 6** (Assemble the Back frames)

Connect the Back frames (Part N) to the Seat frames (Part B) with Screws M8x35mm (Hardware 1) and Washers (Hardware 2) by Wrench (Hardware 5) as shown. Then put Velcro pieces together. Please install the top Screws first, then the bottom Screws. Make sure all the Screws are in the holes before tightening them.

1		8pcs
2		8pcs
5		1pcs

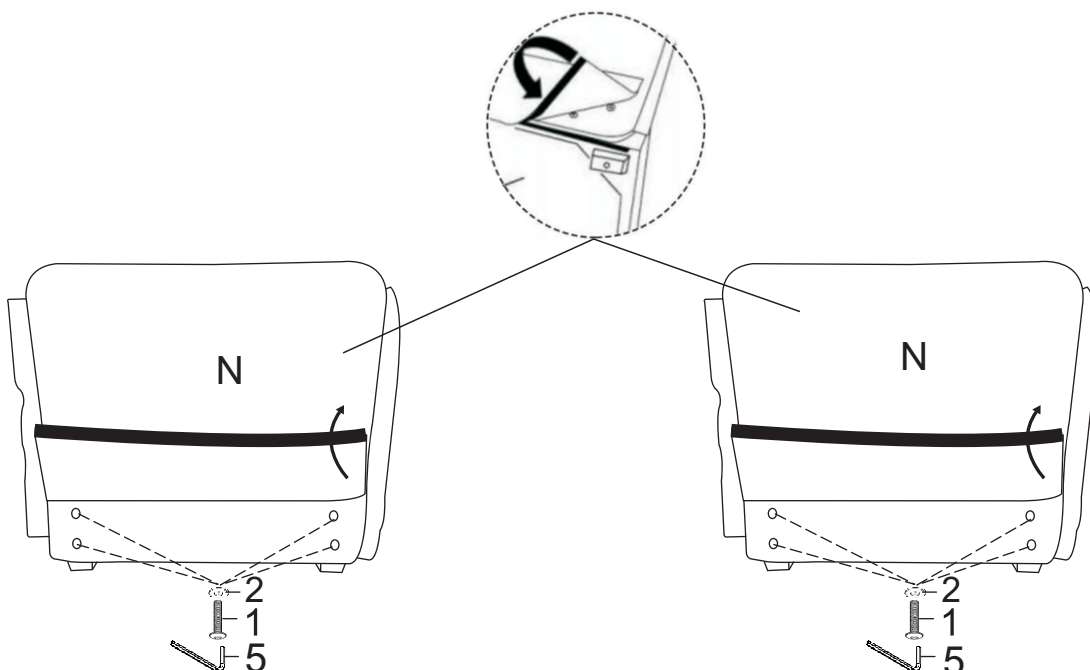

DIAGRAM 7 (Connecting the Seat frames)

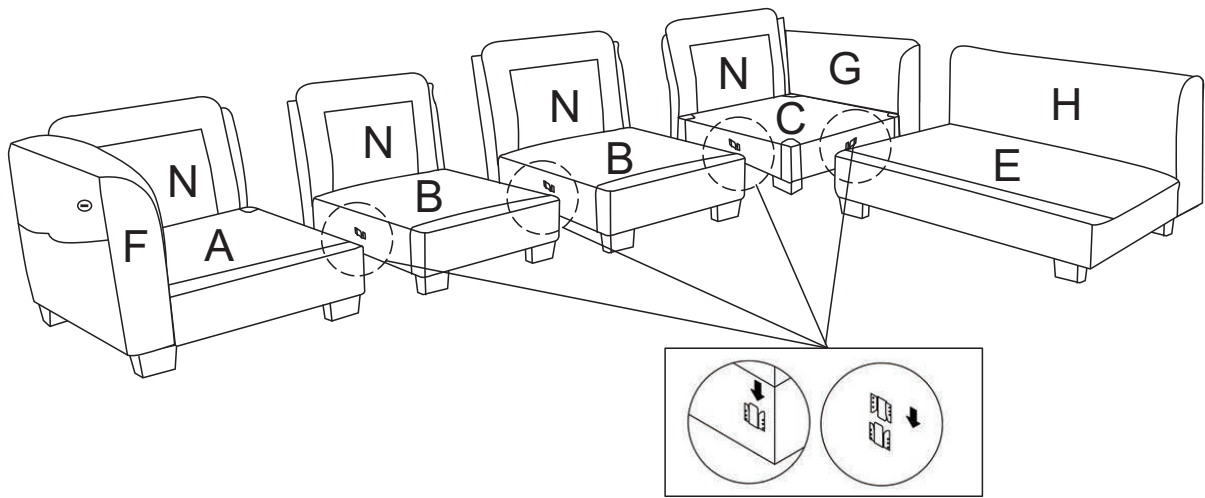
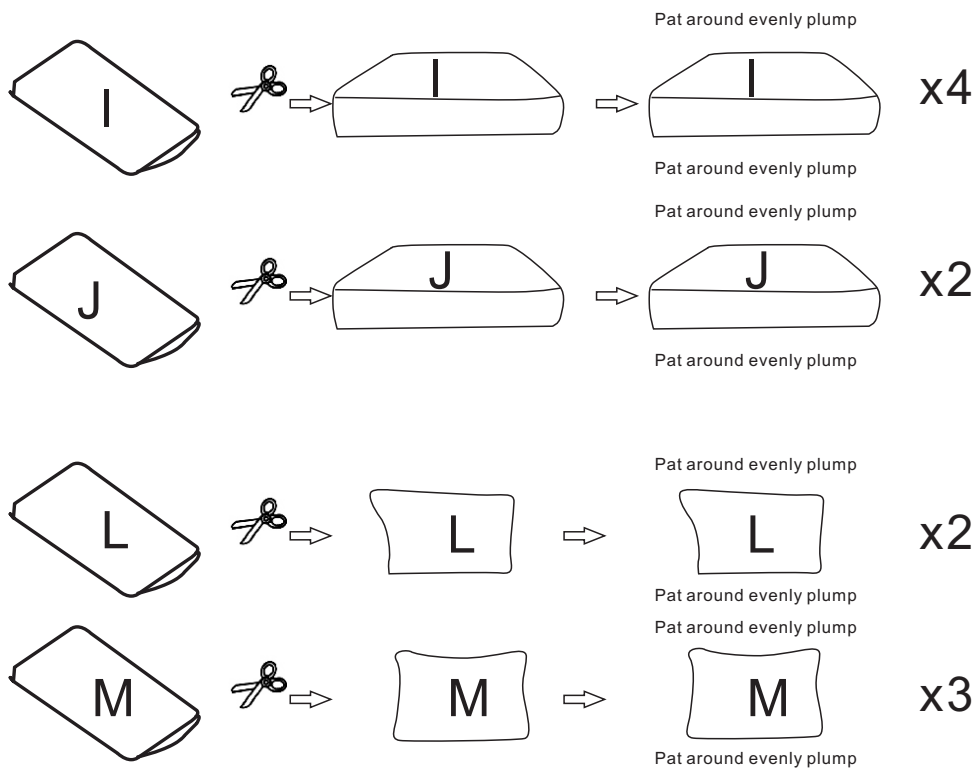

DIAGRAM 8 (Removal of compressed bags)



TIPS:

1. Please do not open the compressed packages until your sofa frame is completely assembled.
2. Compressed cushions need to be fully fulfilled within 72 hours for your perfect use.
3. Please keep children away from plastic bags or any small pieces of stuff .



DIAGRAM 9 (Place cushions on the sofa)

Put the Seat frames(Part I&J), the Back cushions (Part L&M) on the sofa.

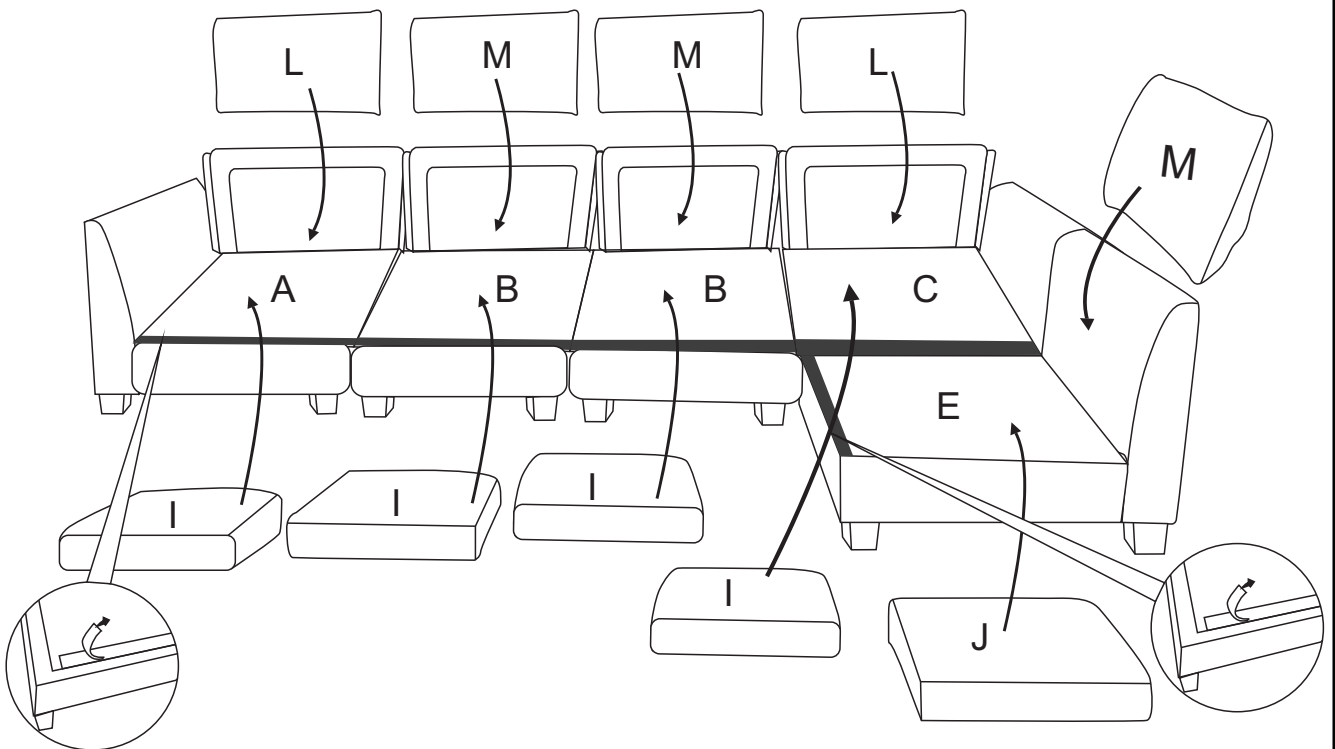
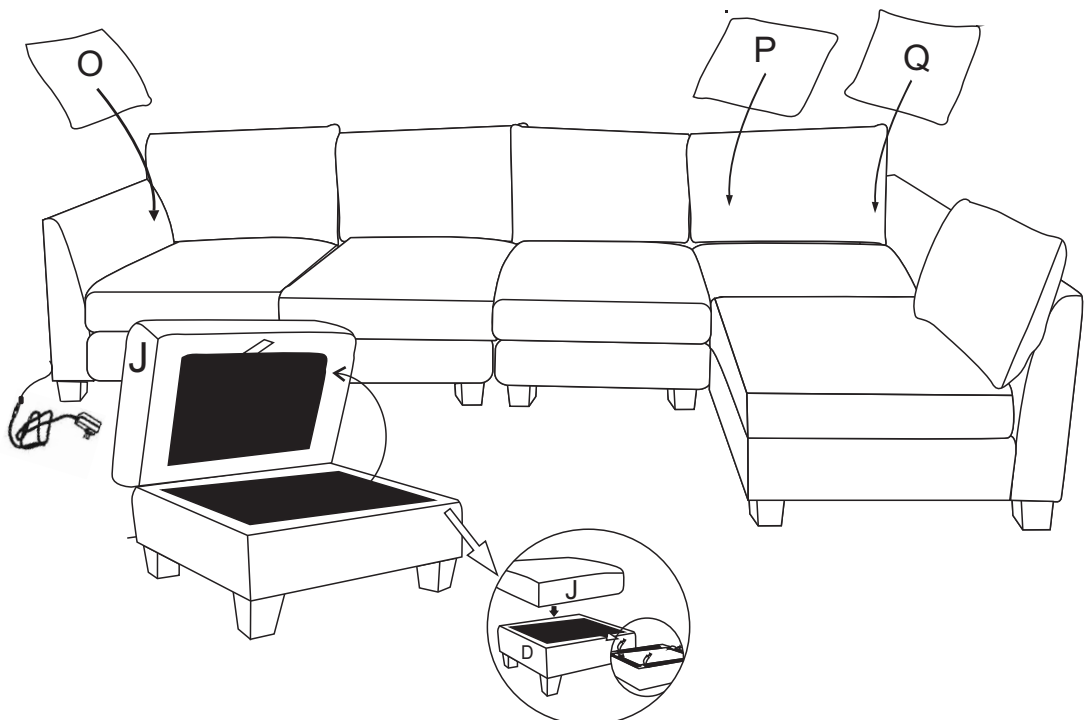
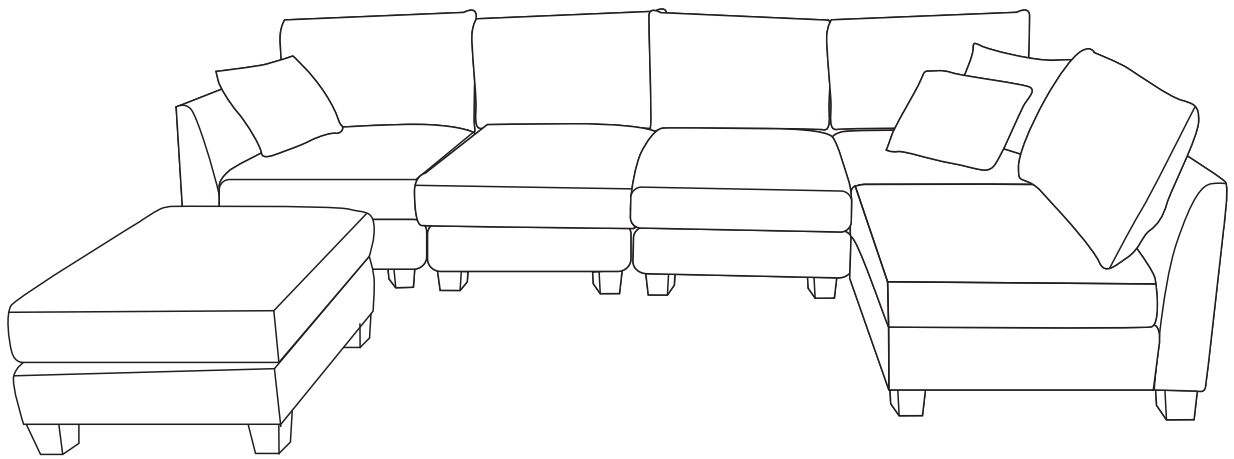

DIAGRAM 10 (Place cushion and pillows on the sofa)

Put the Ottoman cushion(Part J) and Throw pillows(Part O&P&Q) on the sofa. Recheck all the bolts before you sit on the sofa.





COMPLETE