

CARE AND MAINTENANCE

Store outdoor furniture indoors or cover well when not in use.
Remove wicker furniture from standing water. Dust regularly with small brush or vacuum
Spills should be taken care of immediately before they harden or stain with a slightly dampened sponge.

NOTICE

- * Please make sure that you have all parts indicated before you begin assembly of this item
- * This item should be assembled on a soft surface to prevent scratching the finish during assembly
- * This item may require periodic tightening







Weight Capacity : 275 Lbs (single seat)
550 Lbs (towperson seat)

Warning : Do not stand on chair/stool

Warning : Do not over torque bolts/screws



Part List and Hardware List

PIECE	DESCRIPTION	PICTURE	QUANTITY
A	Chair		2X
B	Bench		1X
C	Table		1X
D	Chair Seat Cushion		2X
E	Bench Seat Cushion		1X
F	Glass table		1X

Product Dimensions: 26.38" W x 24.02" D x 29.13 H (Chair)
44.09" W x 24.02" D x 29.13" H (Bench)
35.43" W x 19.69" D x 13.78" H (Table)

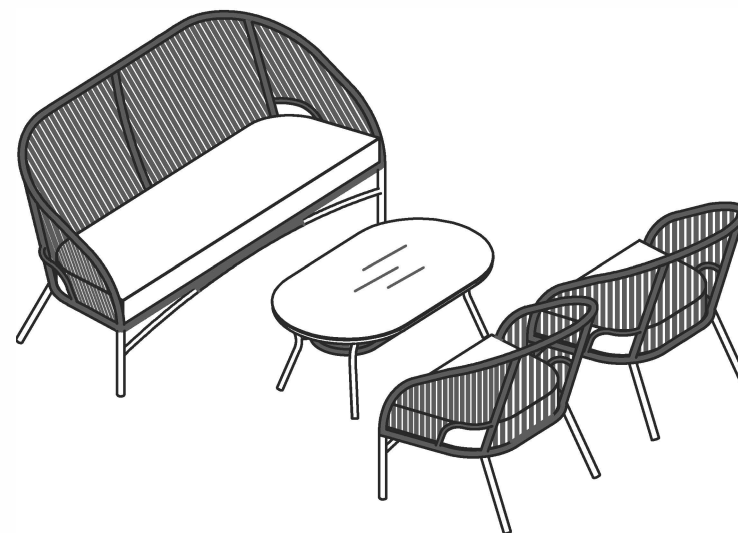

CARE AND MAINTENANCE

Store outdoor furniture indoors or cover well when not in use.
Remove wicker furniture from standing water. Dust regularly with small brush or vacuum
Spills should be taken care of immediately before they harden or stain with a slightly dampened sponge.

NOTICE

- * Please make sure that you have all parts indicated before you begin assembly of this item
- * This item should be assembled on a soft surface to prevent scratching the finish during assembly
- * This item may require periodic tightening



Weight Capacity : 275 Lbs (single seat)
550 Lbs (towperson seat)

Warning : Do not stand on chair/stool

Warning : Do not over torque bolts/screws



Part List and Hardware List

PIECE	DESCRIPTION	PICTURE	QUANTITY
C	Table		1X
F	Glass table		1X

Product Dimensions: 35.43" W x 19.69" D x 13.78" H (Table)

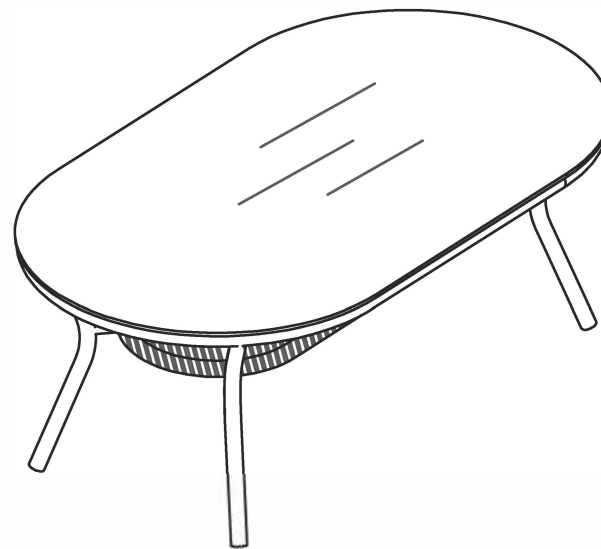

PREPARATION

Before beginning assembly of product, make sure all parts are present. Compare parts with package contents list and hardware contents list. If any part is missing or damaged, do not attempt to assemble the product.

1

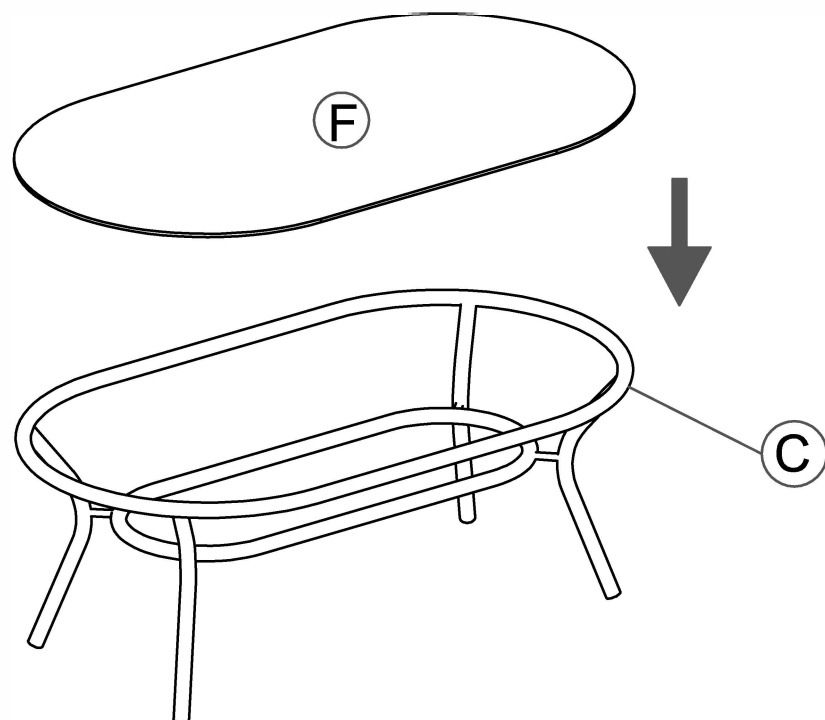

2

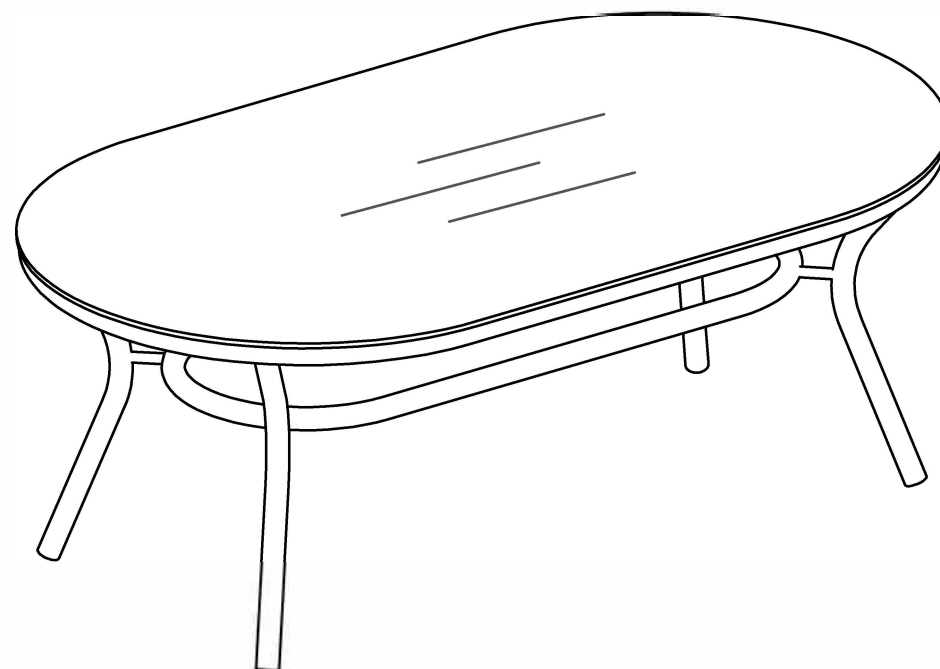

Put on Glass Table (F) to complete table