

USER MANUAL

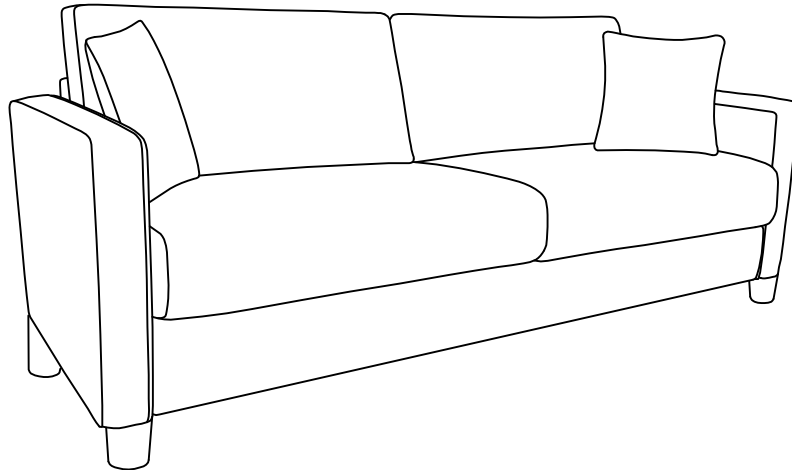

Warming Tips:

1. Review the installation instructions and check that all installation parts are complete.
2. Identify the parts (armrests) that need to be differentiated between left and right.
3. Tap the backrest and place it in the sunlight to fluff it up quickly, it takes about a few minutes for the backrest to fluff up.
4. Do not stand or jump on the parts of the sofa to avoid damage.
5. To ensure that the sofa does not get dirty, please make sure that the floor is clean enough before the installation begins.

Before you start...

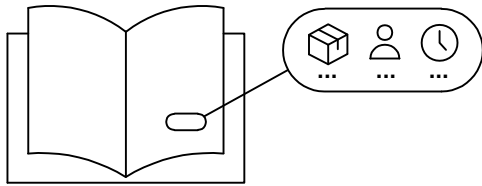

Ensure you have received all cartons and familiarize yourself with the workload. Make sure if you need someone to assist you, and that you have allocated the time required to assemble your new product.

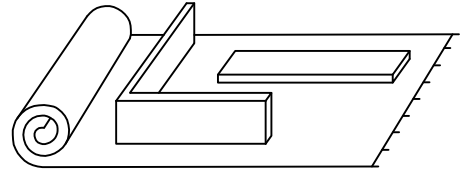

Please ensure that you leave enough space in your home for assembly. We recommend that you place cushions or cardboard on the floor to protect the floor and to ensure that the sofa does not get stained.

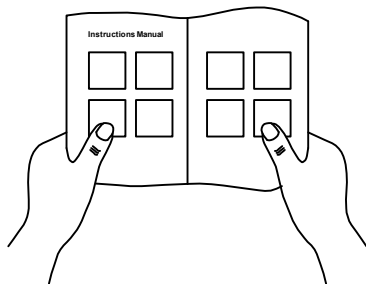

Read instructions carefully and check no parts are missing.

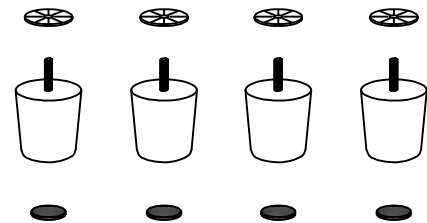

Lay out all hardware on a soft surface so you can easily identify them.

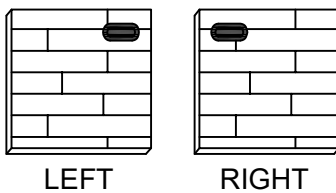

Carefully identify all components in order to differentiate which pieces are left and right.

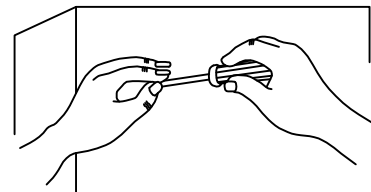

Install your new product carefully following the instructions. Don't skip ahead!

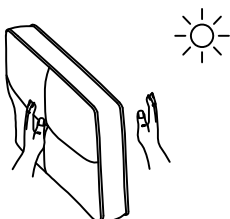

Tap the backrest and place it in the sunlight to fluff it up quickly, it takes about a few minutes for the backrest to fluff up. Pay attention: Because of the compressed packaging, there may be some creases on the cover. Please do not worry, pat it several times and wait for moments, the crease will be more natural and will not affect the use.



Do not stand or jump on the parts of the sofa to avoid damage.

Product Diagram

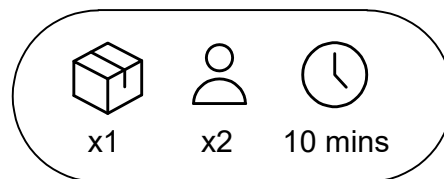

Parts

- A. Pedestal
- B. Backrest
- C. Armrest (left)
- D. Armrest (right)
- E. Cushion (seat)
- F. Cushion (back)
- G. Pillows
- H. Sofa legs
- I. Non-slip mats
- J. Reinforcement pads

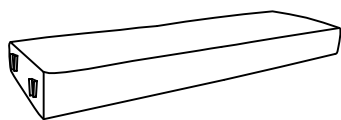
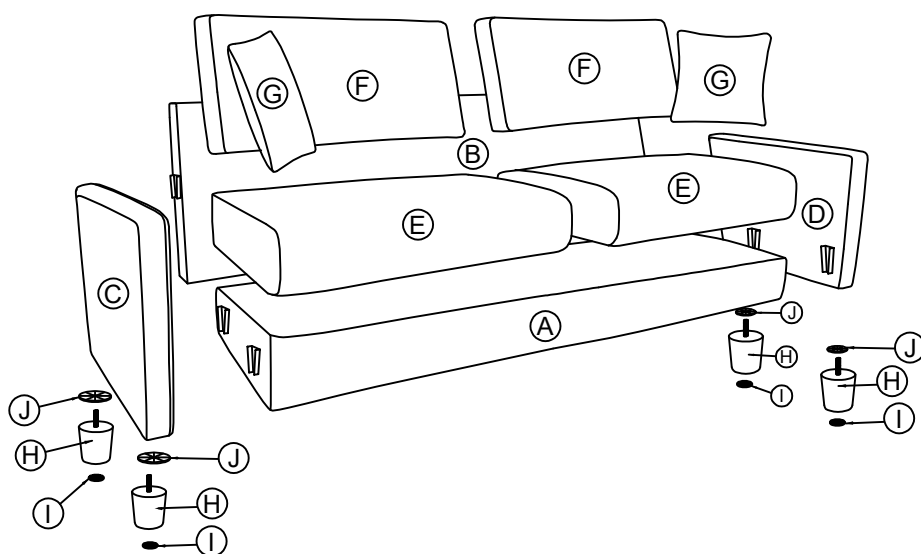

A*1



B*1

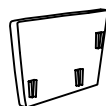

C*1

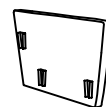

D*1



E*2



F*2



G*2



H*4



I*4



J*4

STEP 1:

Please open the zipper first and then take out the sofa legs.

Note:

The sofa legs are inside the armrests on both left and right.

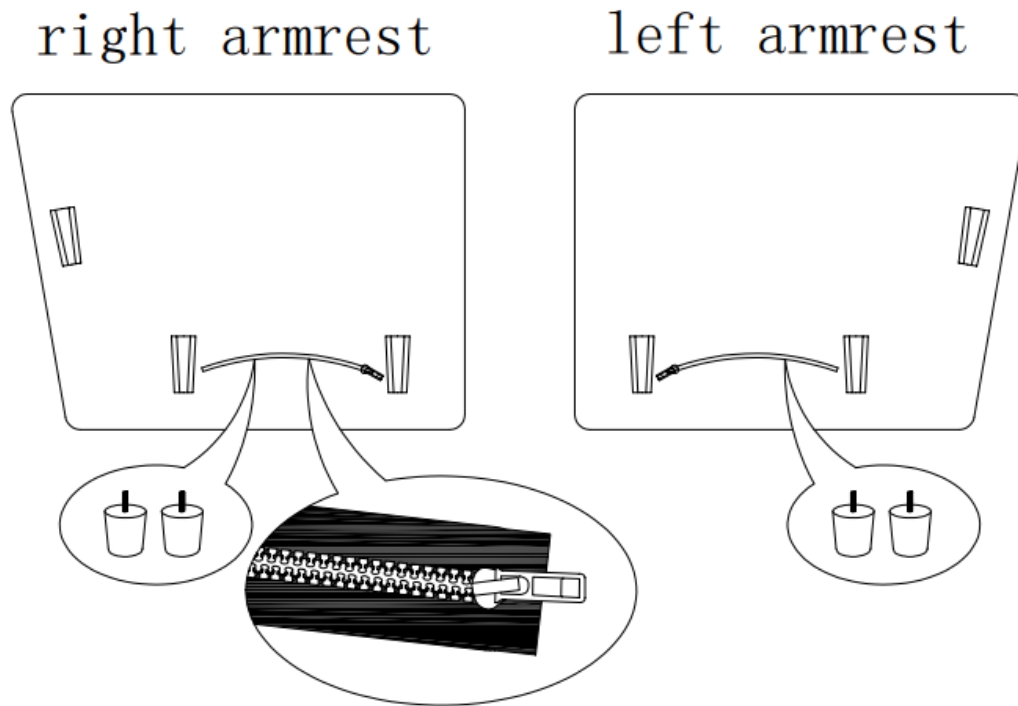

STEP 2:

Install the left and right armrests on both sides of the sofa pedestal.

Note:

- a. Please align the orbit ① first then align the orbit ② .
- b. Then slide from top to decline and use your leg to push the armrest inward at the same time.
- c. Please kindly check all orbits must be well connected before the next step.

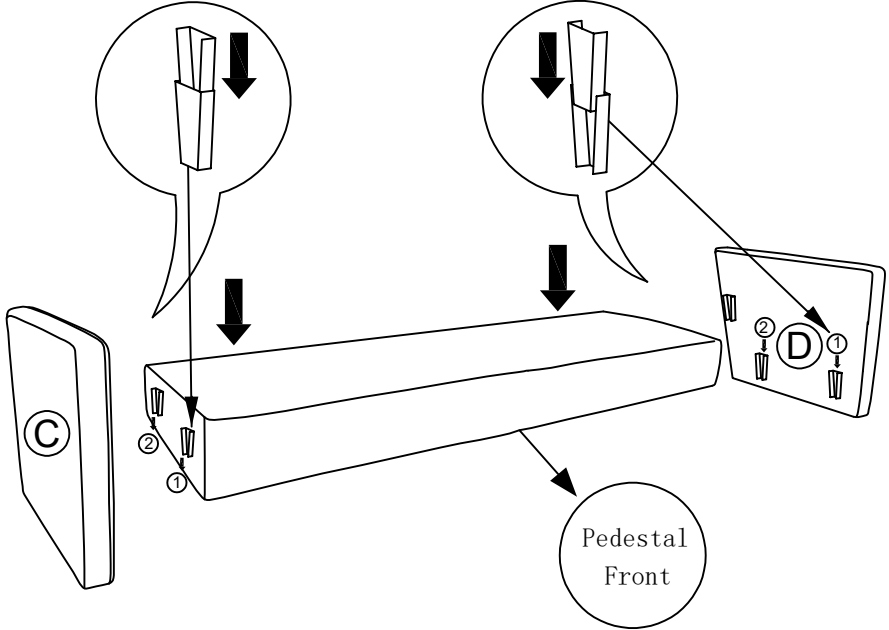

STEP 3:

- a. Set the fixed pads into the sofa legs (H), then install the sofa legs to the pedestal.
- b. Place the non-slip pad to the bottom of the sofa legs (H), and the sofa legs are installed.

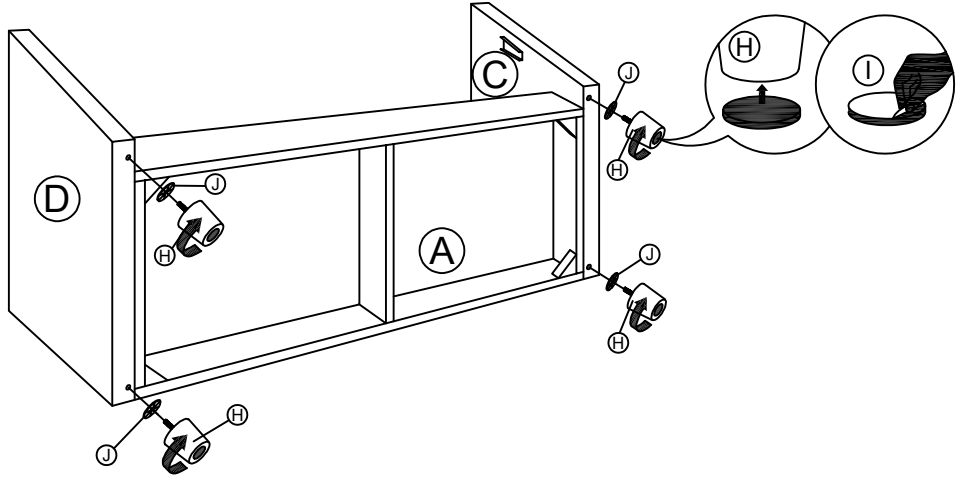

STEP 4:

Install the backrest (B) to the sofa pedestal.

Note: Place 2 orbits of the backrest on the connection of the armrest.

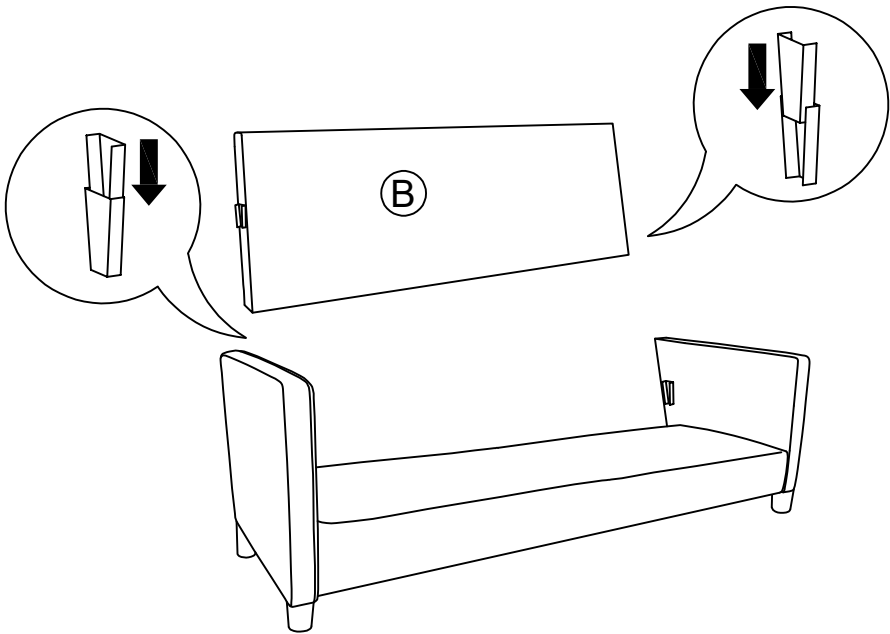

STEP 5:

Put the cushion (E) on the pedestal.

Note: Please remove the cover tape from the velcro before placing the cushion.

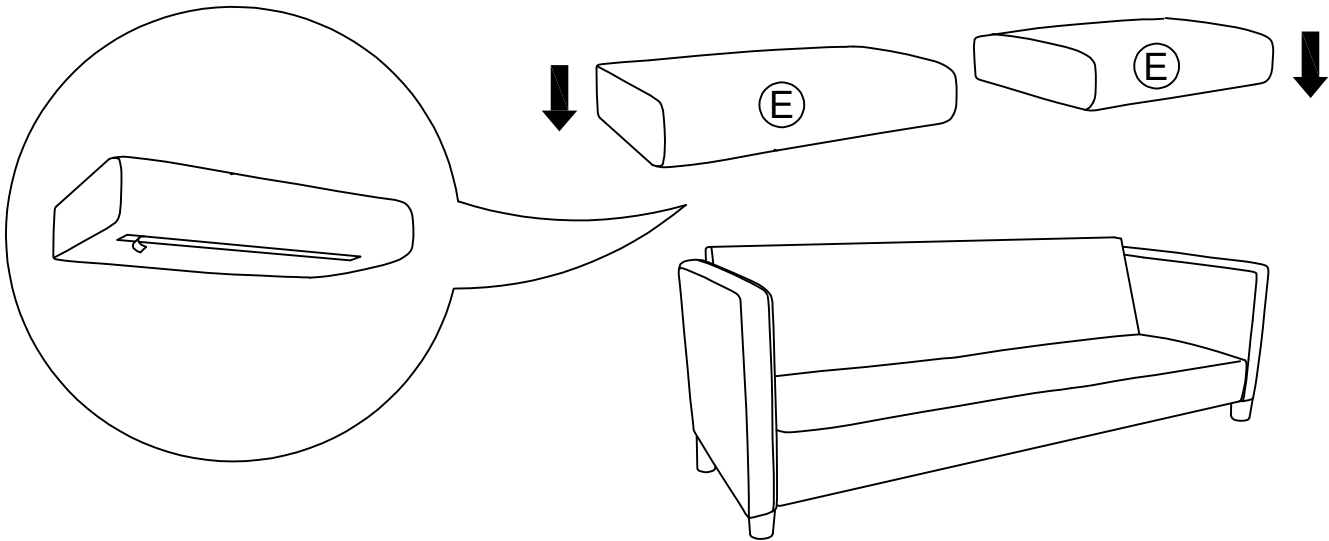

STEP 6:

Place the fluffy cushion (F) on the backrest.

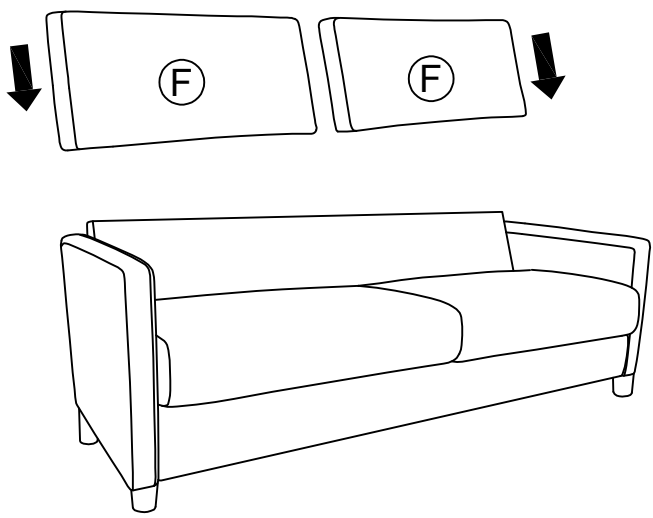

STEP 7:

Place the pillows on the sofa and decorate your sofa.

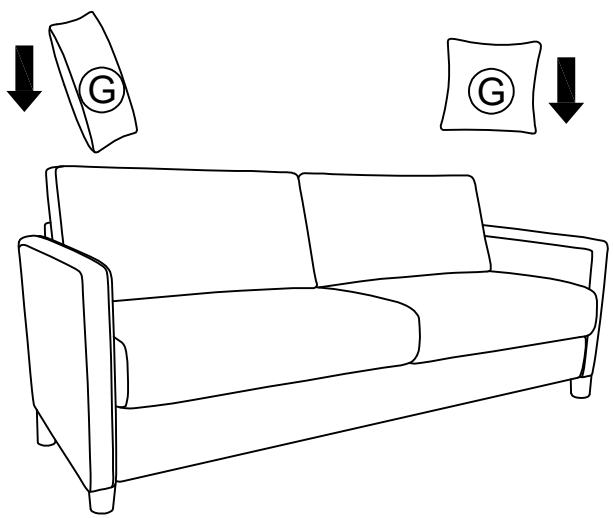

STEP 8:

Your sofa may require dressing on delivery.

Before using, please reshape the cushions to restore them to their original beauty.

Note: Because of the compressed package, it will need to take 48 hours to completely recover.

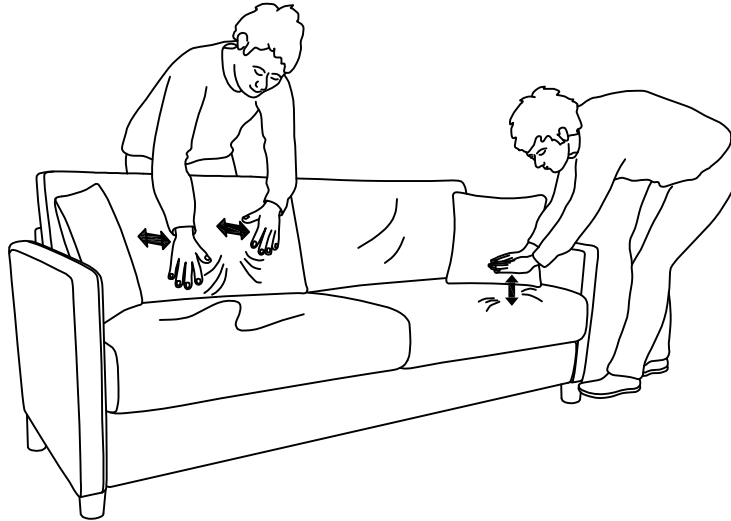

STEP 9:

The sofa has been installed, and you can start enjoying your leisure time.

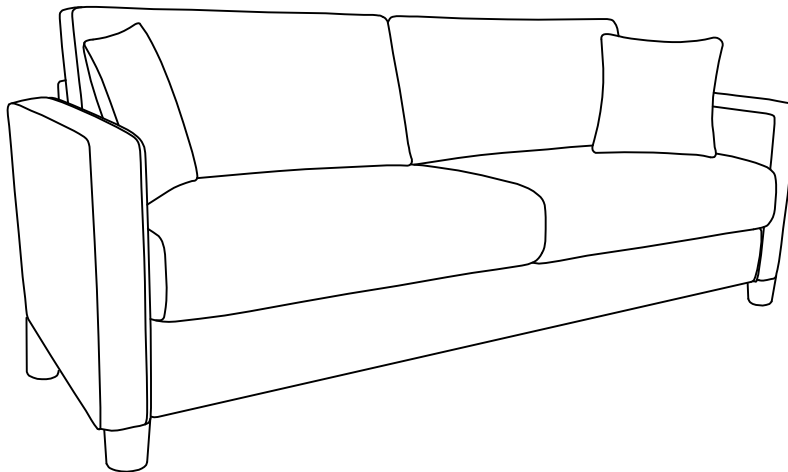

If you need any further assistance with our amazing sofa (especially when it comes to installation), please don't hesitate to contact us via email at: [**support@kidirect.net**](mailto:support@kidirect.net)

We're always here to help!

Thank you so much for choosing us, and have a fantastic day!^-^