







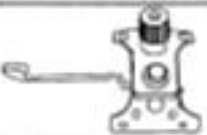

A		x5
B		x1
C		x1
D		x1
E		x1
F		x2
G		x1
H		x2
I		x2
J		x6
K		x4
L		x10
M		x1

- Ⓜ Please note bolts are located in their fixing positions
- Ⓜ Veuillez noter que les boulons sont situés dans leur position de fixation
- Ⓜ Verificare che i bulloni siano posizionati nelle relative posizioni di fissaggio
- Ⓜ Hinweis: Die Bolzen befinden sich in ihren Befestigungspositionen
- Ⓜ Por favor, observe que los pernos se sit an en sus posiciones de ajuste
- Ⓜ Note que os parafusos estão posicionados nas suas posiões de fixa o
- Ⓜ Let op: bouten zijn op de bevestigingspunten aangebracht

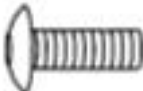
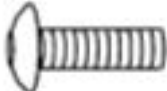
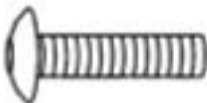
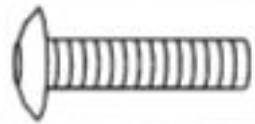

Note:

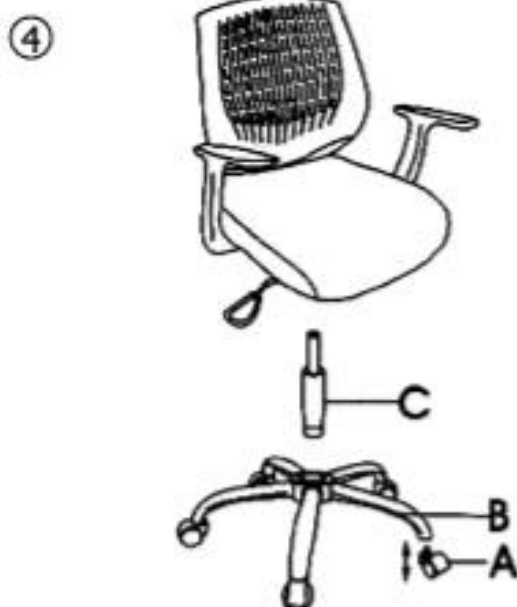
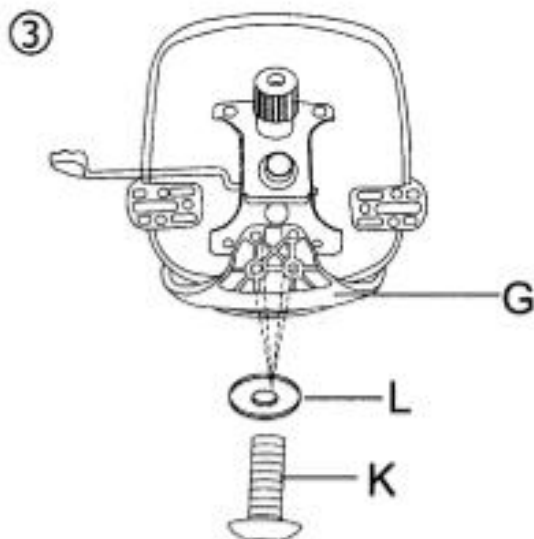
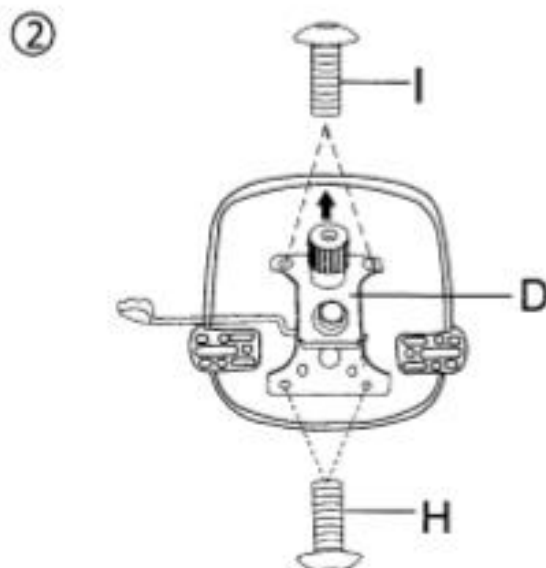
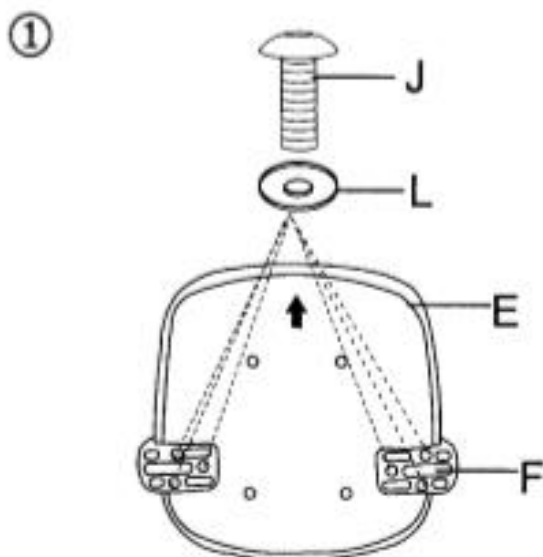
Push the backrest (F) and seat (D) until position 1 attached to position 2.

Maintain close and tighten the screws.

IMPORTANT! Do not tighten bolts fully until you have completed assembly
IMPORTANT! Ne serrez pas complètement les boulons avant d'avoir terminé le montage
IMPORTANT! Non serrate completamente le viti finché non avrete completato il montaggio.
WICHTIG! Schrauben erst nach vollständiger Montage fest anziehen.
IMPORTANT! No apriete en su totalidad los pernos hasta no haber completado el montaje.
BELANGRIJK! Draai de bouten niet helemaal vast voordat u de stoel volledig in elkaar hebt gezet.

