























Assembly Instructions

Care & Maintenance

 	<ul style="list-style-type: none">● Not for commercial use. For residential use only.
 	<ul style="list-style-type: none">● Furniture may scratch floors. We recommend using furniture pads to protect your floors.
 	<ul style="list-style-type: none">● Do not put hot items directly on furniture surface.
 	<ul style="list-style-type: none">● Do not clean furniture with harsh cleansers or polish.
 	<ul style="list-style-type: none">● Do not place furniture under direct sunlight.
 	<ul style="list-style-type: none">● Do not place furniture near heating or cooling vents.
 	<ul style="list-style-type: none">● Do not write on furniture without a padded barrier to protect the surface.
 	<ul style="list-style-type: none">● Do not place furniture outside. For indoor use only.
 	<ul style="list-style-type: none">● Stains may be removed with mild soap solution and damp cloth.
 	<ul style="list-style-type: none">● Children should not climb or jump on the furniture.
 	<ul style="list-style-type: none">● Dust and pick-up spills using a clean, non-colored, lint-free cloth.



Please look in the box for hardware packs and legs.

Sets often ship in multiple boxes and may arrive a day or two apart.

King Bed

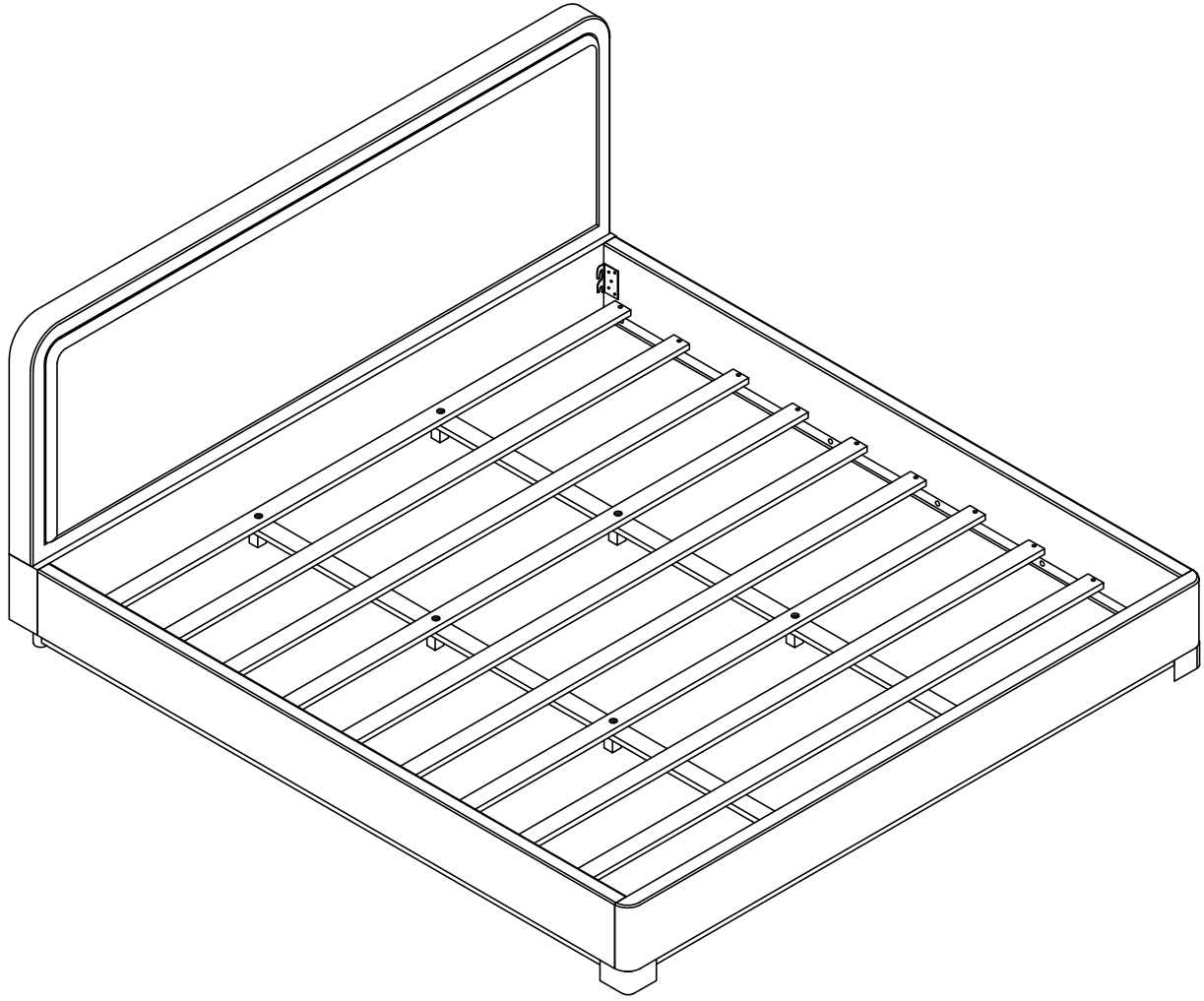
Part List

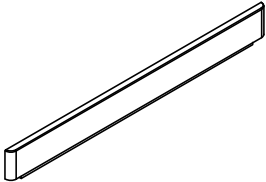
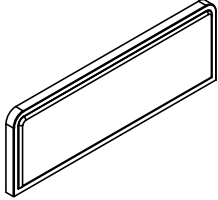
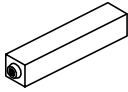

Label	Picture	Description	QTY
③		Footboard	1pc
④		Headboard	1pc
⑧		Center Support Leg	8pcs
⑪		Headboard leg	2pcs
⑫		Footboard leg	2pcs

Part List

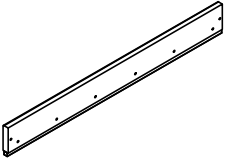
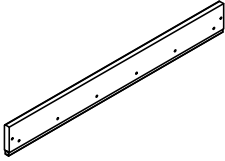
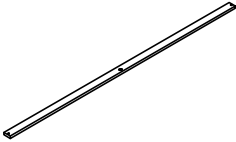
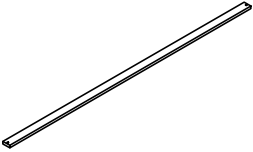
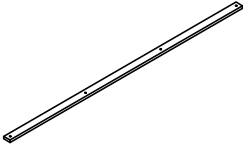
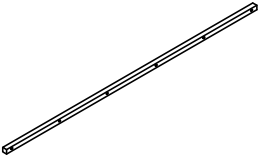
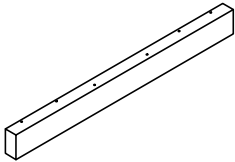

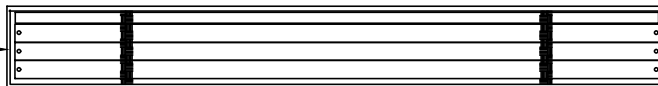

①		Side Rail(R)	1pc
②		Side Rail(L)	1pc
⑤		Slats with 4 pre-holes	4pcs
⑥		Slats with 2 pre-holes	6pcs
⑦		Middle Support bar	2pcs
⑨		Support Rail	2pcs
⑩		Headboard Storage	1pc

⑩

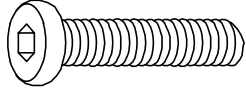
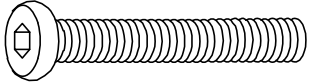
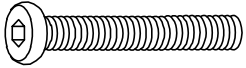

Noted : Slats with 4 pre-holes (5) Slats with 2pre-holes (6) and are packaged behind the Headboard Storage (10).



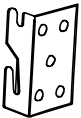
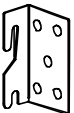
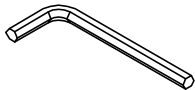



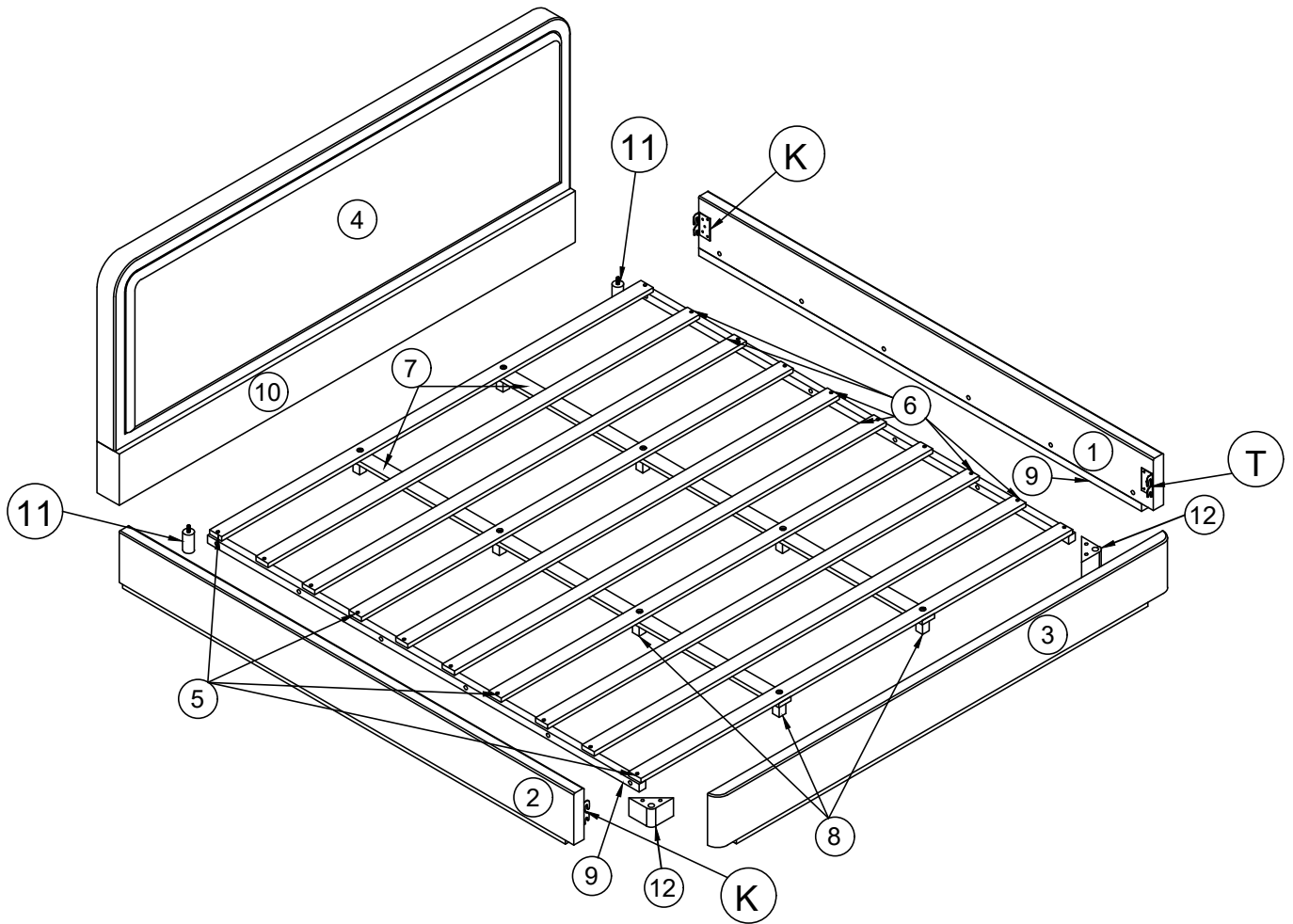

Hardware





Label	Picture	Description	QTY
A		Screw(4x30mm)	40+1pcs
B		Bolts(5/16x30mm)	12+1pcs
C		Bolts(5/16x50mm)	18+1pcs
D		Bolts(1/4x50mm)	10+1pcs
E		Lock washer(5/16x20mm)	30+1pcs
F		Flat washer(5/16x20mm)	30+1pcs
G		Lock washer(1/4x18mm)	10+1pcs
H		Flat washer(1/4x18mm)	10+1pcs
T		Metal pad(L)	2pcs
K		Metal pad(R)	2pcs
M		Allen WrenchM4)	1+1

Assembly Preparation

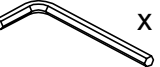
Before Beginning assembly:



A  x 40pcs+1	C  x 18pcs+1	E  x 30pcs+1	G  x 10pcs+1
B  x 12pcs+1	D  x 10pcs+1	F  x 30pcs+1	H  x 10pcs+1
			M  x 1pcs+1

-  Read the instructions cover to cover
-  Have 2 adults on hand for assembly
-  Do not assemble on flooring or carpet
-  Assemble on a clean, non-marring surface (packing foam)
-  Save all packaging until finished

Assembly Steps

OVERVIEW

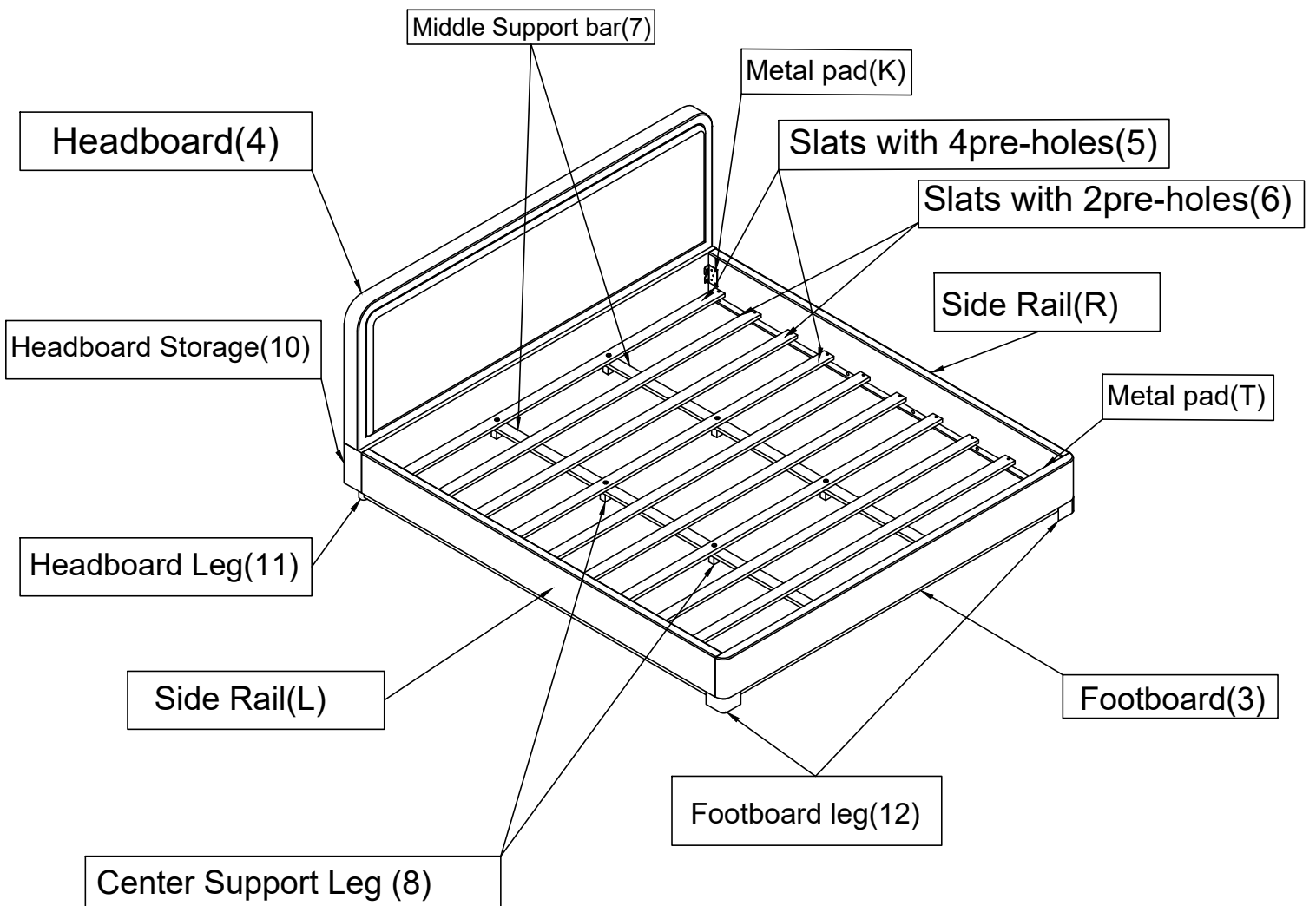

FRONT FACING

This Bed have multiple parts and may require up to 30 minutes to assemble. To give you an overview of the Bed parts, the above picture is to help you put the various parts into perspective. Please read through the instructions below to familiarise yourself with the parts and steps before assembly.

Note: It is recommended that you have an adult partner to assist during the entire assembly process.

Step 1

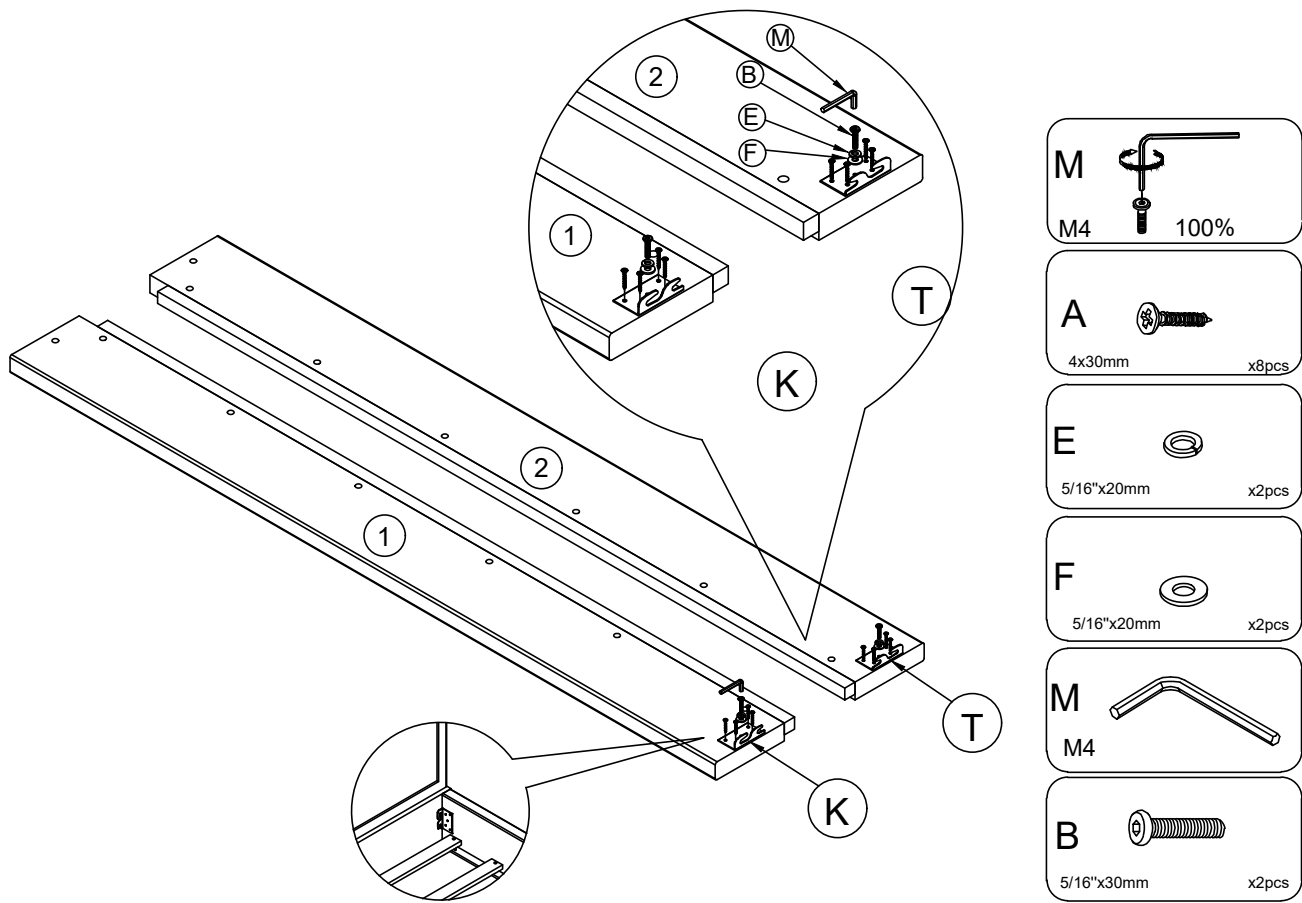

Attach the Metal pad (K) to the Side Rail (R) (1), attach the Metal pad (T) to the Side Rail (L) (2) .
 By using the Bolts (B) and Flat Washer (F) with the Lock Washer (E) and Screw (A) to connect the Metal pad
 and the Side Rail (Note: The Metal pad hook is facing down and this place is connected to the Headboard Storage (10))

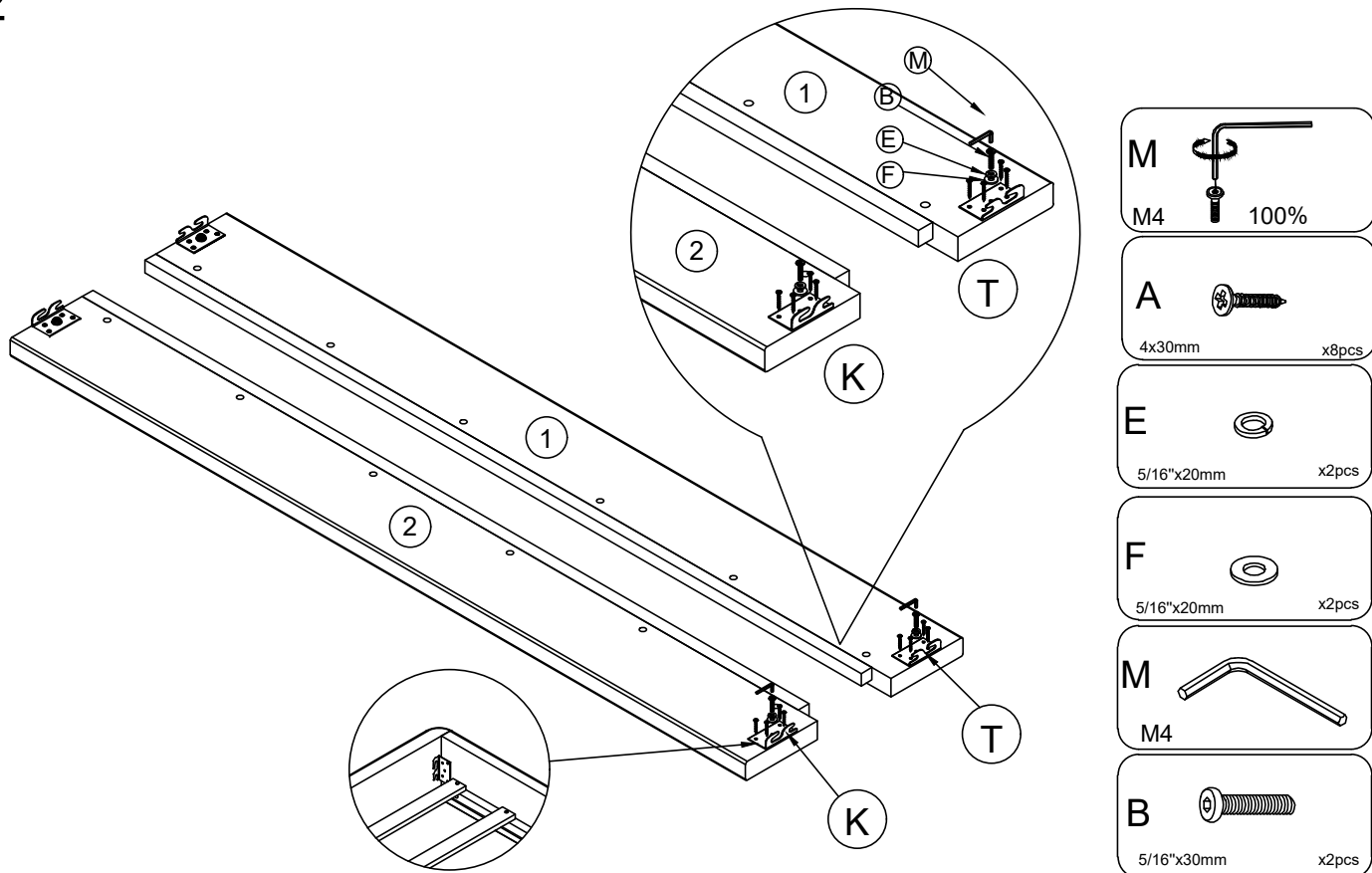

Step 2

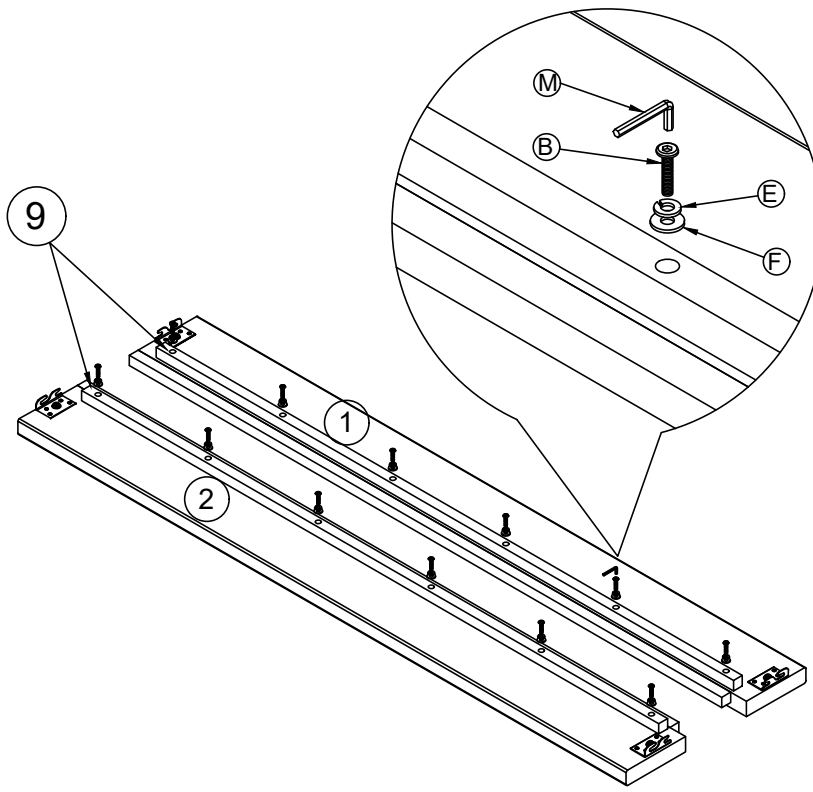

Use the Metal pad (T) to attach to the Side Rail (1), use the Metal pad (K) to attach the Side Rail (2).
 By using the Screw (A) and the Bolts (B) with M4 Allen Wrench (M) to connect the Metal pad and the Side Rail
 (Note :The direction of the Metal pad and this place is connected to the Footboard (3)).

Step 3

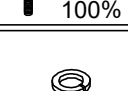

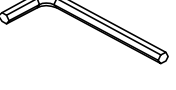
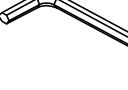

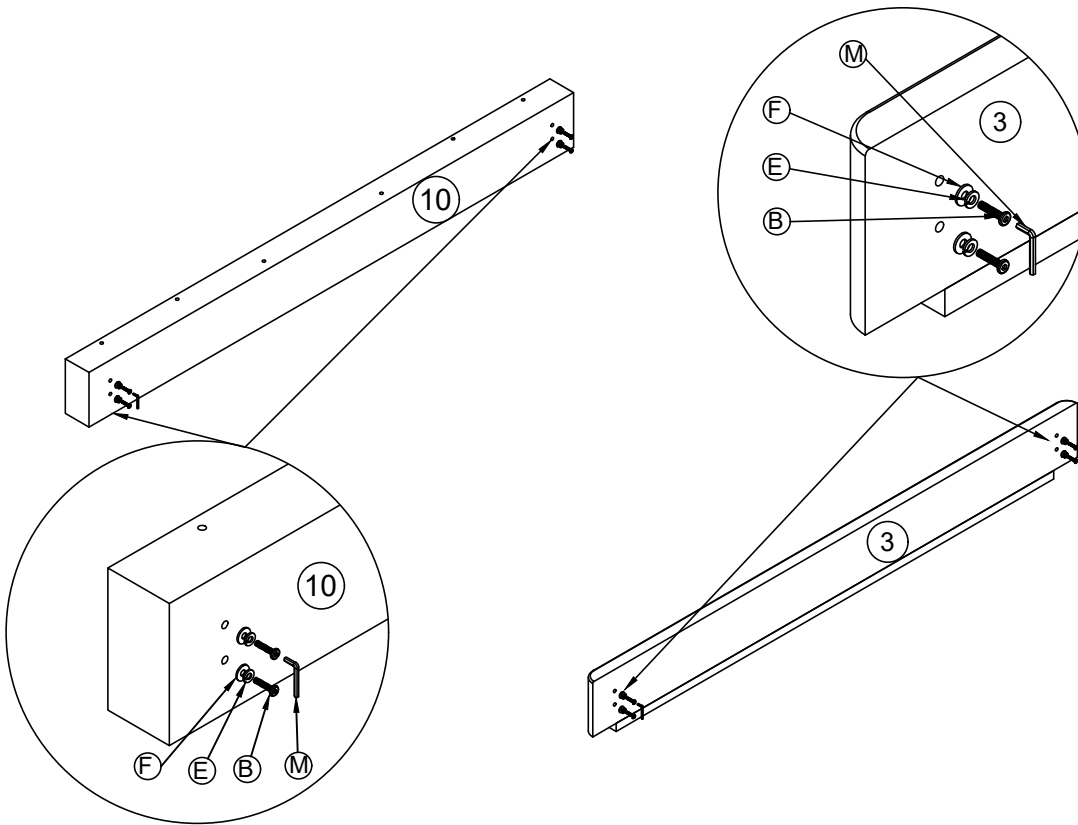

- M**  100%
- E**  5/16"x20mm x12pcs
- F**  5/16"x20mm x12pcs
- M**  M4
- C**  5/16"x50mm x12pcs

Attach the Support Rail (9) to the Side Rail (1) and the Side Rail (2). By using the Bolts (C), the Flat Washer (F) and the Lock Washer (E) with M4 Allen Wrench (M)

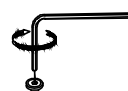
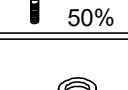
Step 4



- M**  M4 50%
- E**  5/16"x20mm x8pcs
- F**  5/16"x20mm x8pcs
- M**  M4
- B**  5/16"x30mm x8pcs

Use Bolts (B) and Lock Washer (E) with Flat Washer (F). Then attach 1/2 Bolts (B) to the Headboard Storage (10) and Footboard (3)

Step 5

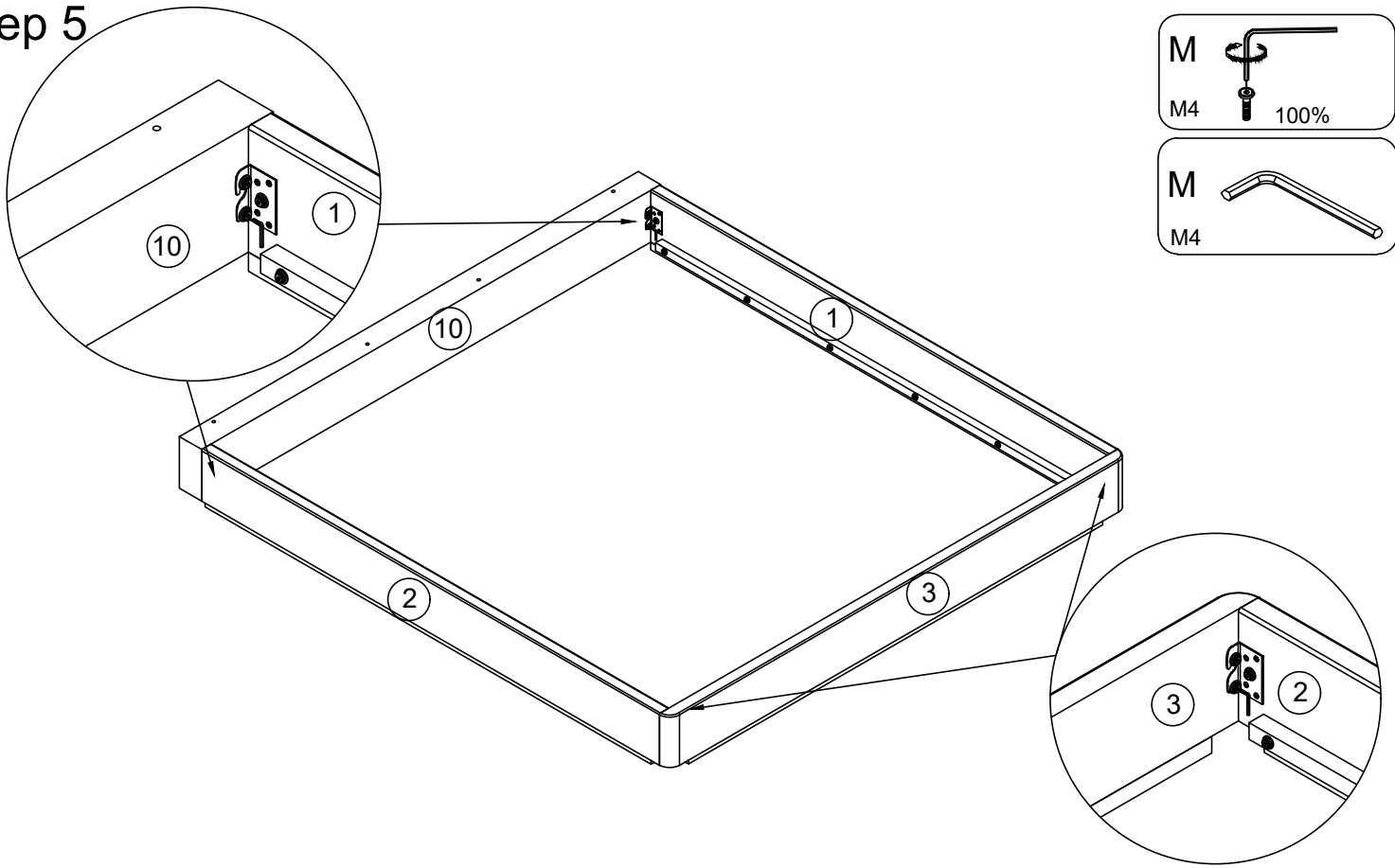

Attach the Side Rail (1) and the Side Rail (2) to the Headboard Storage (10) (Note: the direction of the Metal pad is down), by using M4 Allen Wrench (M) to tighten the Bolts (B). Then attach the Footboard (3) to the Side Rail (1) and the Side Rail (2) (Note: the direction of the Metal pad is down), by using M4 Allen Wrench (M) to tighten the Bolts (B).

Step 6

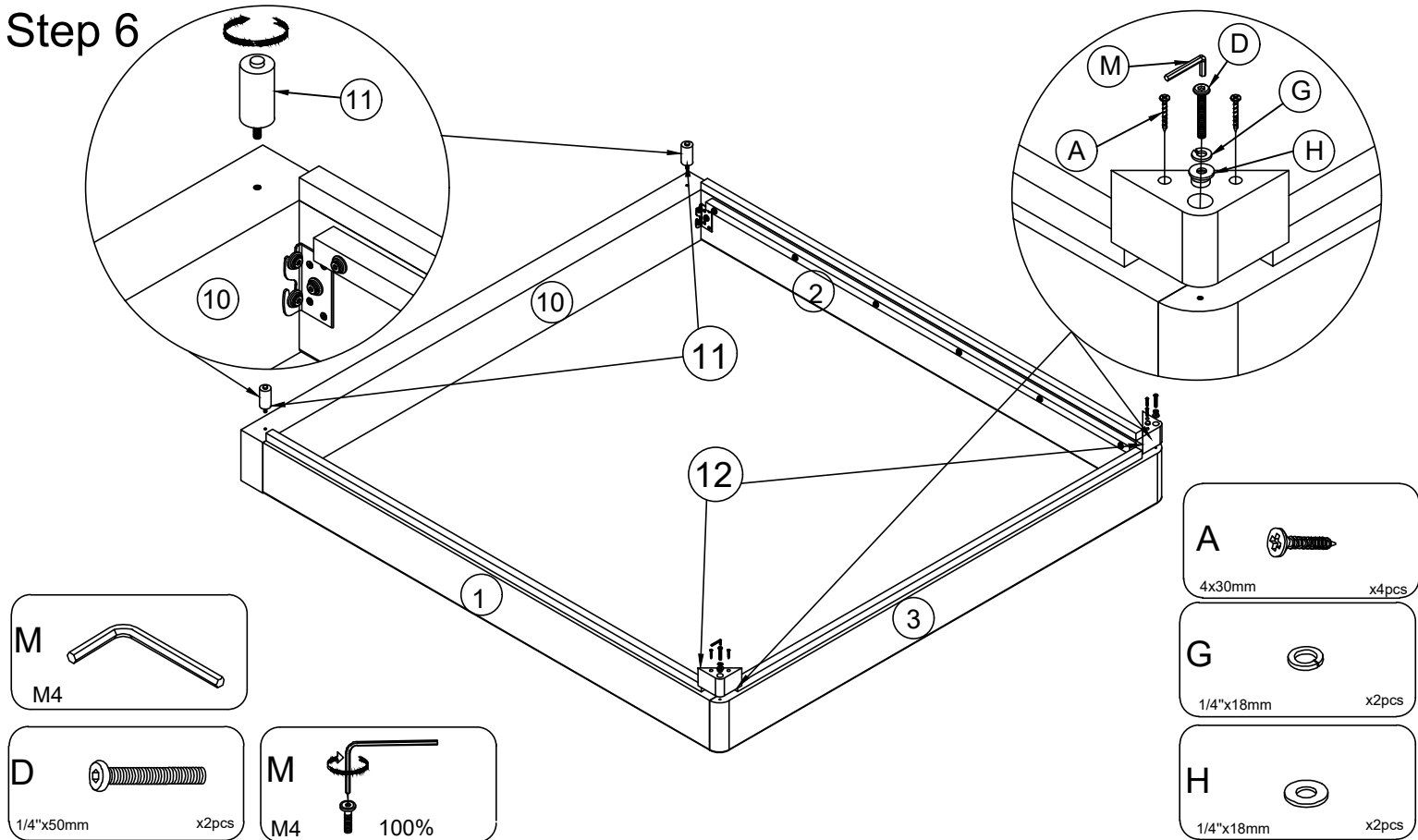

Turn the bottom of the frame up, put the Headboard Leg (11) into the Headboard Storage (10). Use Bolts (B), Lock washer (G), Flat washer (H) with M4 Allen Wrench (M) to attach the Footboard Leg (12) to the Footboard (3), then shoot 4 screw (A).

Step 7

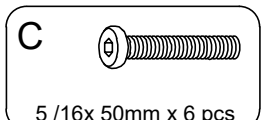
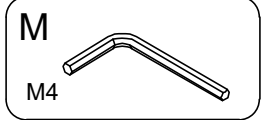
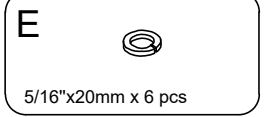
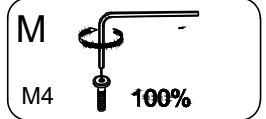
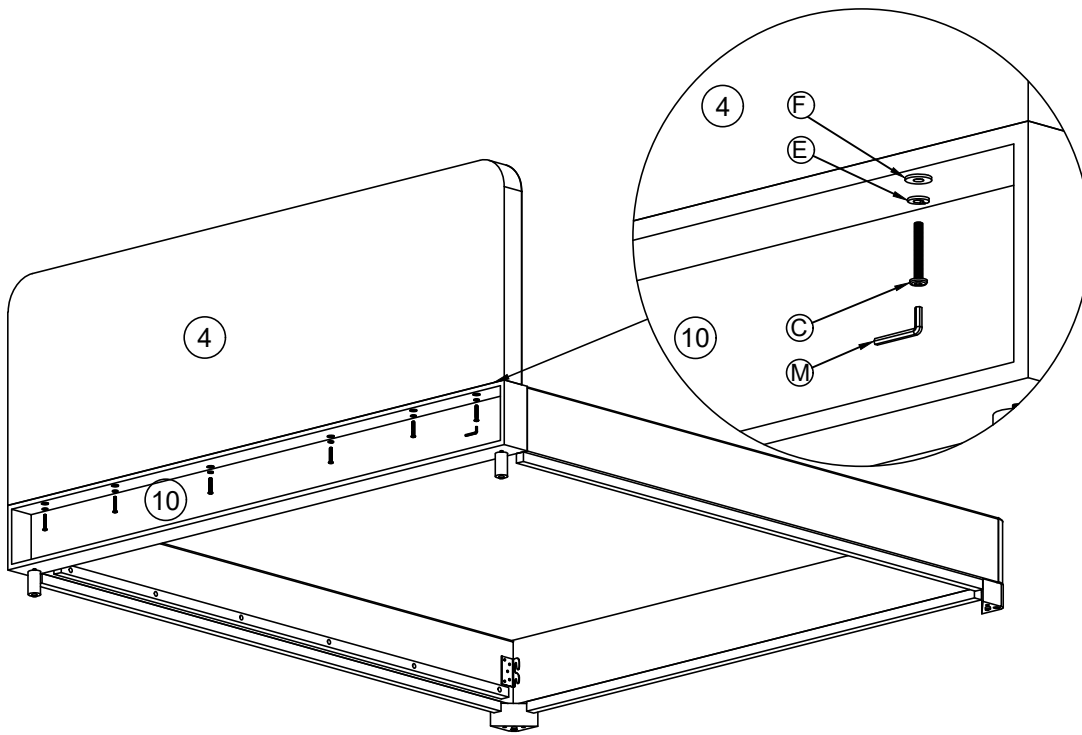

Use the bolts (C), Lock washer (E) and Flat washer (F) to connect the Headboard (4) and the Headboard Storage (10) then tighten with Allen Wrench (M)

Step 8

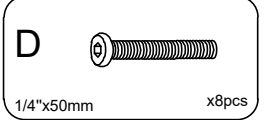
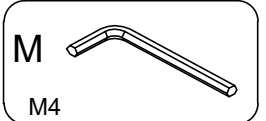
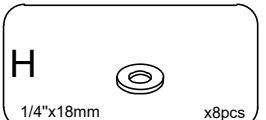
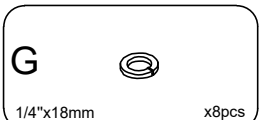
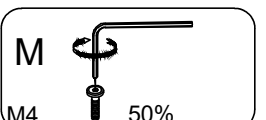
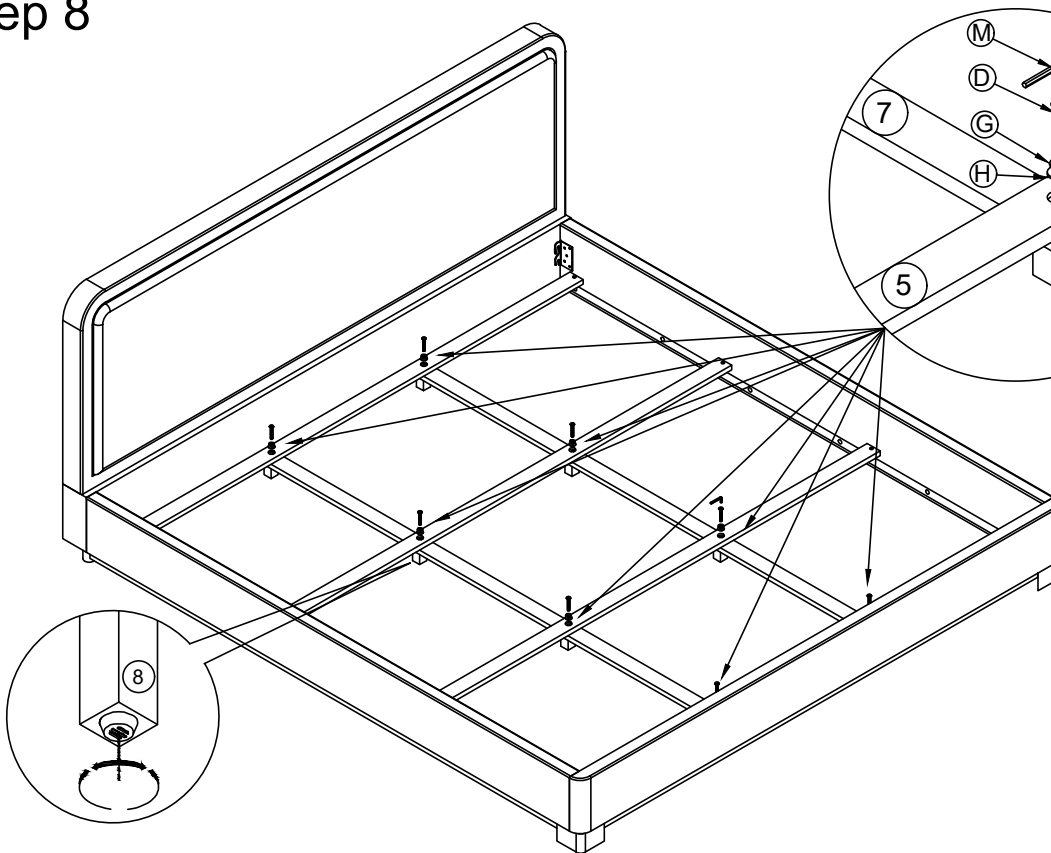

Align the assembly position on the Middle Support Bar (7) with the Center Support Leg (8) and the Slats with 4 pre-holes (5). Then attach the Slats with 4 pre-holes (5) and the Middle Support Bar (7) to the Center Support Leg (8). By using the Bolts (D), Lock Washer (G) with Flat Washer (H) with M4 Allen Wrench (M).

Step 9

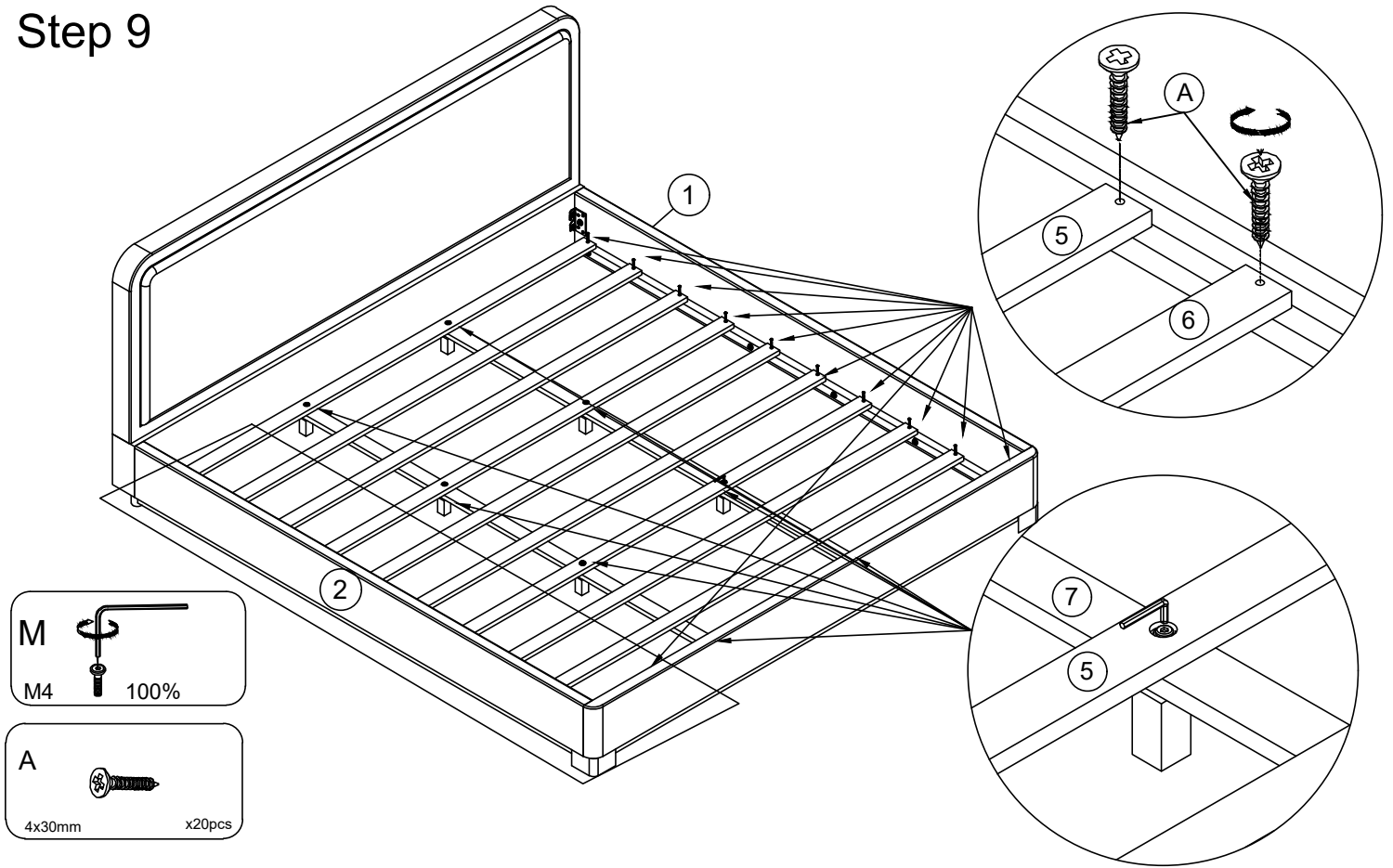

Assemble the Slats with 4 pre-holes (5) and the Slat with 2 pre-holes to the bed Sides Rail (1) and (2). Use screw A. Finally, use the M4 Allen Wrench (M) to tighten the Bolts (D) 100%

Finish

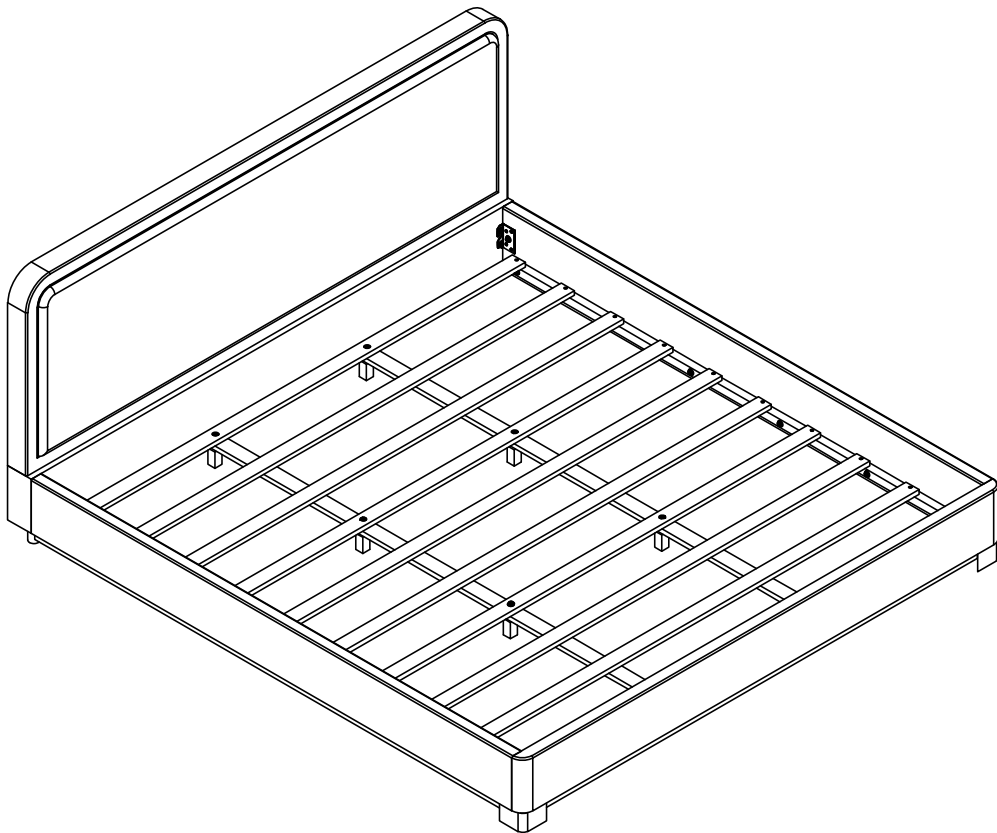

Thank you for your trust and preference in using our products.
The product will bring you a peaceful sleep forever