

Ergonomic Office Chair



CUSTOMER SERVICE

Assembly Instruction

1. Thank you for choosing our office furniture.
2. We hope to provide a more comfortable office space for you to constantly generate inspiration.
3. Please organize all pieces so that you can follow the instruction for smooth assembly.
4. Note to self, don't be so excited and slow down and read the instruction step by step.
5. Clear up enough space for the installation and remove any obstacles in the way.
6. The product could be assembled by one person, but would recommend two.
7. If any problems, please contact us and you will get reply within 24 hours.

1-Year Warranty

We offer 1-year warranty starting from the purchase date during normal use. But if any problem, please contact us and you will get reply within 24 hours.

More Efficient Response

To make us understand the exact problem and solve the problem more effectively. it would be better if you can send us the order ID and attach the pictures or videos illustrating the problems

Problem You May Encounter

Problem	Solution
If you have difficulty installing this product	Contact us for detailed installation video and personalized assistance to ensure successful installation and seamless usage of our product.
Parts are missing, defective, or wrong parts in the package.	Contact us via your order page, and we will respond within 24 hours. Alternatively, you could also contact us through our after sales email

TURN THE PAGE FOR ASSEMBLY MANUAL →

ASSEMBLY INSTRUCTION

DESCRIPTION

① A*1 B*1

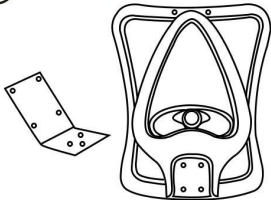

② C*1

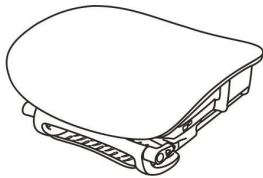

③ D*1

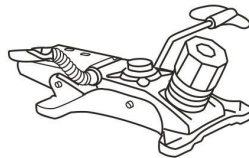

④ E*2

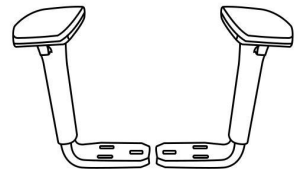

⑤ F*5 G*1 H*1

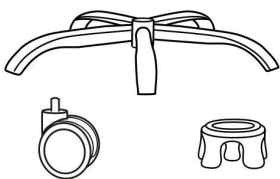

⑥ I*1 J*1

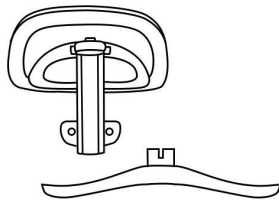

⑦ K*1 L*1

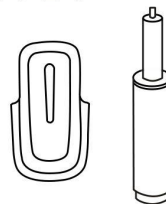

⑧ M M8*20MM/7PCS
N M6*30MM/6PCS
O M6*25MM/6PCS
P M5*1PCS

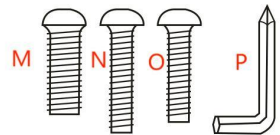

STEPS

①

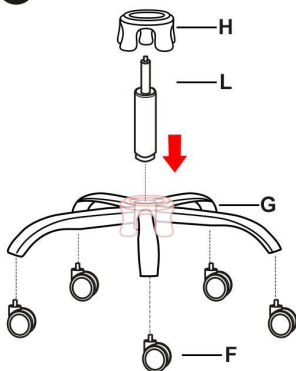

②

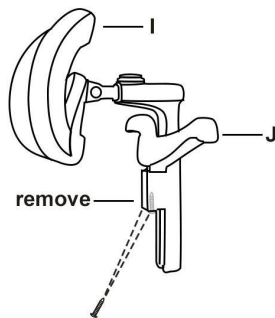

③

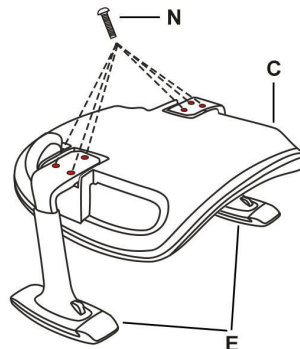

④

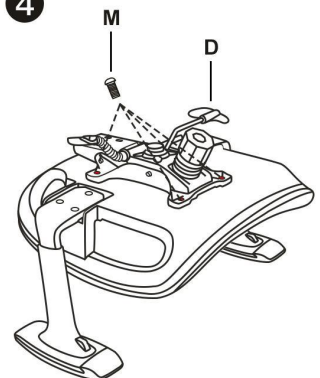

⑤

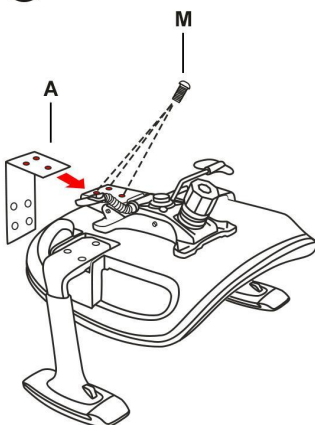

⑥

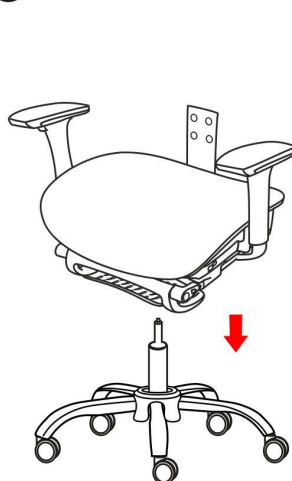

⑦

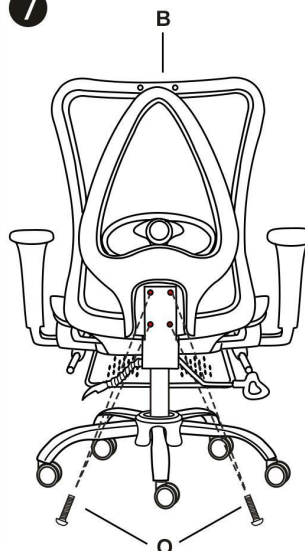

⑧

