

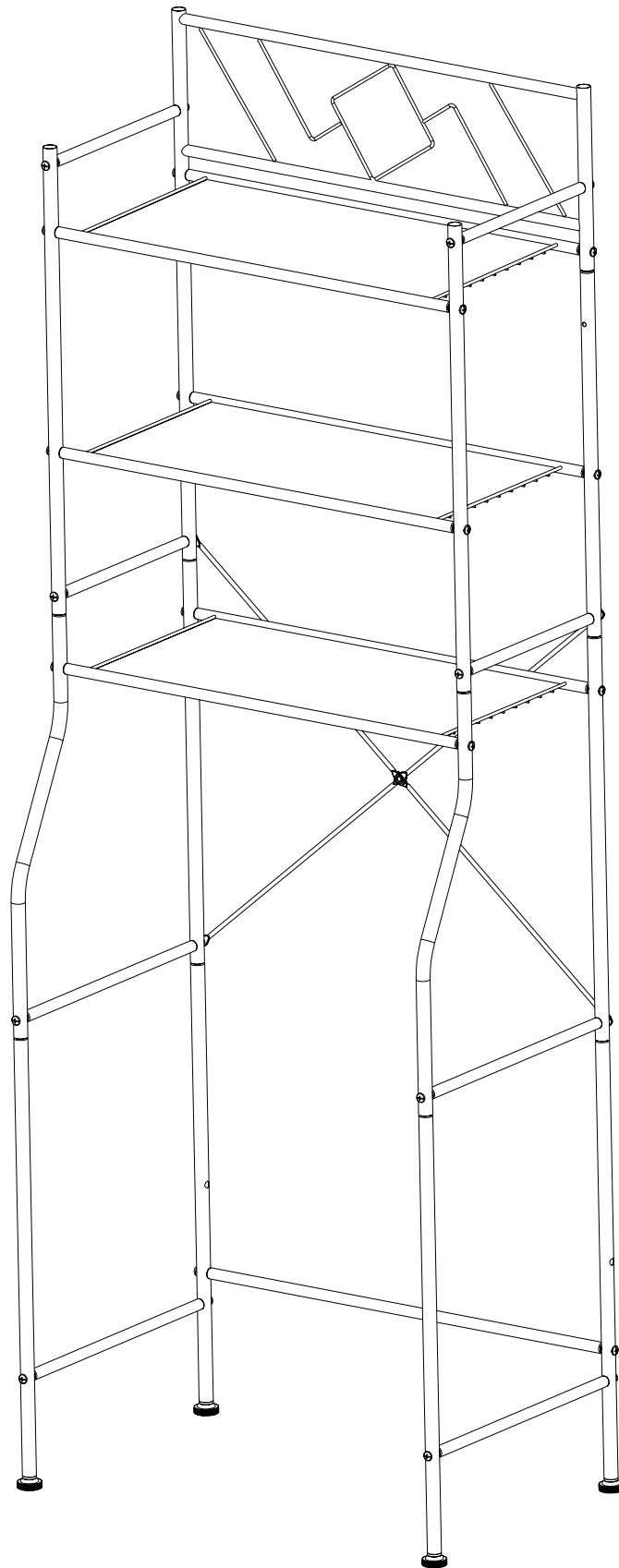

3 Over The Toilet TIER Storage Rack



Questions, concerns, or need replacement parts?

Please contact our Customer Loyalty Team at:
support@homezoneliving.com or 1-866-608-5170
Monday – Friday
8AM – 5PM EST

Model.CAL0124U/CAL0128U
Made In Vietnam

PARTS



A 2x
Rear Bar



B 2x
Front Bar



C 2x
Middle Bars
(all the same)

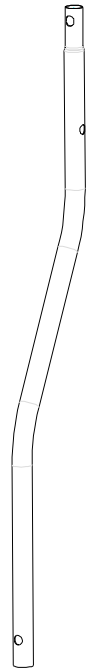

C-1 2x
Middle Bars
(all the same)



D 2x
Bottom Rear Bars



E 2x
Bottom Front Bars

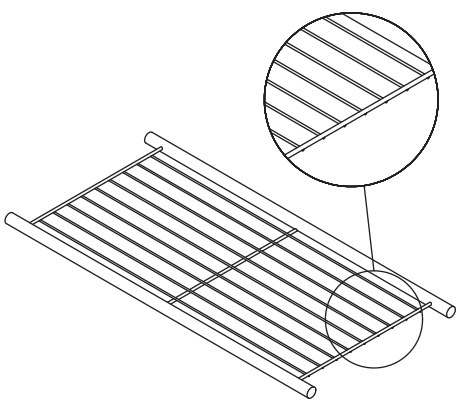

F 3x



I 4x



G 1x



J 4x

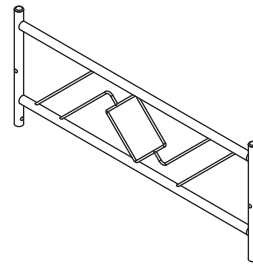

H 1x

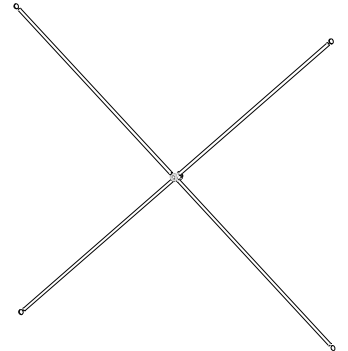

N 1x

Bottom Stabilizer Bar

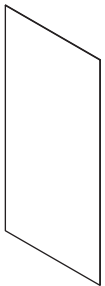

O 3x

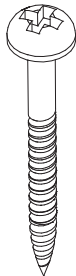

K 2x

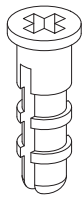

L 2x

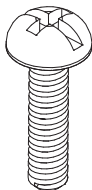

M 30x

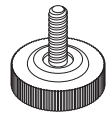

Z 4x

Tools required for installation (not included)



1/4" Drill



#2 Phillips Head Screwdriver



Safety Goggles

WARNING!

- Use caution when drilling into walls to avoid contact with electrical and plumbing lines.
- Test Rite assumes no responsibility for claims arising out of improper installation or handling of products.
- For indoor domestic use only.

CARE & MAINTENANCE

To maintain and protect the fine luster of the bath accessory, clean with a soft, damp cloth only. Do not use scrubbing pads, detergents, or cleansers as they may harm the protective finish of your bath accessory. Always test your solution on a discrete area before applying to the entire surface. Wipe surfaces clean and rinse completely with water immediately after applying cleaner. Do not allow cleaning solution to sit on bathroom accessories.

Step 1 Begin Assembly Of Bottom And Center Sides.
 Leave some thread showing in the screws to allow for easier assembly. (Do not over tighten).
 In Step 3, you will tighten all screws.

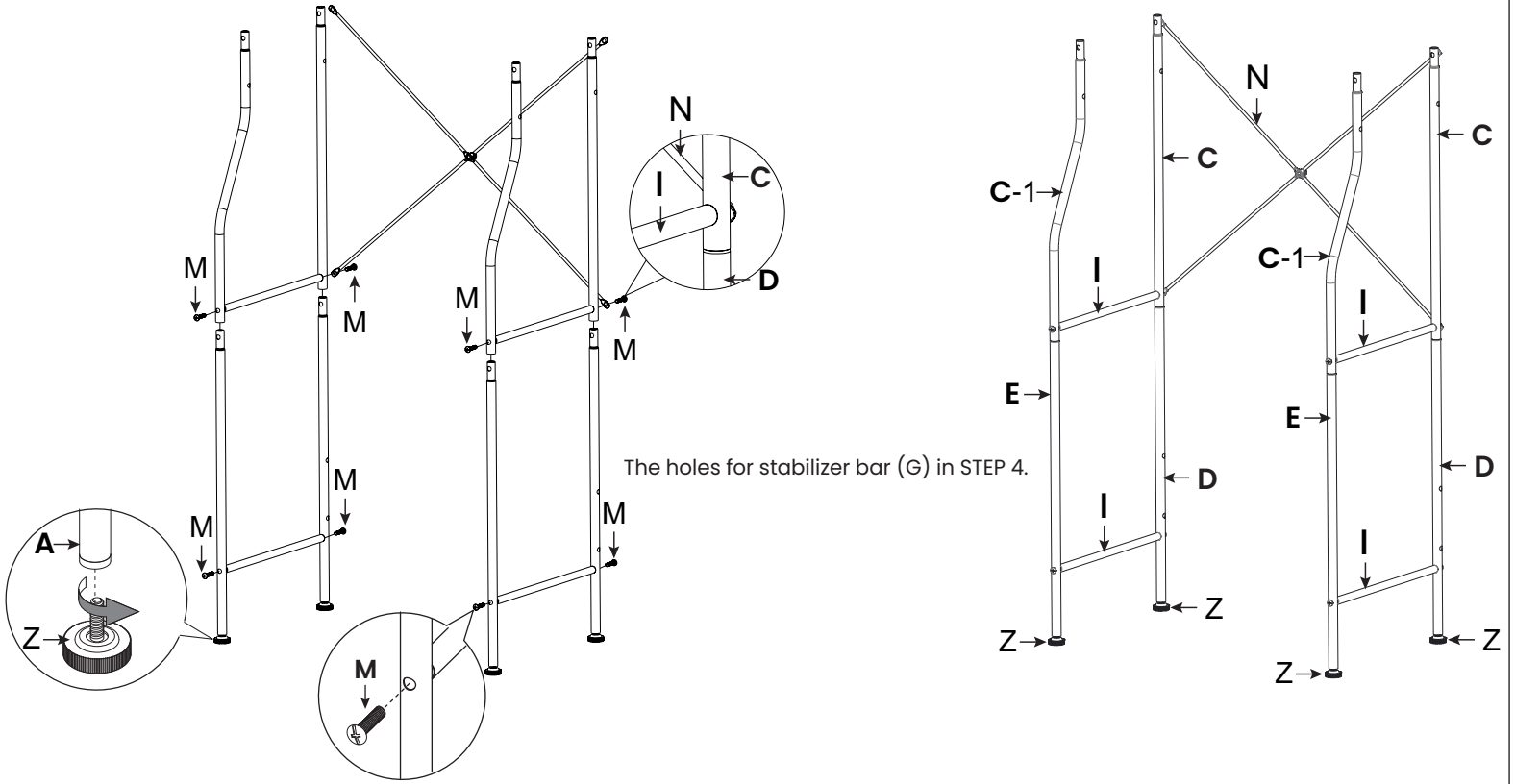

Part D - back pole, 2 holes to connect the side cross bar I and 2 holes for stabilizer bar G (4 holes total)
 Part E - front pole, 2 holes to connect with side cross bar I (2 holes total)

Step 2 Assemble Top Section, Rear Panel (H) and Sides As Shown.

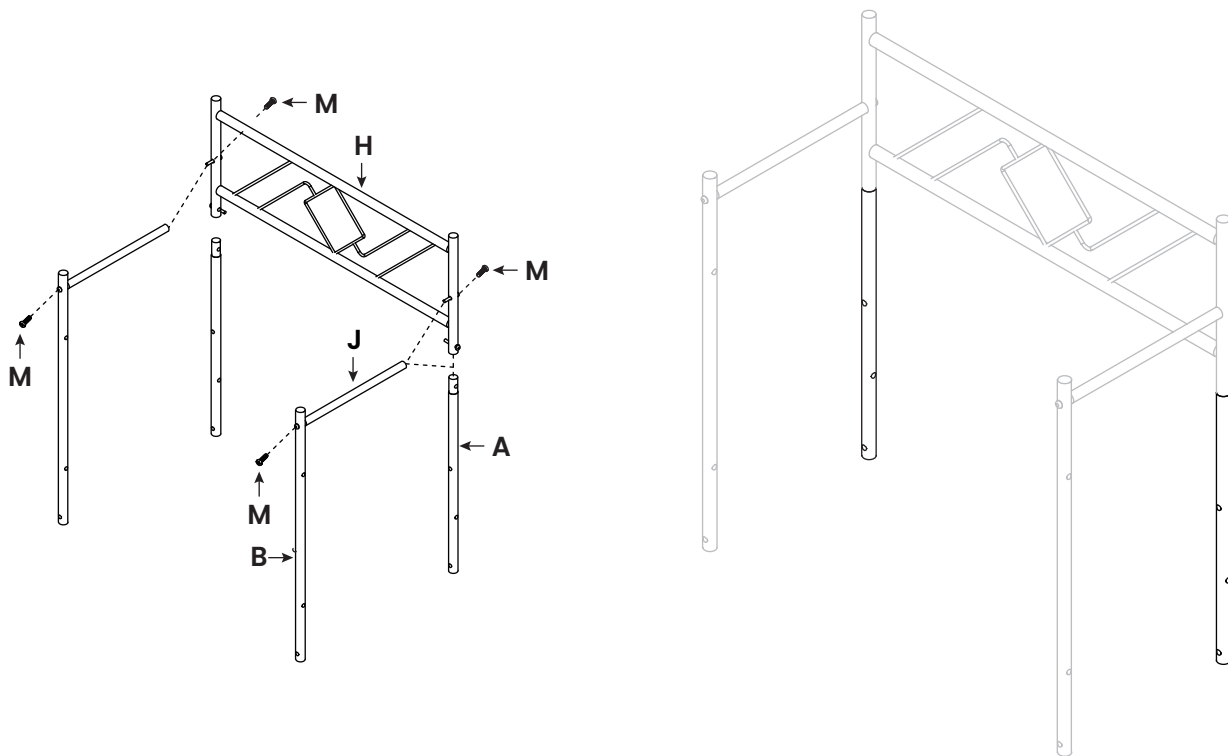

Step 3 Assemble STEP 1 and STEP 2. Mount 3 shelves in predrilled locations. Tighten All Screws.

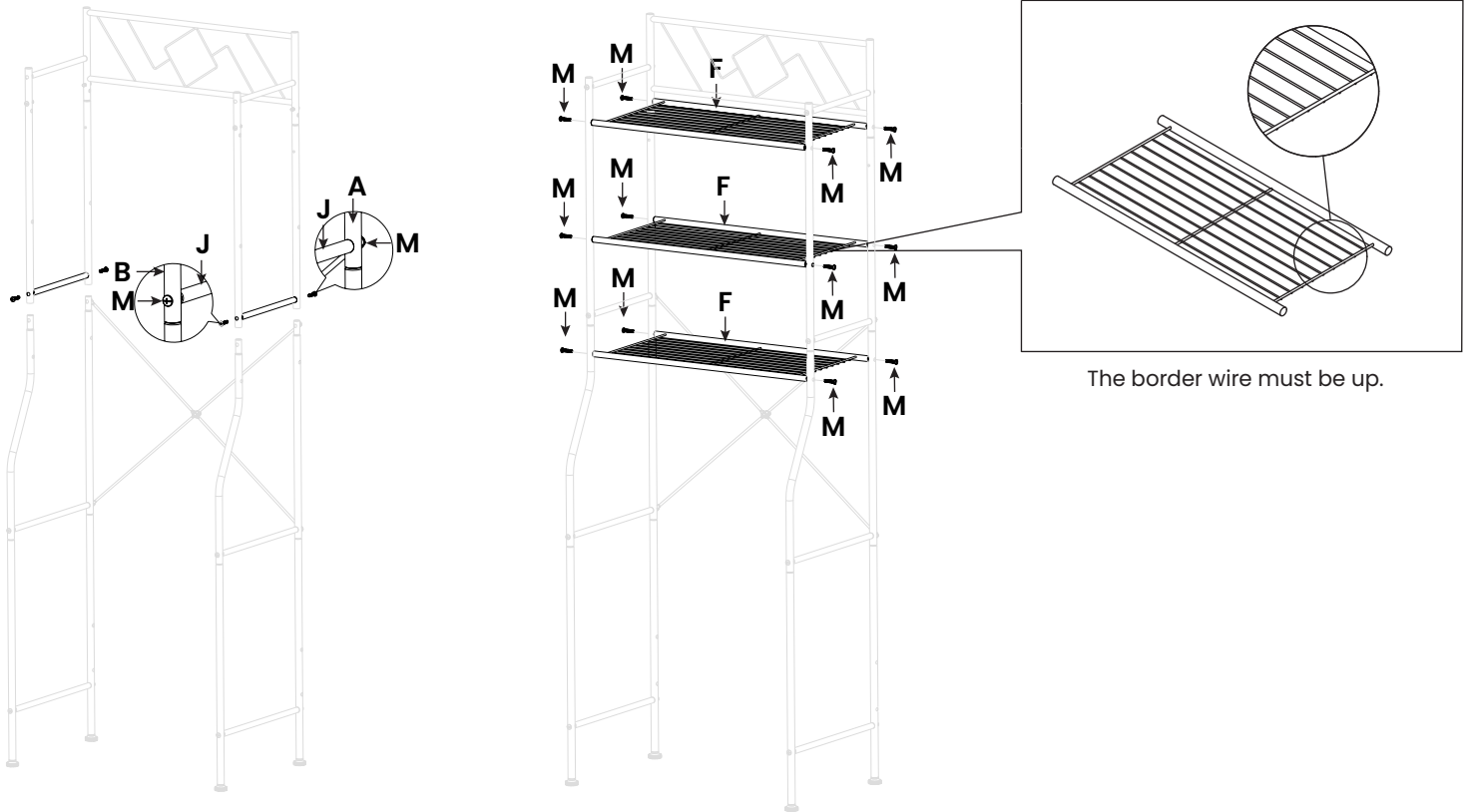

Step 4

STEP 4: Place in position and mark wall mount holes. Drill holes on the marks and insert anchors (L) into the holes. Mount the Space Saver using Screws (K) to the wall. Mount the stabilizer Bar (G) to the frame. NOTE: Two sets of holes are provided (6" and 10" from the floor) to provide options to avoid plumbing.

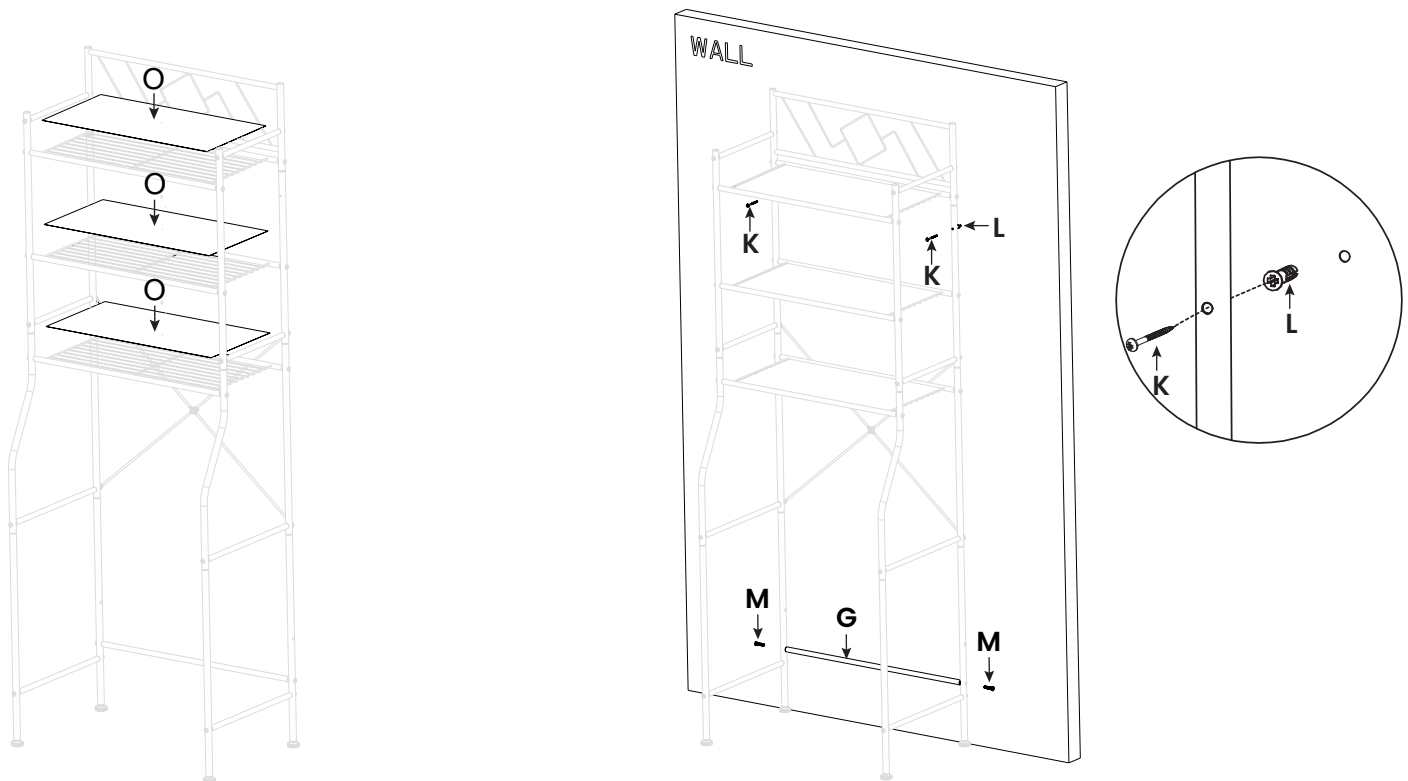

1. Place the Space Saver in the desired location.
2. Attach the support rail G to the bottom side pole D

Distributed by
Horizon Marketing Group, LLC 
4198 Industry Way
Flowery Branch, GA 30542 USA

CA WARNING: This product can expose you to chemicals including Cadmium, Di(2-ethylhexyl)phthalate (DEHP), which are known to the State of California to cause cancer and birth defects or other reproductive harm. For more information go to www.P65Warnings.ca.gov.

Customer Loyalty Team
1-866-608-5170
M - F, 8am - 5pm EST