

ASSEMBLY INSTRUCTIONS

BED - KING

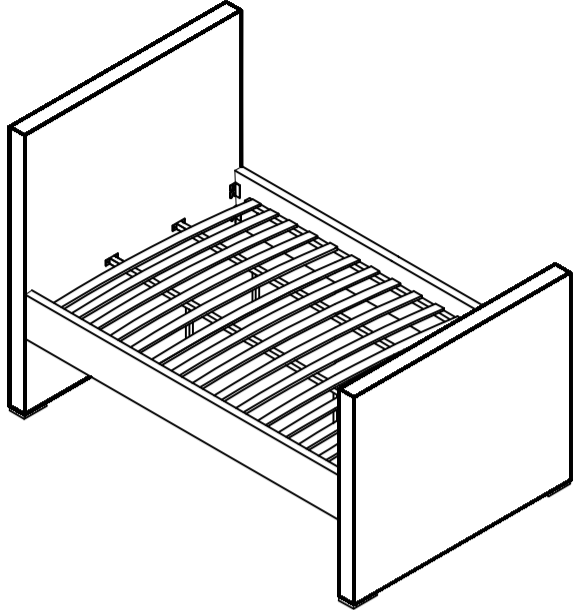

+ Do Not Use Power Tools

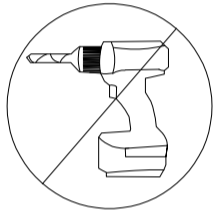

+ Suggested Adults

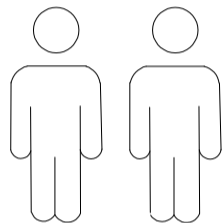

+ Parts Included

① Head Board (1pc)

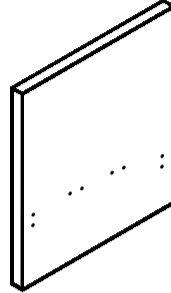

② Foot Board (1pc)

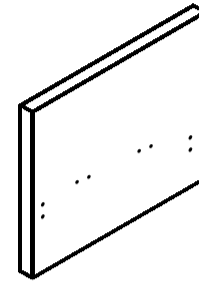

③ Side Rails (2pcs)

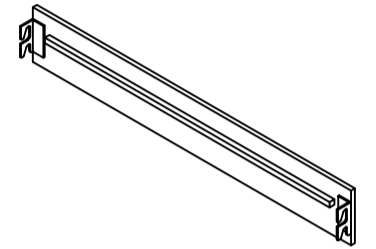

④ Slats joint (1set=13pcs)

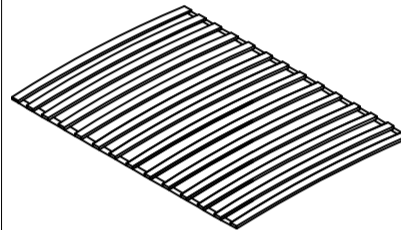

⑤ Center Support Bar (2pcs)

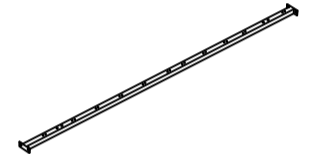

*Slats come packed in the bottom of headboard carton.

⑥ Support Legs (4pcs)



NOTE:

- 1 Read instructions cover to cover.
- 2 Save all packaging until assembly is completed.

1 IMPORTANT SAFETY INFORMATION

Do not assemble the product if any of the following parts arrived damaged:

- Part #③ -Side Rails
- Part #④ -Slats joint
- Part #⑤ -Center Support Bar
- Part #⑥ -Support Legs

2 IMPORTANT ASSEMBLY INFORMATION

Assembly Step ② Ensure the side rail bracket is fully hooked onto bolt **A** loosely threaded with both washers on the **OUTSIDE** of the bracket first, then proceed to fully tightening all 4 corners.

*Slats come packed in the bottom of headboard carton.

+ Hardware Included

A Bolt M8*40mm (24pcs)



C Spring Washer (8pcs)



E Flat Washer $\phi 20$ (24pcs)



F M8 Allen Key (1pc)



I Nut M8*13mm (8pcs)



J Spanner (1pc)

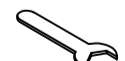

ASSEMBLY INSTRUCTIONS BED - KING

