

Metal Garden Shed

3 Foot x 5 Foot

Assembly Instruction

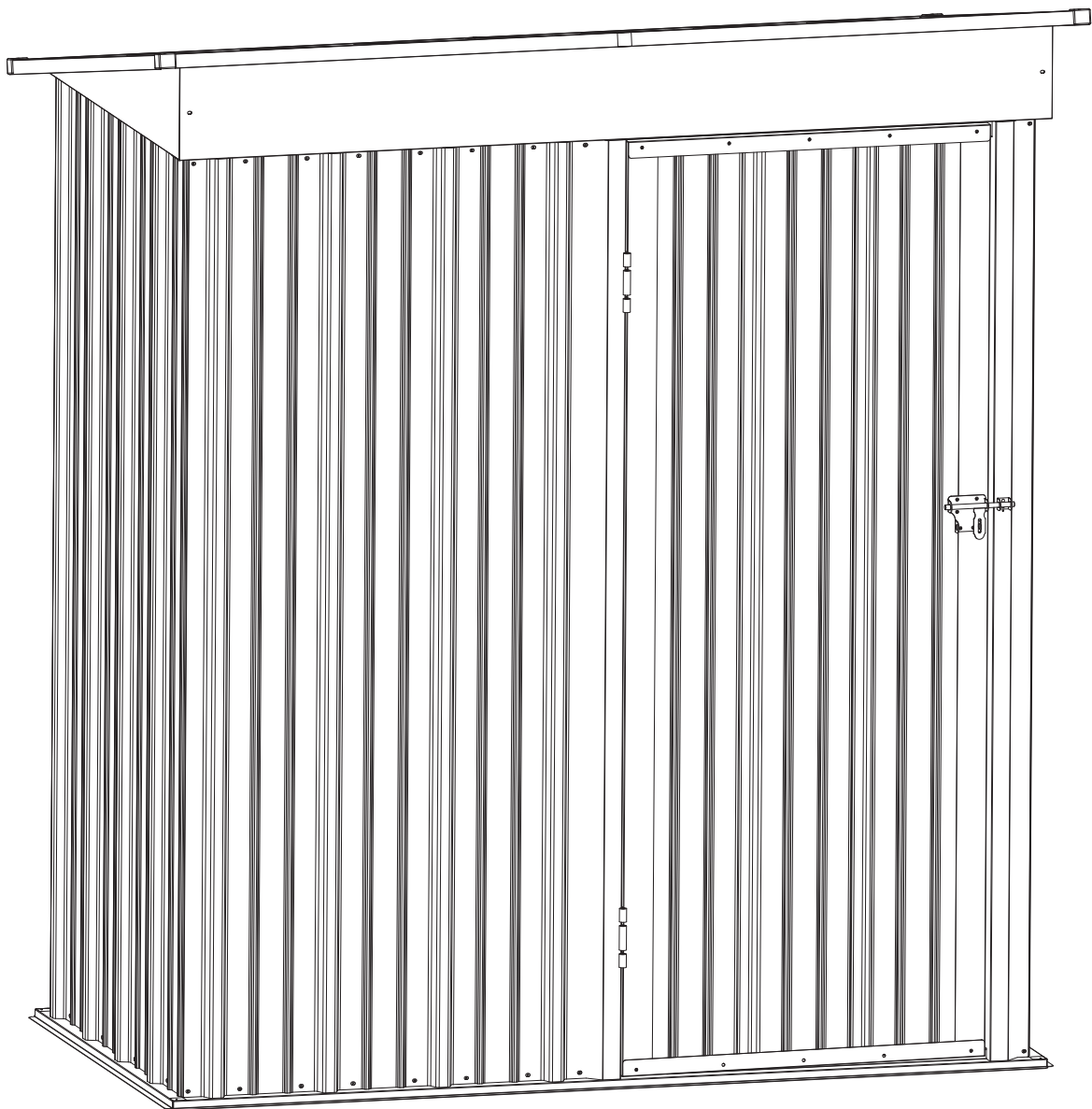

Requires two people and takes 2-3 hours for Installation.
Recommended to wear gloves to avoid scratches

PLAN AHEAD

Before beginning installation, check local building codes regarding footings, location and other requirements.

Study and understand this instruction.

Important information and helpful tips will make your installation easier and more enjoyable.

Tools and Materials: There are some basic tools and materials you will need for the installation. Decide which method of anchoring and the type of foundation you wish to use in order to form a complete list of the materials you will need.

BEFORE YOU BEGIN







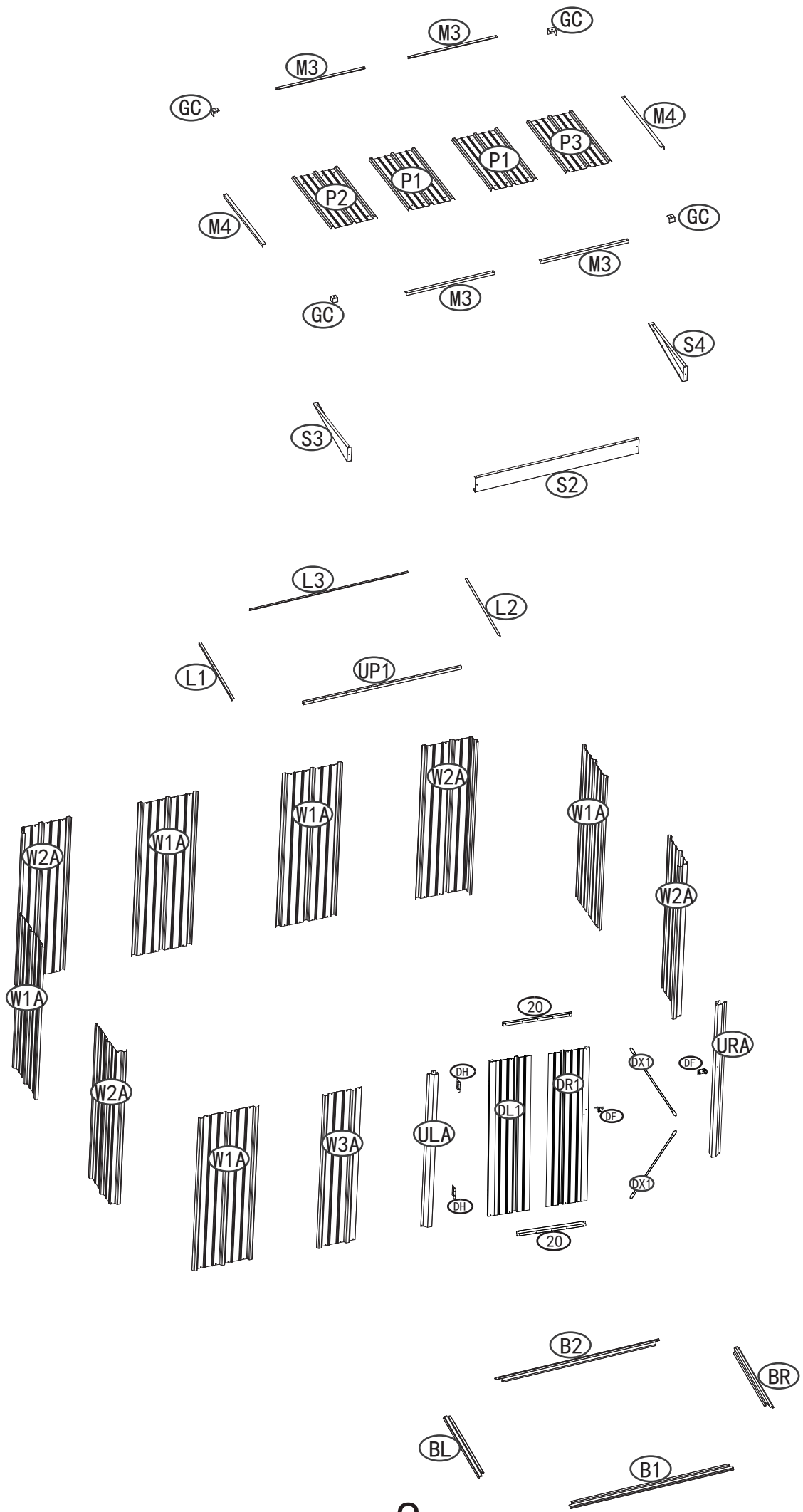











Assembly Instruction: Instructions are supplied in this manual and contain all appropriate information for your installation. Review all instructions before you begin, and during assembly, follow the step sequence carefully for correct results.













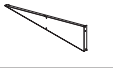



Parts List: Check to be sure that you have all the necessary parts and quantities in your package. These are packaged within the carton. Note that extra fasteners have been supplied for your convenience.



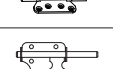

Explosion Diagram: All parts except screws and bolts are shown in this diagram, review all parts before you begin. Familiarize yourself with the hardware and fasteners for easier use during installation.







PARTS LIST

PART	NO.	Qty.
	B1	1
	B2	1
	BL	1
	BR	1
	L1	1
	L2	1
	L3	1
	UP1	1
	M3	4
	M4	2
	W1A	5
	W2A	4
	W3A	1
	ULA	1
	URA	1
	20	2
	DL1	1
	DR1	1

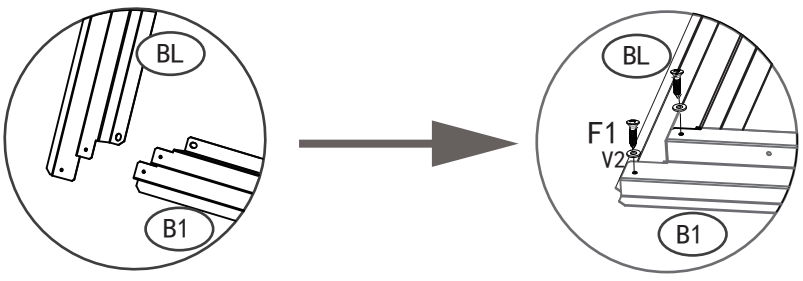
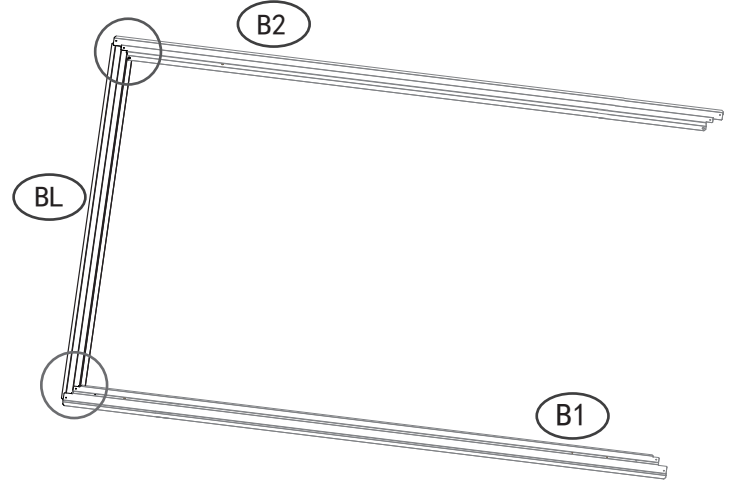
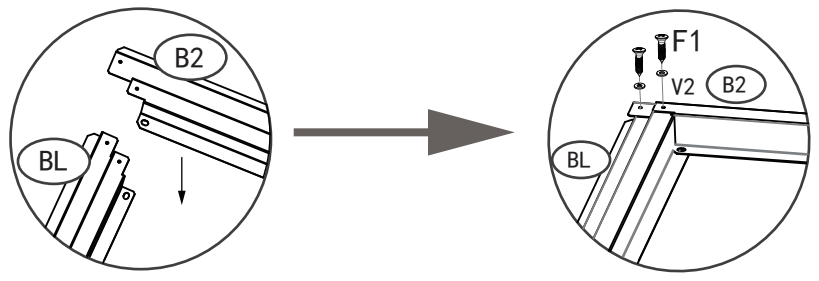

PART	NO.	Qty.
	S2	1
	S4	1
	S3	1
	P1	2
	P2	1
	P3	1
	GC	4
	F1	163
	F2	8
	F3	16
	V2	149
	V1	122
	DF	1
	DX1	2
	DH	2
	DG	1
	F6	4
		1

PART	NO.	Qty.
	B1	1
	B2	1
	BL	1
	F1	4
	V2	4



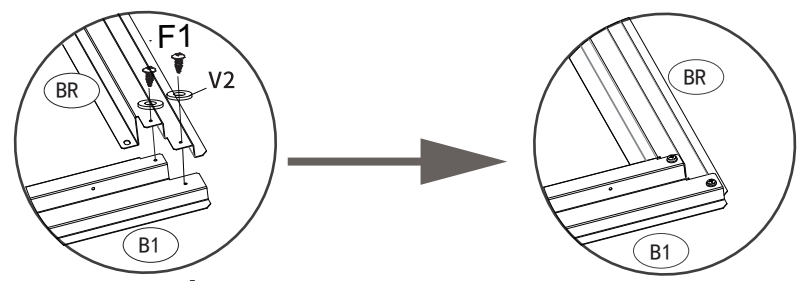
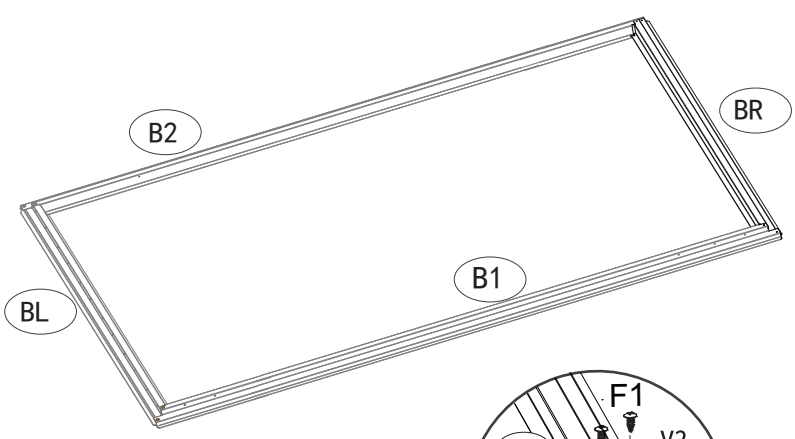
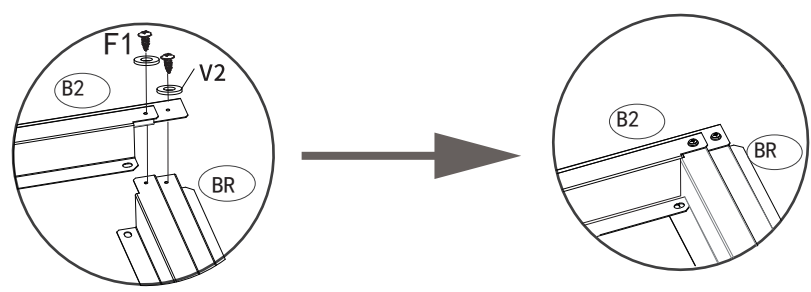

PART	NO.	Qty.
	BR	1
	F1	4
	V2	4



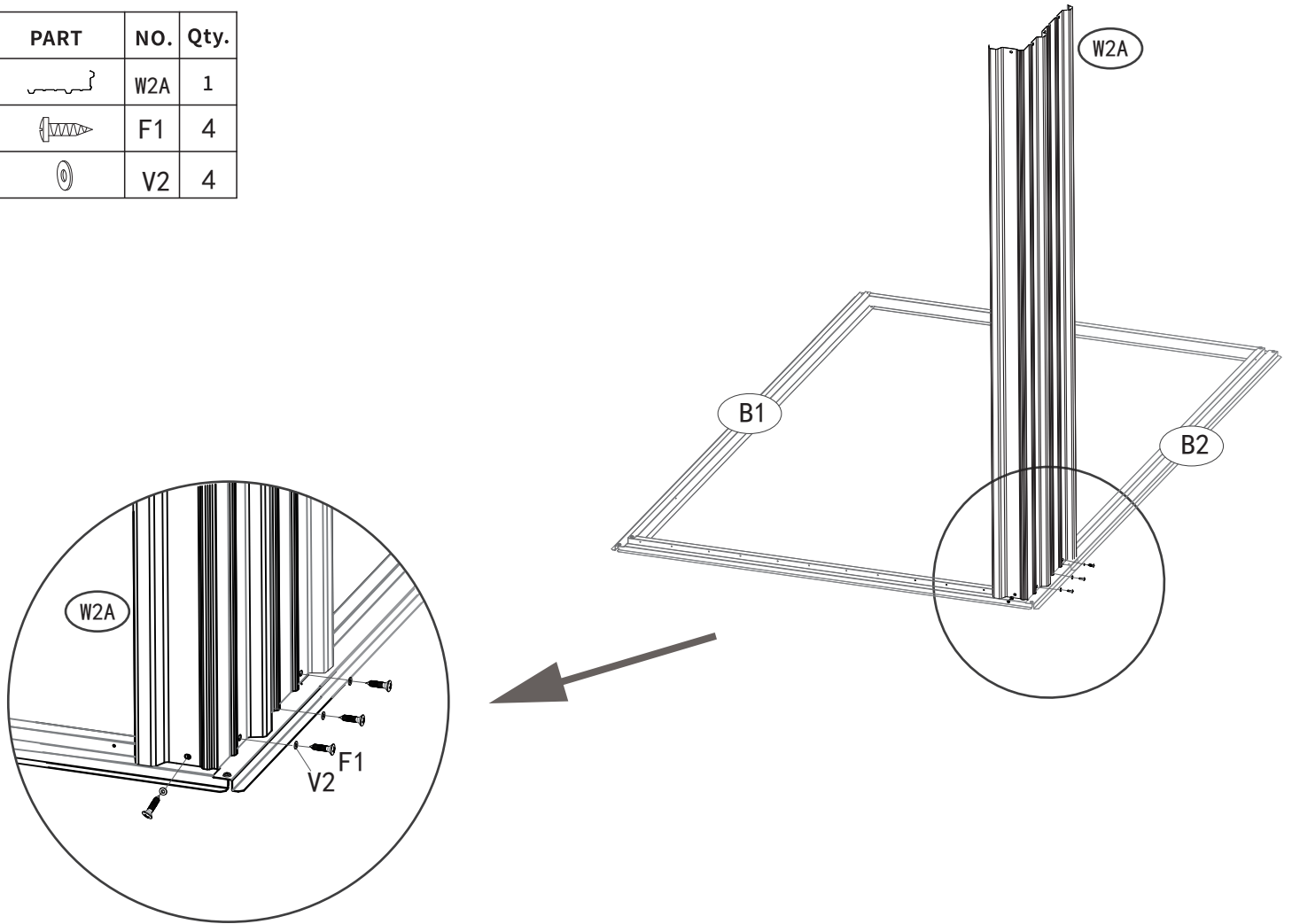

PART	NO.	Qty.
	W2A	1
	F1	4
	V2	4



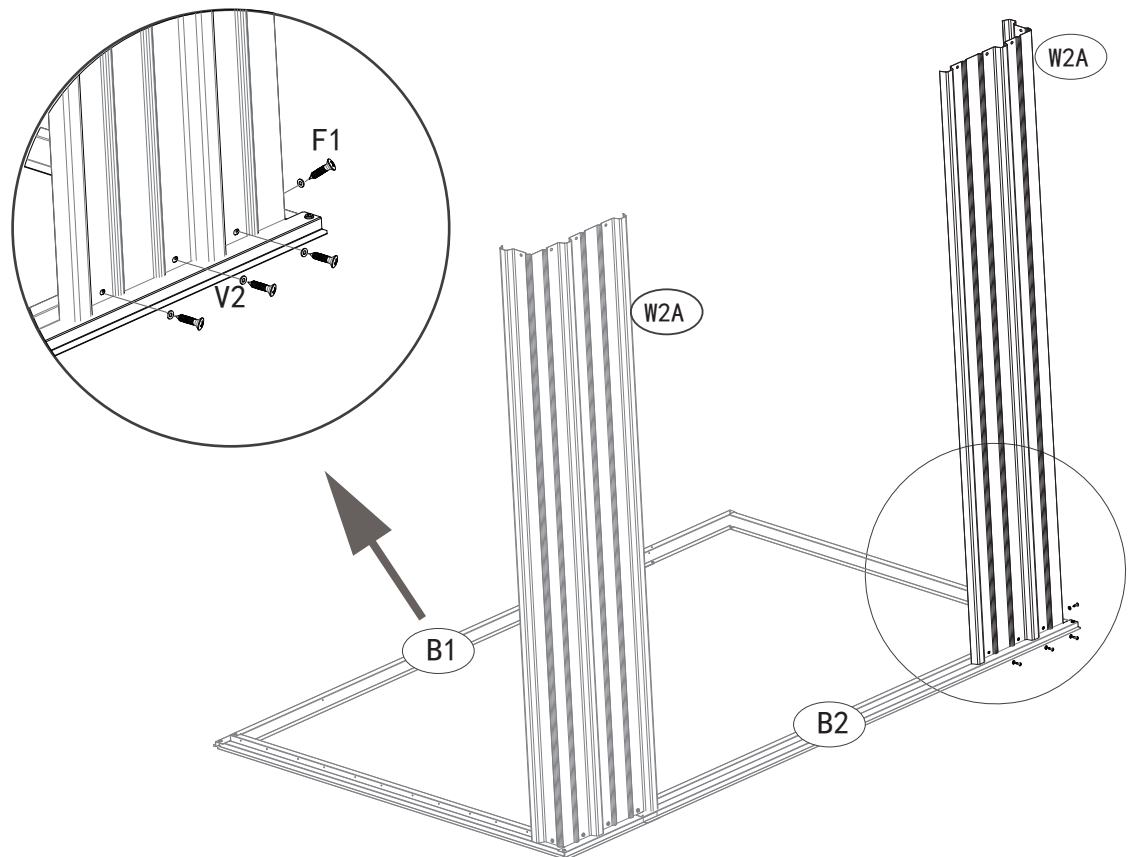

PART	NO.	Qty.
	W2A	1
	F1	4
	V2	4



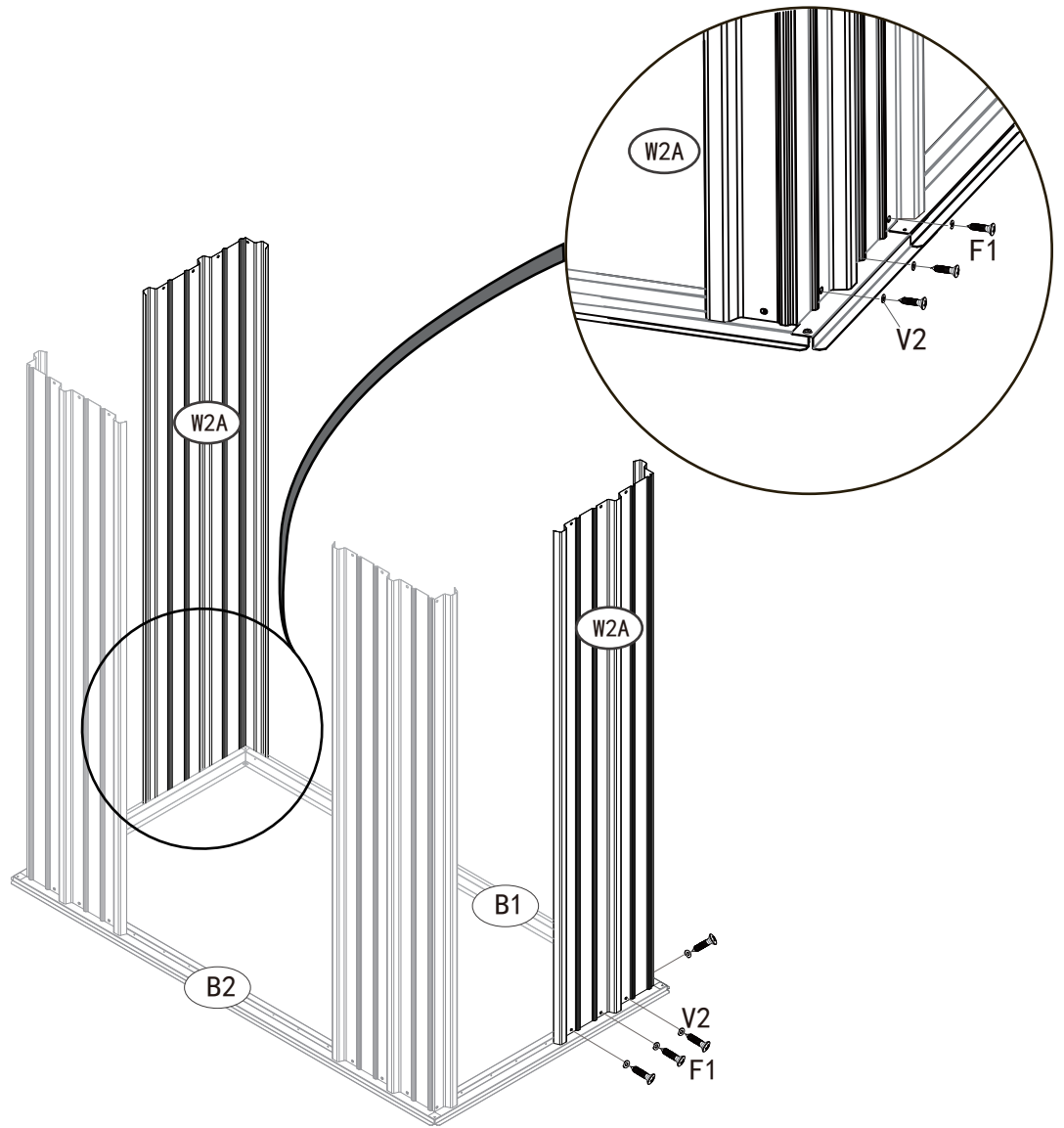



PART	NO.	Qty.
	W2A	2
	F1	8
	V2	8



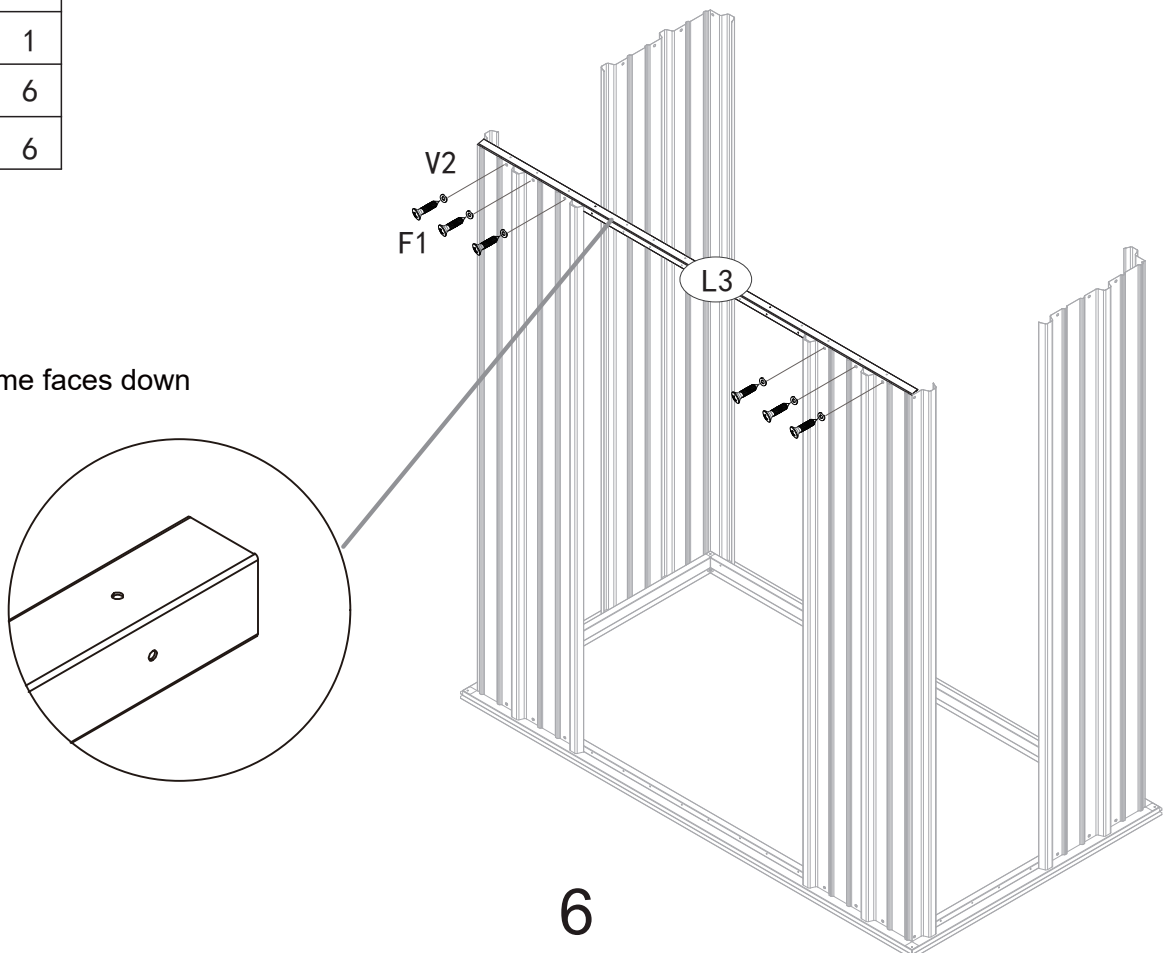



PART	NO.	Qty.
	L3	1
	F1	6
	V2	6

the frame faces down

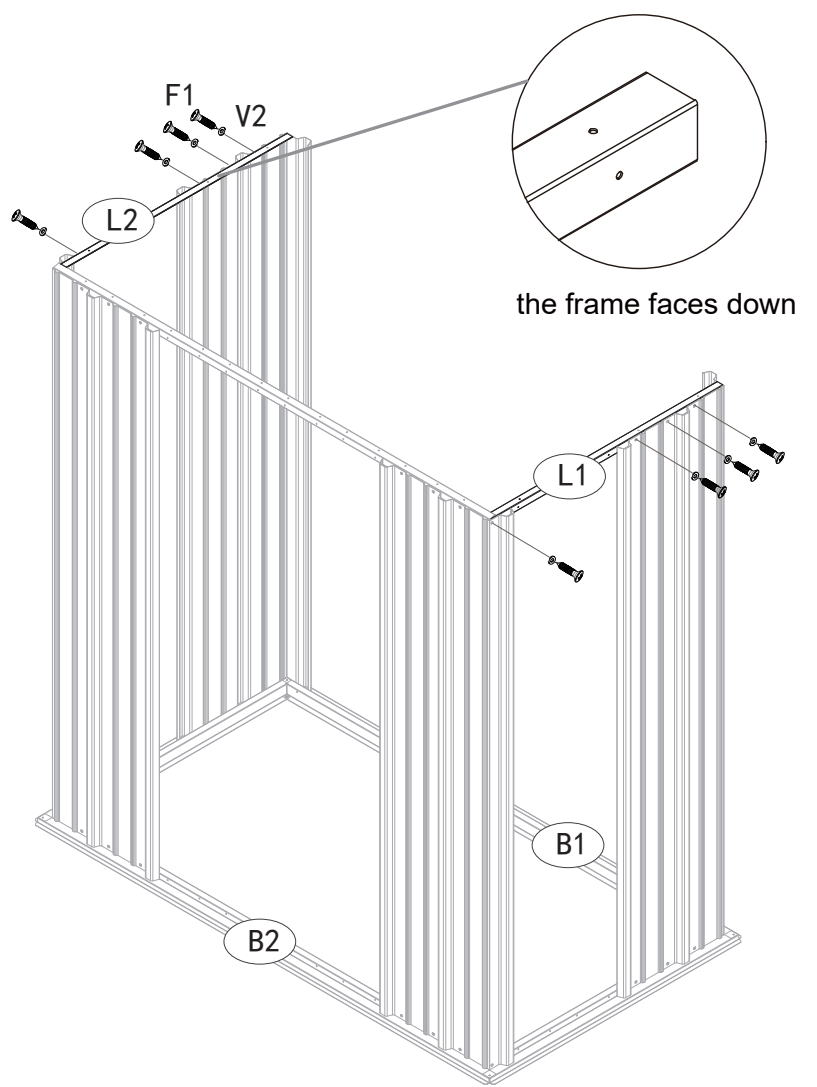



PART	NO.	Qty.
	L1	1
	L2	1
	F1	8
	V2	8



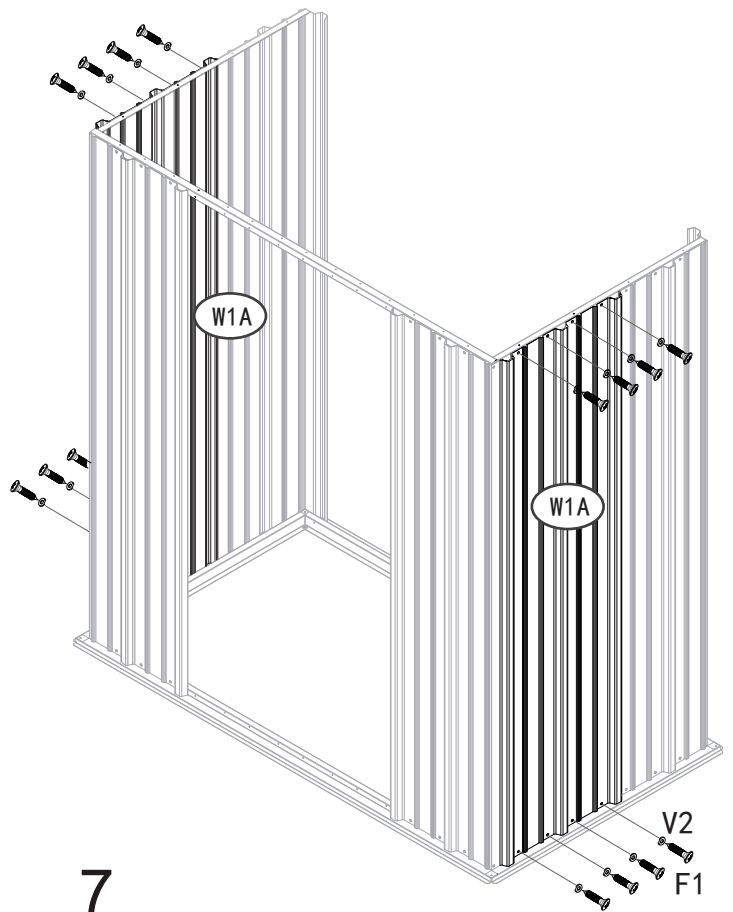

PART	NO.	Qty.
	W1A	2
	F1	16
	V2	16



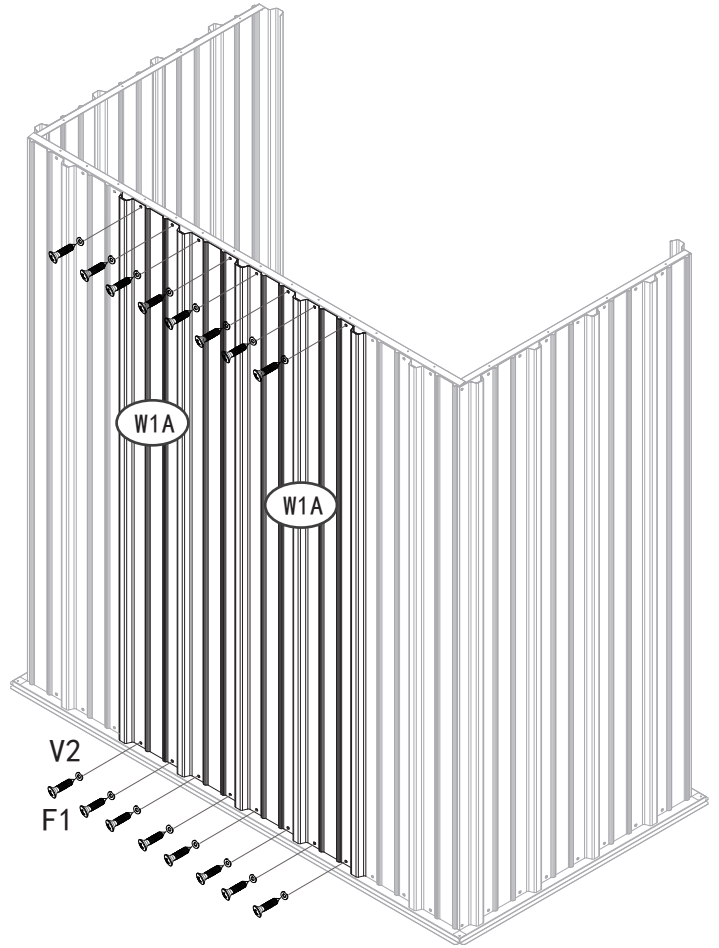

PART	NO.	Qty.
	W1A	2
	F1	16
	V2	16



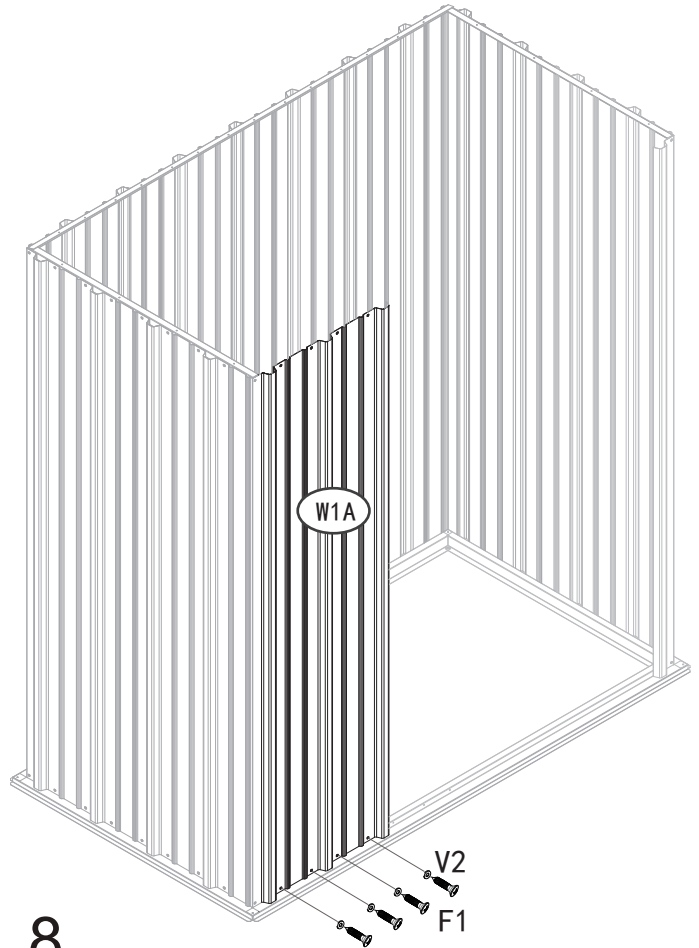

PART	NO.	Qty.
	W1A	1
	F1	4
	V2	4



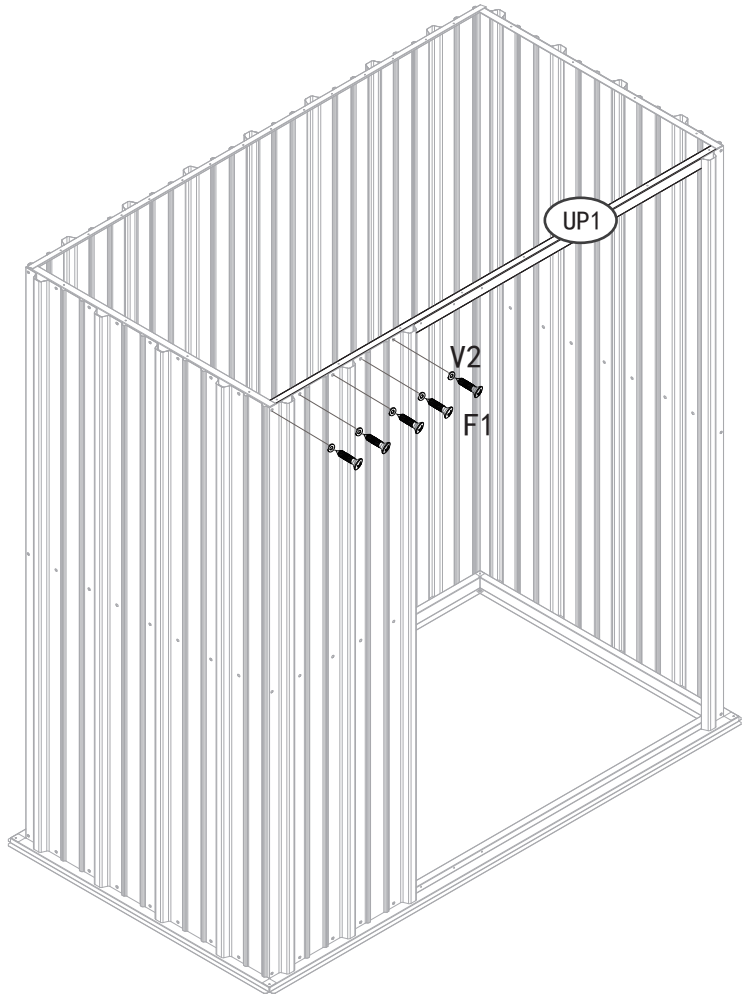



PART	NO.	Qty.
	UP1	1
	F1	5
	V2	5

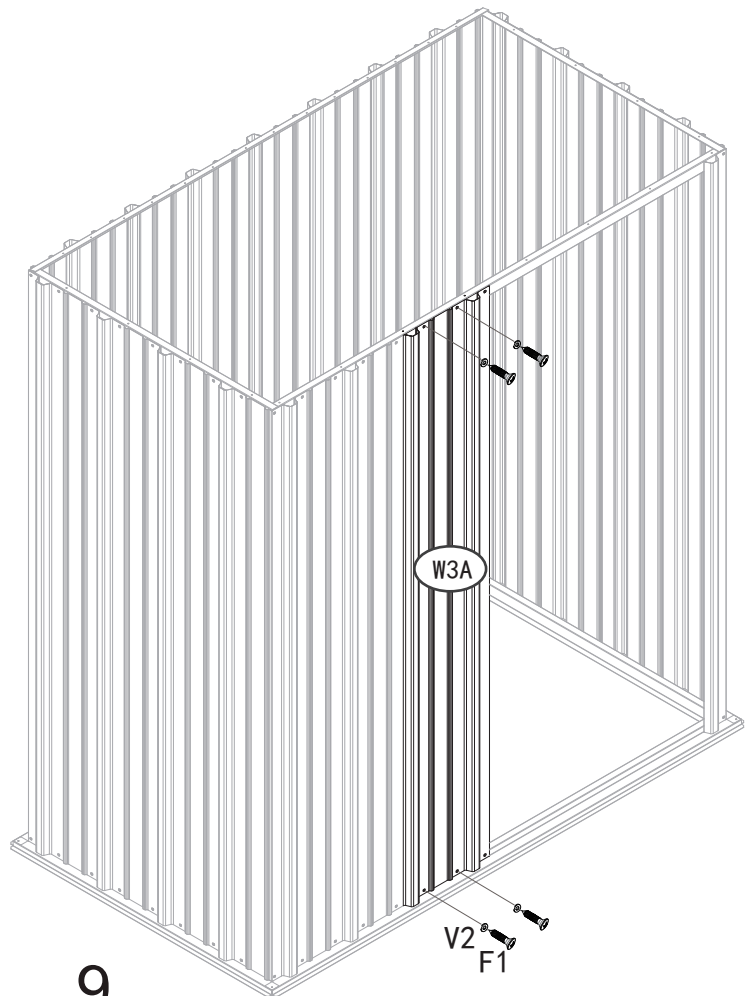

PART	NO.	Qty.
	W3A	1
	F1	4
	V2	4



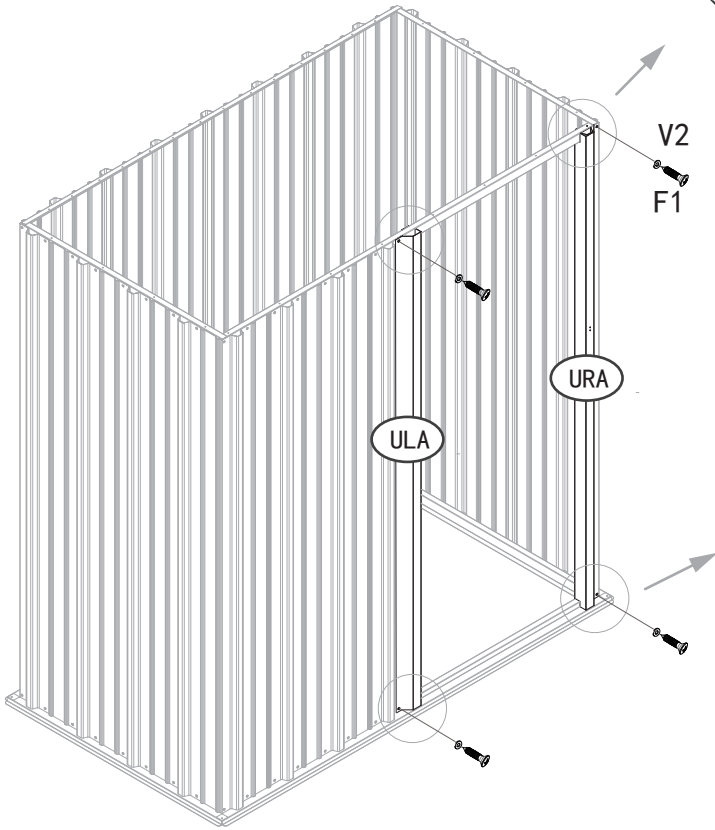
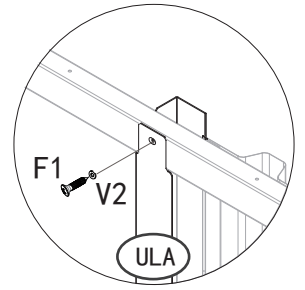
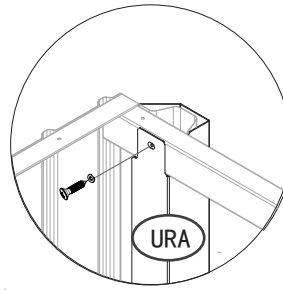

PART	NO.	Qty.
	URA	1
	ULA	1
	F1	8
	V2	8



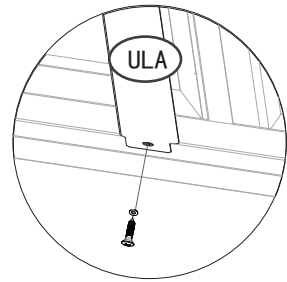
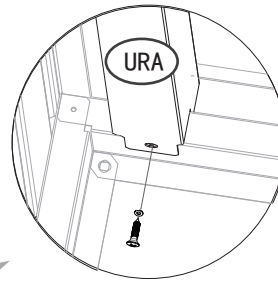



Please pay attention to the assembling way of roof panels!

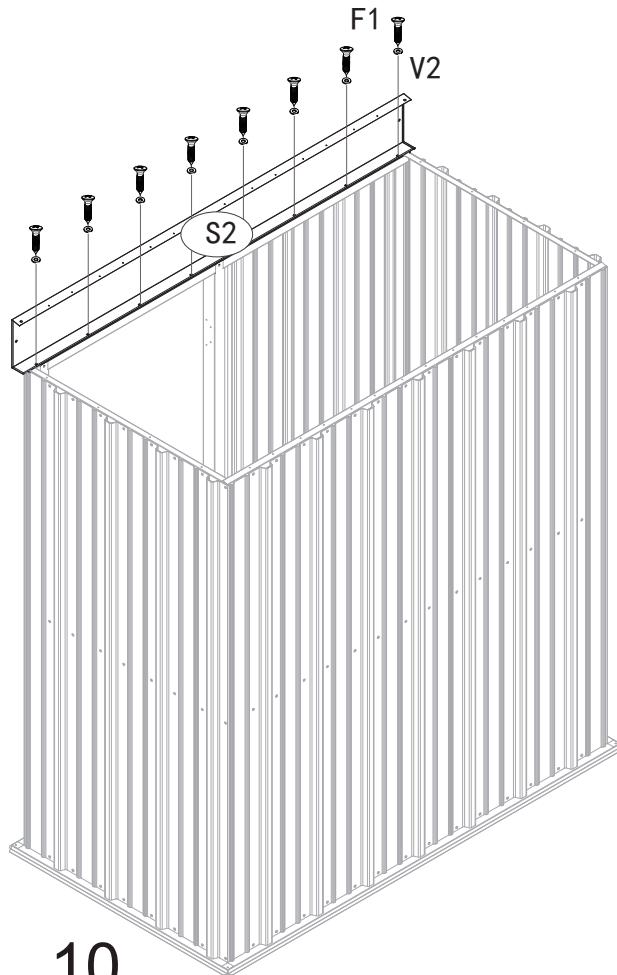





PART	NO.	Qty.
	S2	1
	F1	8
	V2	8

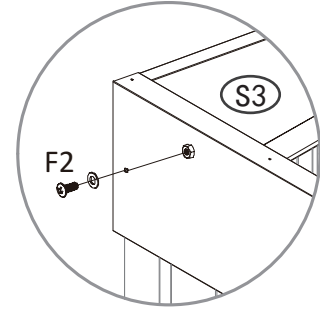
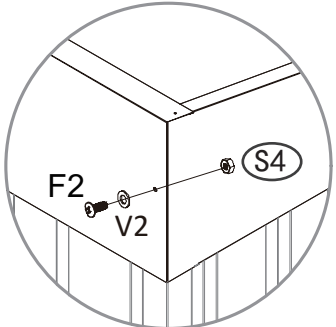
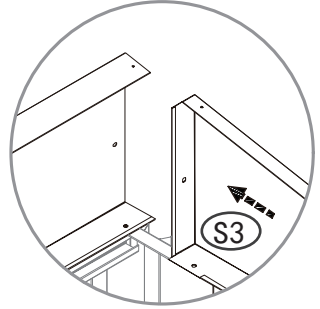
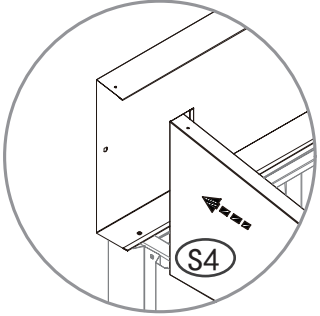
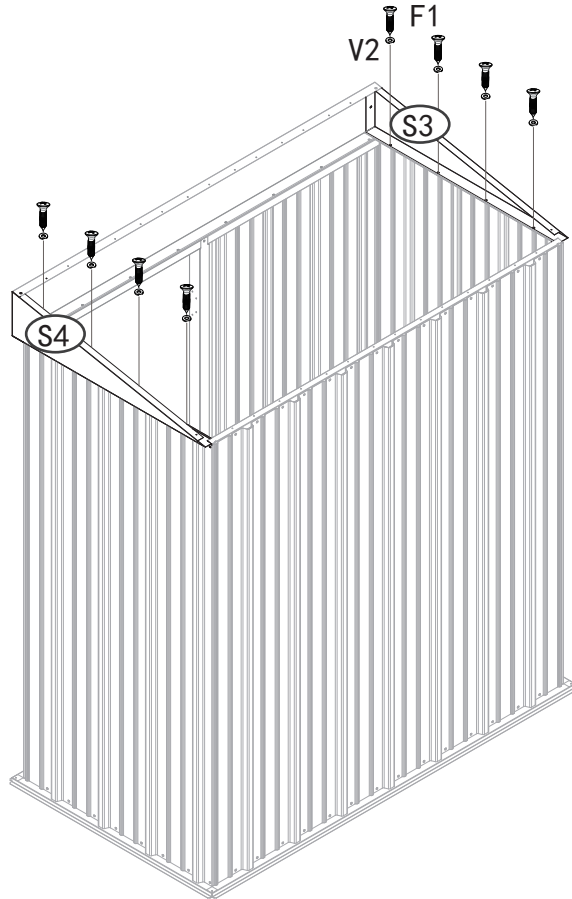

PART	NO.	Qty.
	S3	1
	S4	1
	F1	8
	V2	10
	F2	2



PART	NO.	Qty.
	P1	2
	P2	1
	P3	1
	F1	32
	V2	32

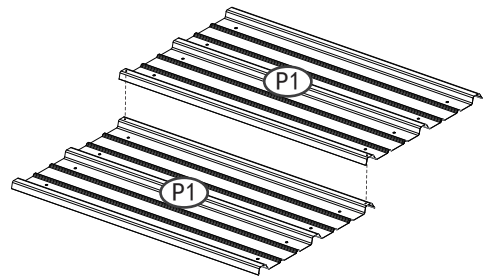
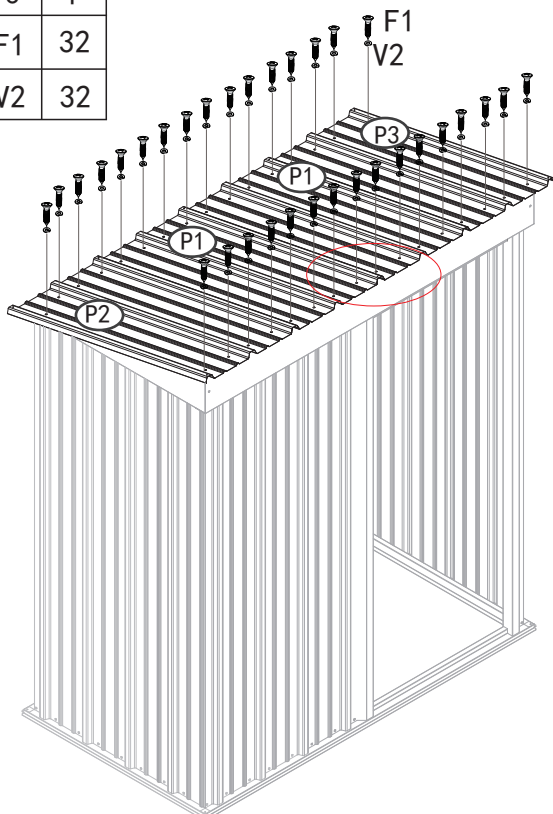

Please pay attention to assembling way of roof panels!

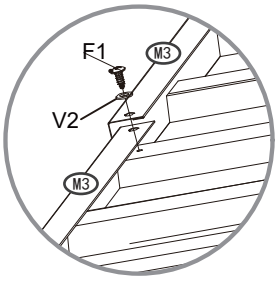



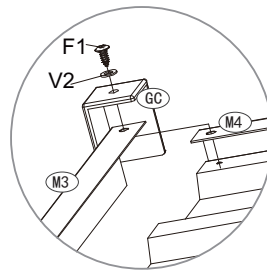

x2

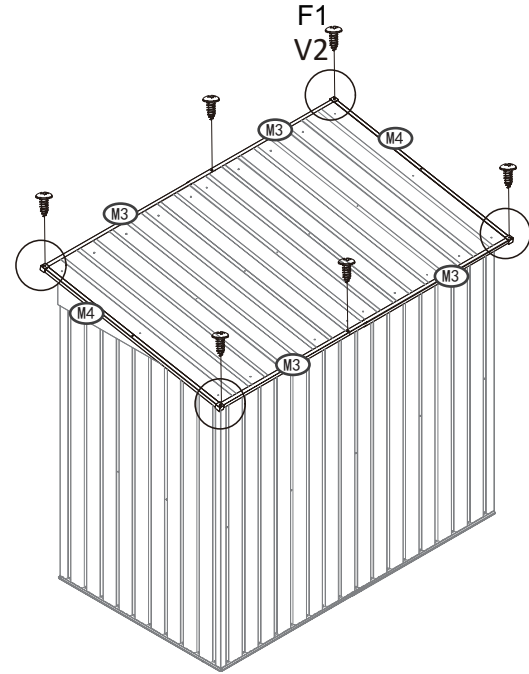
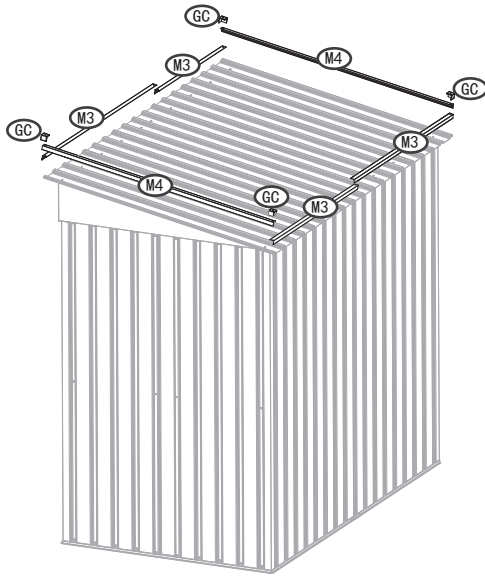





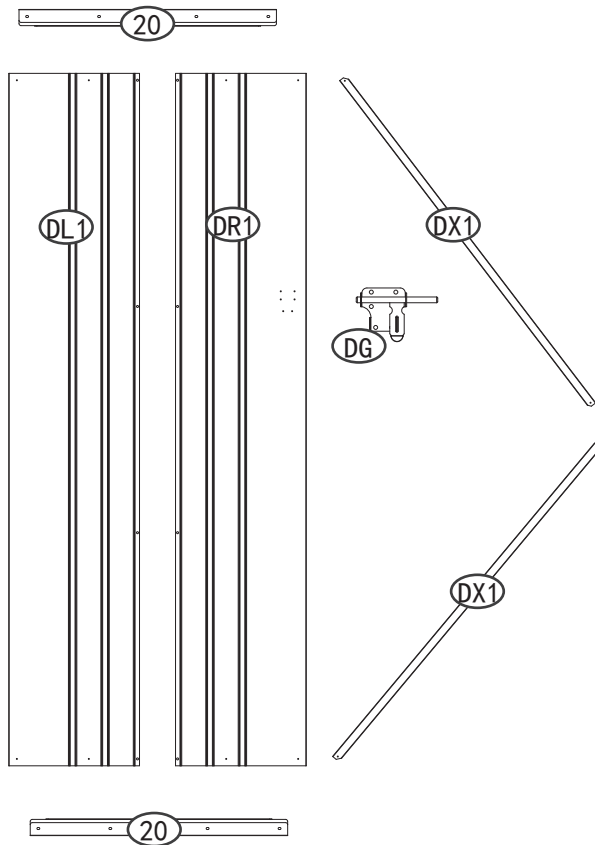

x4





PART	NO.	Qty.
	M3	4
	M4	2
	GC	4
	F1	8
	V2	8

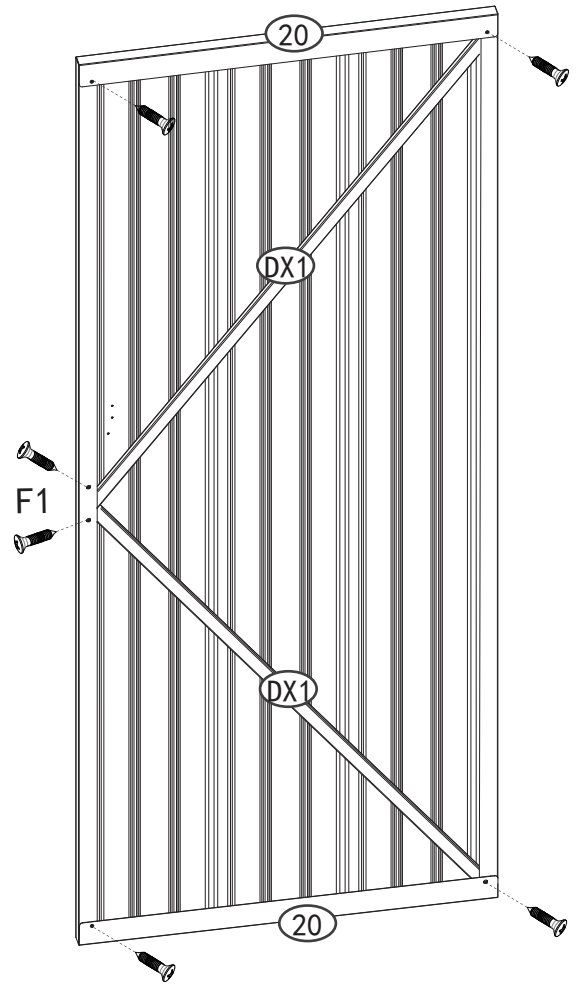
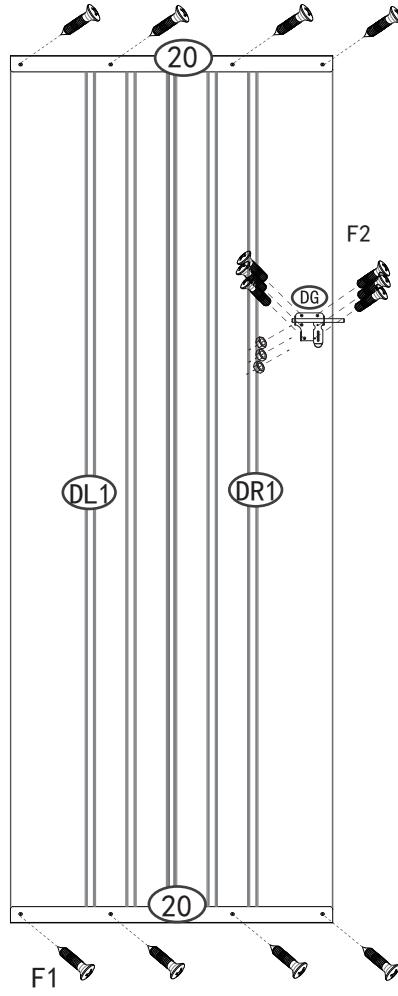

PART	NO.	Qty.
	DX1	2
	20	2
	DL1	1
	DR1	1
	DG	1
	F1	14
	F2	6



PART	NO.	Qty.
	DH	2
	F3	8

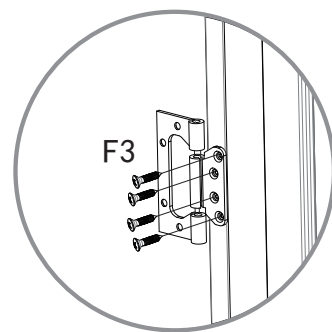
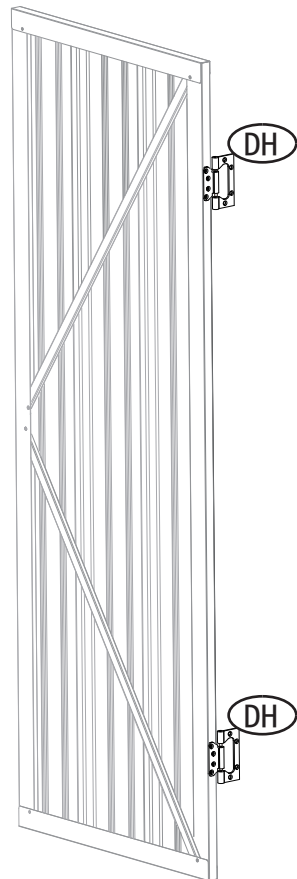



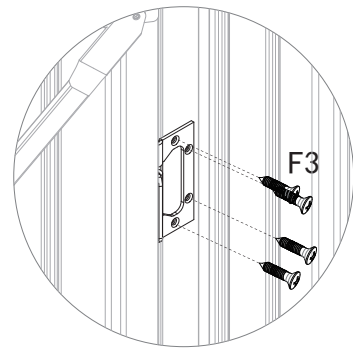
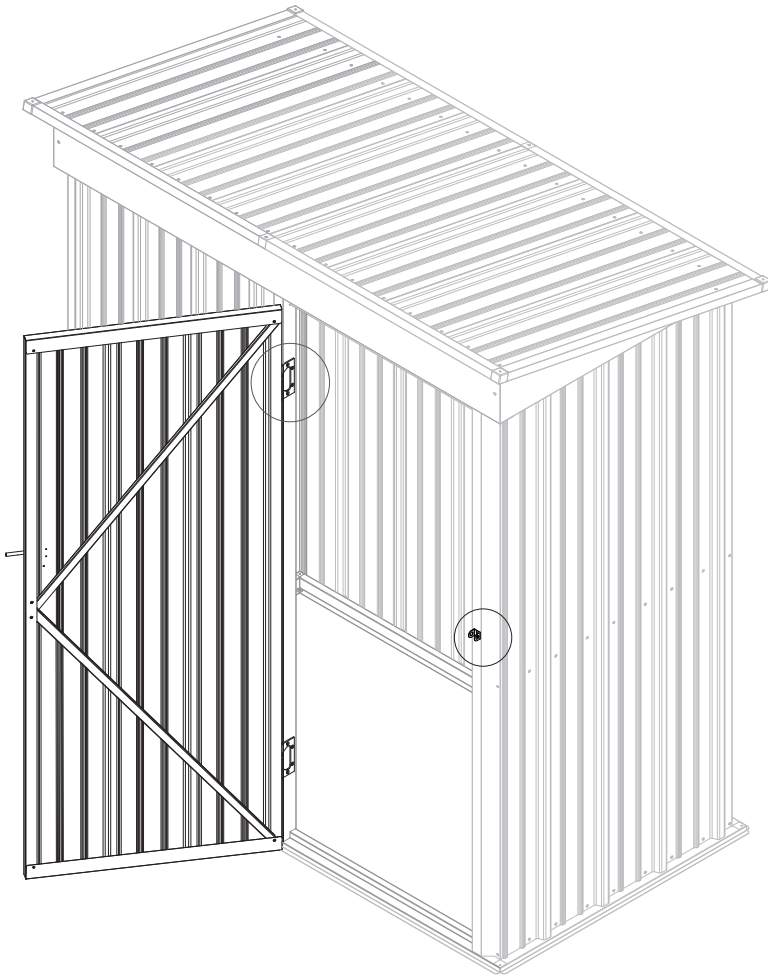

X2

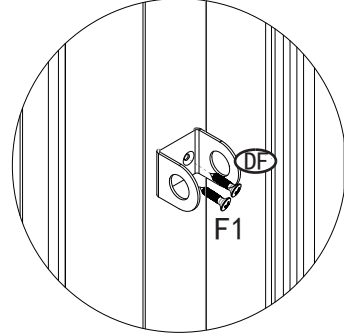



X2

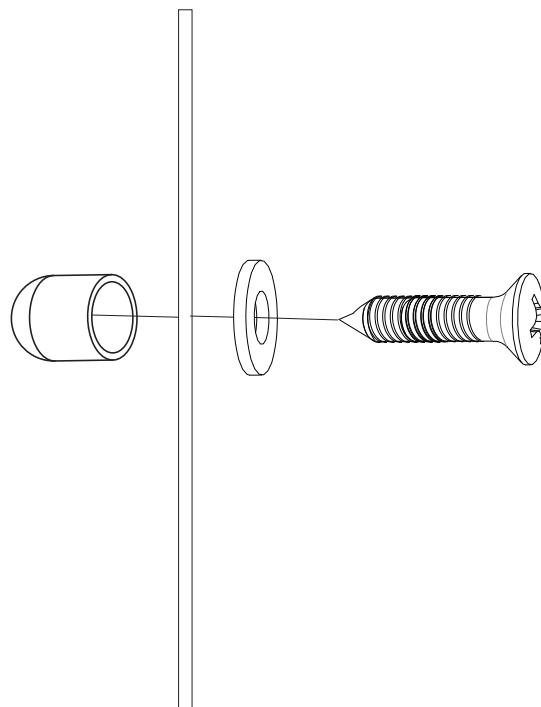

PART	NO.	Qty.
	DF	1
	F3	8
	F1	2

PART	NO.	Qty.
	V1	122



PART	NO.	Qty.
	F6	4

