

Upholstered Office Chair



ASSEMBLY INSTRUCTION

A ×5



B ×1



C ×1



D ×1

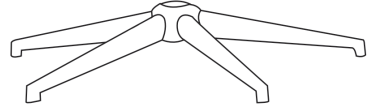

1

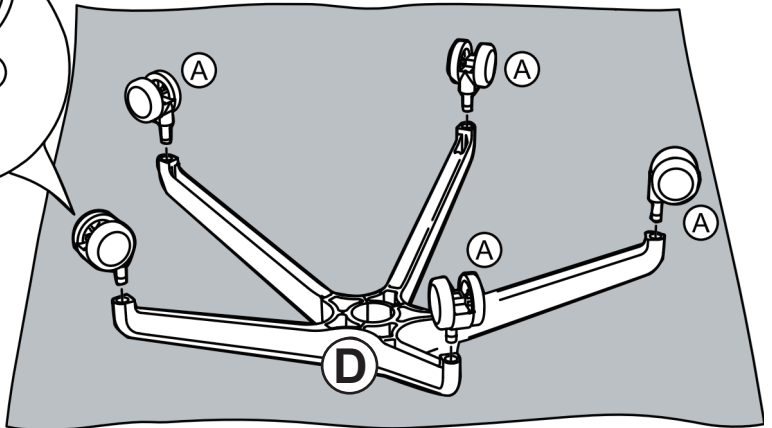
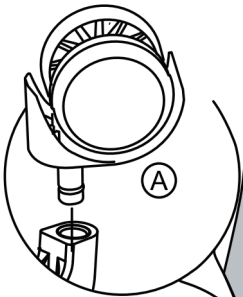
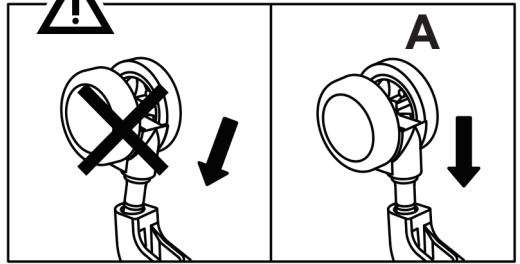

2

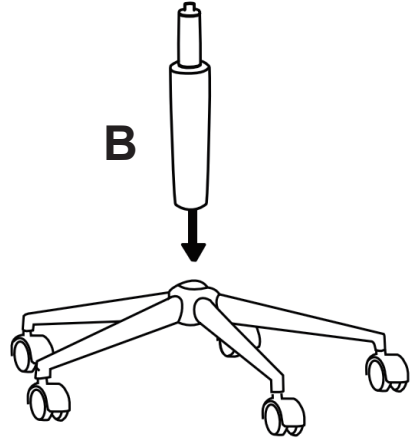
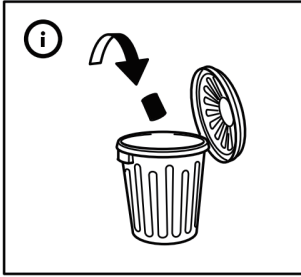
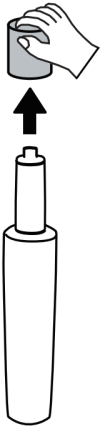

Take off the gas lift protector cap and throw into trash can.

3

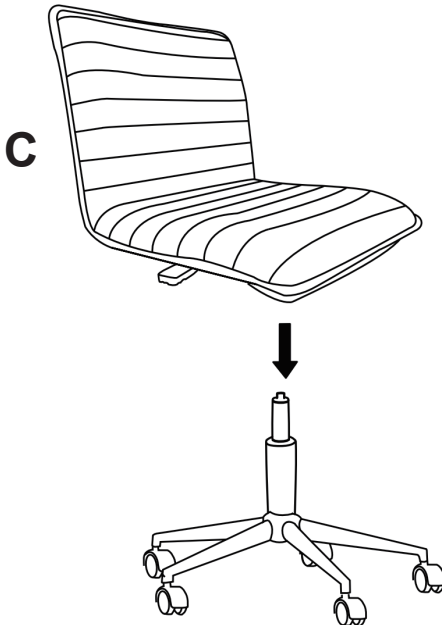

4

