

EXPLODED REVIEW ILLUSTRATION

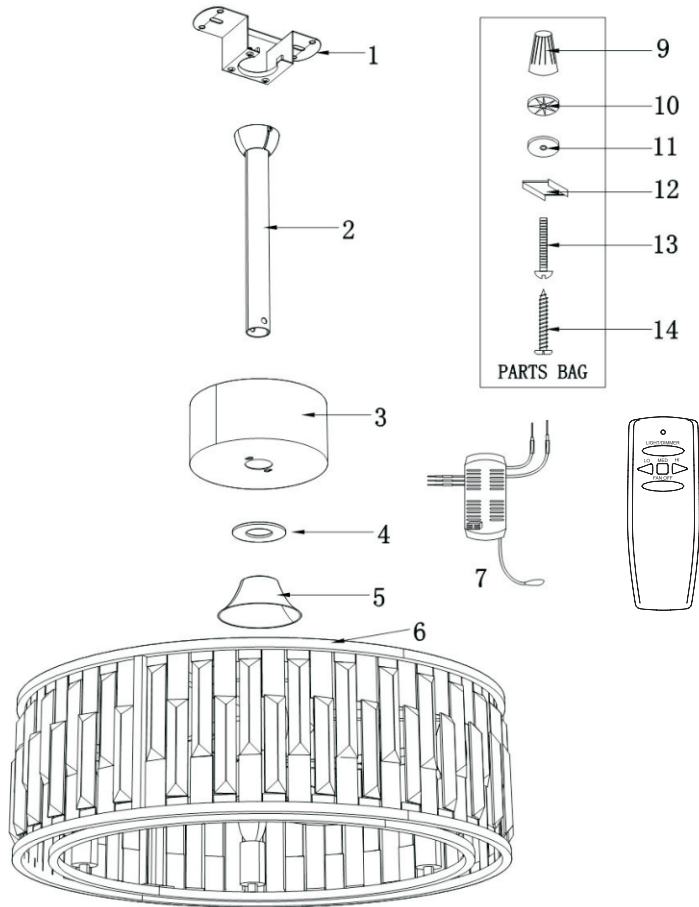

NOTE:

The illustration shown is not scale or its actual configuration may vary. Product/parts are subject to change without notice.

Figure 1

HELIUM 20 INCH CEILING FAN



TABLE OF CONTENTS

Unpacking Instructions ······ 3	How to Operate Your Ceiling Fan ····· 12
Energy Efficient Use of Ceiling Fans ····· 4	Maintenance ······ 14
Electrical and Structural Requirements ···· 4	Troubleshooting ······ 15
How to Assemble Your Ceiling Fan ······ 6	Parts List ······ 16
How to Hang Your Ceiling Fan ······ 8	Exploded-View Illustration ······ 17
How to Wire Your Ceiling Fan ······ 9	Fan blade disassembly diagram ······ 17
How to Install Your Canopy Housing ··· 11	

WARNING

READ AND SAVE THESE INSTRUCTIONS

To avoid fire, shock and serious personal injury, follow these instructions

1. Read your owner's manual and safety information before installing your new fan. Review the accompanying assembly diagrams.
2. Before servicing or cleaning unit, switch power off at service panel and lock service panel disconnecting means to prevent power from being switched on accidentally. When the service disconnecting means cannot be locked, securely fasten a warning device, such as a tag, to the service panel.
3. Be careful of the fan and blades when cleaning, painting, or working near the fan. Always turn off the power to the ceiling fan before servicing.
4. Do not insert anything into the fan blades while the fan is operating.
5. The appliance is not intended for use by young children or infirm persons without supervision. Young children should be supervised to ensure that they do not play with the appliance.

ADDITIONAL SAFETY INSTRUCTIONS

- To avoid possible shock, be sure electricity is turned off at the fuse box before wiring, and do not operate fan without blades.
 - All wiring and installation procedures must satisfy National Electrical Codes (ANSI/NFPA 70) and Local Codes.
The ceiling fan must be grounded as a precaution against possible electrical shock. Electrical installation should be
 - made or approved by a licensed electrician.
 - The fan base must be securely mounted and capable of reliably supporting at least 35 lbs. (fan and accessories not to exceed 35 lbs. or 15.9 kgs.) . See page 5 of owner's manual for support requirements. Consult a
 - qualified electrician if in doubt.
 - The fan must be mounted with the fan blades at least 10 feet from the floor to prevent accidental contact with the
 - ceiling fan.
 - Follow the recommended instructions for the proper method of wiring your ceiling fan. If you do not have adequate electrical knowledge or experience, have your fan installed by licensed electrician.
 - Suitable for use with solid-state speed controls.
 - This fan is to be used in indoor dry or damp location only.
- For supply connections, if the conductor of a fan is identified as a grounded conductor, then it should be connected to a grounded conductor power supply. If the conductor of a fan is identified as an ungrounded conductor, then it should be connected to an ungrounded conductor power supply. If the conductor of a fan is identified for equipment grounding, then it should be connected to an equipment-grounding conductor.

CAUTION: Changes or modifications not expressly approved by the party responsible for compliance could void the user's authority to operate the equipment.

WARNING: To reduce the risk of electric shock, this fan must be installed with a general use, isolating wall.

This product is designed to use only those parts supplied with this product and/or accessories designated specifically for use with this product. Using parts and/or accessories not designated for use with this product could result in personal injury or property damage.

To reduce the risk of personal injury, do not bend the blade bracket (flange or blade holder) when installing the brackets, balancing the blades, or cleaning the fan. Do not insert foreign objects in between rotating fan blades.

To reduce the risk of personal injury, do not bend the blade bracket (flange or blade holder) when installing the brackets, balancing the blades, or cleaning the fan. Do not insert foreign objects in between rotating fan blades.

Mount to an outlet box marked acceptable for fan support of 15.9 kg (35 lbs) or Less.

REPLACEMENT AND DISASSEMBLY DIAGRAM OF FAN BLADES.

Fan blade cleaning and disassembly installation diagram, wipe with dry cloth or chicken blanket. Do not wash with water (figure 1)

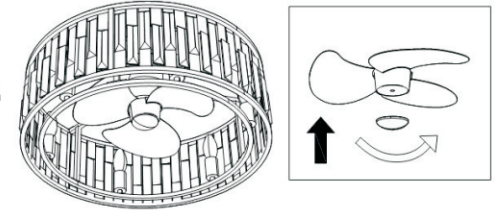

TROUBLESHOOTING



WARNING:

For your own safety turn off power at fuse box or circuit breaker before trouble shooting your fan.

TROUBLE	PROBABLE CAUSE	SUGGESTED REMEDY
1. FAN WILL NOT START	<ol style="list-style-type: none"> 1. Fuse or circuit breaker blown. 2. Loose power line connections to the fan, or loose switch wire connections in the switch housing 3. Dead battery in remote control. 4. Reversing switch in neutral position. 	<ol style="list-style-type: none"> 1. Check main and branch circuit fuses or circuit breakers. 2. Check line wire connections to fan and switch wire connections in the switch housings. CAUTION: Make sure main power is turned off! 3. Replace with new battery. 4. Make sure reversing switch position is all the way to one side.
2. FAN SOUNDS NOISY	<ol style="list-style-type: none"> 1. Loose screws in motor housing. 2. Wire connectors inside housing rattling. 3. Motor noise caused by solid state variable speed control 	<ol style="list-style-type: none"> 1. Check to make sure all screws in motor housing are snug (do not overtighten) . 2. Check to make sure wire connectors in switch housing are not rattling against each other or against the interior wall of the switch housing. CAUTION: Make sure main power is turned off! 3. Some fan motors are sensitive to signals from solid-state variable speed controls. Solid-state controls are not recommended, choose an alternative control method.
3. FAN WOBBLER EXCESSIVELY	<ol style="list-style-type: none"> 1. Setscrew in downrod support is loose. 2. Setscrew in downrod/hanger ball assembly is loose. 3. Hanger bracket and/or ceiling outlet box is not securely fastened. 	<ol style="list-style-type: none"> 1. Tighten both setscrews securely in downrod support. 2. Tighten the setscrew in the downrod/hanger ball assembly. 3. Tighten the hanger bracket screws to the outlet box, and secure outlet box.
4. NOT ENOUGH AIR MOVEMENT		<ol style="list-style-type: none"> 1. If possible, consider using a longer downrod (not included, you can buy the longer downrod from eragroup.com) .

ADDITIONAL SAFETY INSTRUCTIONS



WARNING: Do not operate this fan with a variable (Rheostat) wall controller or dimmer switch. Doing so could result in damage to the ceiling fan's remote control unit. This device complies with Part 15 of the FCC Rules. Operation is subject to the following two conditions:
 so (1) This device may not cause harmful interference, and (2) this device must accept any interference received, including interference that may cause undesired operation. If the intentional radiator can be classified as a Class B digital device or a PC peripheral, then shall include the following or equivalent:



NOTE: This equipment has been tested and found to comply with the limits for Class B digital device, pursuant to part 15 of the FCC Rules. These limits are designed to provide reasonable protection against harmful interference in residential installation. This equipment generates, uses, and can radiate radio frequency energy and, if not installed and used in accordance with the instructions, may cause harmful interference to radio or television reception, which can be determined by turning the equipment off and on. The user is encouraged to try to correct the interference by one or more of the following measures:
 - Reorient or relocate the receiving antenna.
 - Increase the separation between the equipment and the receiver.
 - Connect the equipment into an outlet on a circuit different from that to which the receiver is connected. Consult the dealer or an experienced radio/TV technician for help.

For a Class A digital device, statements of 15.105 (a) must be included when appropriate for the device in question.

WARRANTY

We warrant the fan motor to be free from defects in workmanship and material present at time of shipment from the factory for a period of lifetime after the date of purchase by the original purchaser. We also warrant the light kit, to be free from defects in workmanship and material present at time of shipment from the factory for a period of five years after the date of purchase by the original purchaser, excluding any glass or acrylic components and wooden blades, to be free from defects in workmanship and material at the time of shipment from the factory for a period of two years after the date of purchase by the original purchaser. We agree to correct such defects without charge or at our option replace with a comparable or superior model if the product is returned. To obtain warranty service, you must present a copy of the receipt as proof of purchase. All costs of removing and reinstalling the product are your responsibility. Damage to any part such as by accident, misuse, improper installation or by affixing any accessories, is not covered by this warranty. Because of varying climatic conditions this warranty does not cover any changes in brass finish, including rusting, pitting, corroding, tarnishing or peeling. Brass finishes of this type give their longest useful life when protected from varying weather conditions. A certain amount of "wobble" is normal and should not be considered a defect. Servicing performed by unauthorized persons shall render the warranty invalid. There is no other express warranty. We hereby disclaim any and all warranties, including but not limited to those of merchant ability and fitness for a particular purpose to the extent permitted by law. The duration of any implied warranty which cannot be disclaimed is limited to the time period as specified in the express warranty. Some states do not allow limitation on how long an implied warranty lasts, so the above limitation may not apply to you. The manufacturer shall not be liable for incidental, consequential, or special damages arising out of or in connection with product use or performance except as may otherwise be accorded by law. Some states do not allow the exclusion of incidental or consequential damages, so the above exclusion or limitation may not apply to you. This warranty gives specific legal rights, and you may also have other rights which vary from state to state. This warranty supersedes all prior warranties. Shipping costs for any return of product as part of a claim on the warranty must be paid by the customer.

ENERGY EFFICIENT USE OF CEILING FANS

Ceiling fan performance and energy savings rely heavily on the proper installation and use of the ceiling fan. Here are a few tips to ensure efficient product performance.

Choosing the Appropriate Mounting Location

Ceiling fans should be installed, or mounted, in the middle of the room and at least 10 feet from floor to the blade and 18 inches from wall to the blade. If ceiling height allows, install the fan 8–9 feet from floor to the blade for optimal airflow. Consult your errangroup Retailer for optional mounting accessories.

Turn Off When Not in the Room

Ceiling fans cool people, not rooms. If the room is unoccupied, turn off the ceiling fan to save energy.

Using the Ceiling Fan Year Round

Summer Season: Use the ceiling fan in the clockwise direction. The airflow produced by the ceiling fan creates a wind-chill effect, making you "feel" cooler. Select a fan speed that provides a comfortable breeze, lower speed consume less energy.

Winter Season: Reverse the motor and operate the ceiling fan at low speed in the counter-clockwise direction. This produces a gentle draft, which forces warm air near the ceiling down into the occupied space. Remember to adjust your thermostat when using your ceiling fan—additional energy and dollar savings could be realized with this simple steps!

ELECTRICAL AND STRUCTURAL REQUIREMENTS

Your new ceiling fan will require a grounded electrical supply line of 120 volts AC, 60 HZ, 15 Amp Circuit. Electrical code requires use of a fan-rated outlet box to support the extra weight and motion associated with a ceiling fan. A fan-rated box will be labeled as such and typically supports up to a 70lbs ceiling fan. Fan-Rated Outlet Boxes vary in ratings and design. Ensure the ratings of your ceiling fan outlet box meet the requirements for the ceiling fan being installed. Figure 1, Figure 2 and Figure 3 depicts different structural configurations that may be used for mounting the outlet box.

Low-profile use (Figure 1)

A 12-in. -deep pancake box is meant to be screwed to a joist or block. It's used if only one cable is coming into the box. It is also available in a saddle-mount configuration.

Deep-profile use (Figure 2)

A 2-1-in. -deep box can be attached to blocking between joists and is roomy enough to handle more than one cable.

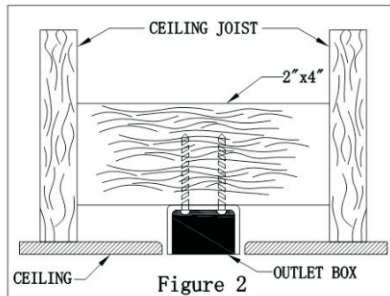
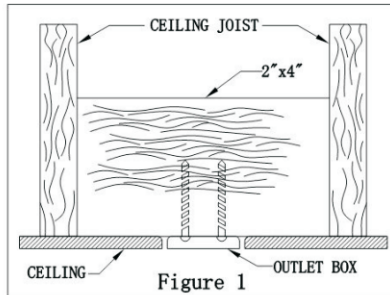

HOW TO OPERATE YOUR CEILING FAN (CONTINUED)

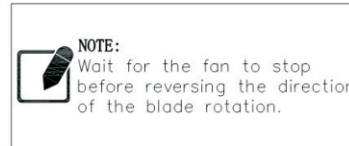

- If airflow is desired in the opposite direction, turn the fan off and wait for the blades to stop turning. Slide the reverse switch on top of motor assembly to the opposite position and turn fan on again. (Figure 6)

Reverse Switch Information		
Season	Rotation Direction	Switch Position
Summer	Clockwise	Left
Winter	Counter-Clockwise	Right

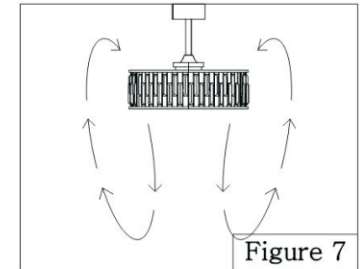

- Warm weather - (Forward) A downward air flow creates a cooling effect as shown in. (Figure 7) This allows you to set your air conditioner on a higher setting without affecting your comfort.

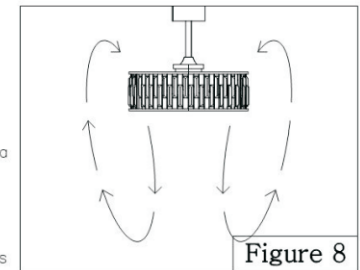

- Cool weather - (Reverse) An upward airflow moves warm air off the ceiling area as shown in. (Figure 8) This allows you to set your heating unit on a lower setting without affecting your comfort.

MAINTENANCE

Periodic cleaning of your new ceiling fan is the only maintenance that is needed. When cleaning, use only soft brush or lint free cloth to avoid scratching the finish. Abrasive cleaning agents are not required and should be avoided to prevent damage to finish.

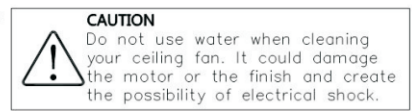

REMOTE INTALLATION

1. SETTING THE CODES

This unit has 16 different code combinations. To set the codes, perform the following steps:

A Setting the codes on the transmitter:

- Remove battery cover. Press firmly on the arrow and slide battery cover off.
- Slide code switches to your choice of up or down position. Factory setting is all up. Do not use this position. Use a small screwdriver or ball point pen to slide firmly up or down (Figure 1).

B Setting the codes on the receiver:

- Slide code switches to the same position as set on your transmitter (Figure 2)
- Replace battery cover on the transmitter.

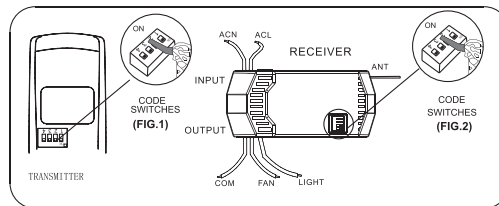

CAUTION: Ceiling Angle Shall Not Exceed 30 Degrees, For Mounting Controller, Model R28

2. INSTALLING RECEIVER IN CEILING FAN

A Safety precautions:

WARNING: HIGH VOLTAGE! Disconnect power by removing fuse or switching off circuit breaker. Do not use with solid state fans. Electrical wire must meet all local and national electrical code requirements. Supply for fan must be 110/120 volt, 60Hz. Maximum fan motor amps: 1.0, Maximum light watts: 240 incandescent or LED. Otherwise power can cause serious injury or death.

B Installing receiver in fan:

- Remove power from the circuit.
- Remove ceiling fan canopy from the mounting bracket.
- Disconnect existing wiring between ceiling fan and Supply in electrical junction box.
- Make connections as follows, using the wire nuts supplied:

CONNECT TO

Green fan wireBare supply wire
 Red receiver wire(AC IN L)Red or Black supply wire
 White receiver wire(AC IN N)White supply wire
 White receiver wire(TO MOTOR N)White fan wire
 Black receiver wire(TO MOTOR L)Black fan wire
 Blue receiver wire(FOR LIGHT)Blue light wire

FROM POWER SOURCE
 AC 110~120 VOLT 60HZ
 3.5AMPS.

Use wire connecting nuts supplied with the fan

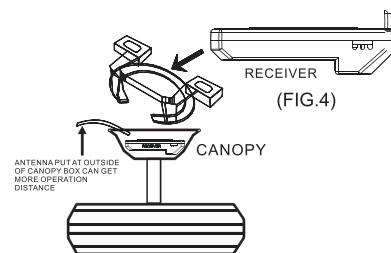
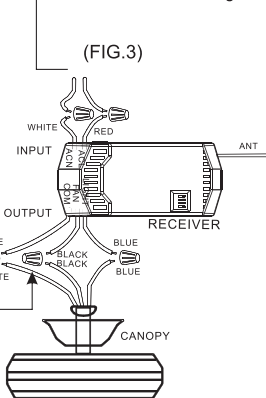

If other fans or supply wires are different color, have this unit installed by qualified licensed electrician.

- Push all connected wires up into junction box.
- Lay the brown antenna wire on top of the receiver, and put the receiver into the mounting bracket.
- Reinstall the canopy on the mounting bracket.
- Restore power.

ELECTRICAL AND STRUCTURAL ERQUIREMENTS (CONTINUED)

Brace use (Figure 3)

Paired with a deep box, this hanger is meant to span between two joists and takes the place of wooden blocking.

WARNING: To reduce the risk of fire, electrical shock, or personal injury, mount fan to outlet box marked acceptable for fan support of 15.9 kg (35 lbs) or less. Use screws supplied with outlet box. Most outlet boxes commonly used for support of light fixtures are not acceptable for fan support and may need to be replaced. Consult a qualified electrician if in doubt.

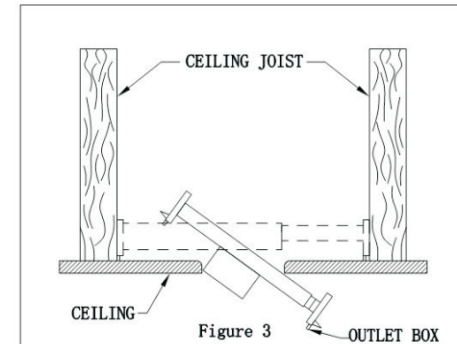

If your fan is to replace an existing light fixture, turn electricity off at the main fuse box at this time and remove the existing light fixture.

WARNING: Turning off wall switch is not sufficient. To avoid possible electrical shock, be sure electricity is turned off at the main fuse box before wiring. All wiring must be in accordance with National and Local code and the ceiling fan must be properly grounded as a precaution against possible electrical shock.

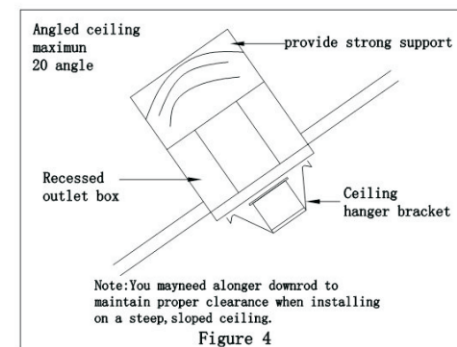

WARNING: To avoid fire or shock, follow all wiring instructions carefully. Any electrical work not described in these instructions should be done or approved by a licensed electrician.

NOTE: You may need a longer downrod (sold separately) to maintain proper clearance when installing on steep, sloped ceiling.

WARNING: Do not operate this fan with a variable (Rheostat) wall controller or dimmer switch. Doing so could result in damage to the ceiling fan's remote control unit.

Angled ceiling use place (Figure 4)
 Angled ceiling maximum 20 angle

PRE-INSTALLATION

This manual is designed to make it as easy as possible for you to assemble, install, operate and maintain your ceiling fan.

Tools Needed for Assembly (Not Included)



Phillips
screwdriver

One 1/4" blade
screwdriver

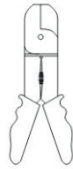

Wire strippers/
cutters



One
stepladder

MATERIALS NEEDED

Wiring outlet and connectors of type required by the local code. The minimum wire would be a 3-con(2-wire with ground) of the following size:

Installed wire length	Wire Size A. W. G
Up to 50 ft.	12
50-100 ft.	12



NOTE: Place the parts from the loose parts bags in a small container to keep them from being lost. If any parts are missing contact your local retailer.



WARNING: Before assembling your ceiling fan, refer to section on proper method of wiring your fan (page 10). If you feel you do not have enough wiring knowledge or experience, have your fan installed by a licensed electrician.

REMOTE OPERATION

1. OPERATING TRANSMITTER:

- Install 9 volt battery (not included). (To prevent damage to transmitter, remove the battery if not used for a long time).
- Store the transmitter away from excessive heat or humidity.
- This remote control unit is equipped with 16 code combinations. In order to prevent possible interference from or to other remote units such as garage door openers, car alarm or security system. If you find that your fan and light kit go on and off without using your remote control, simply change the code combination in your transmitter and receiver.
- Operating the buttons on the panel of the transmitter.
 - HI key - for fan high speed.
 - MED key - for fan medium speed.
 - LOW key - for fan low speed.
 - OFF key - for fan off.

LIGHT/DIMMER key-for light brightness and off.

- ★ The light function is controlled by pressing the LIGHT/DIMMER key down to increase or decrease light. Tap key quickly to turn light off or on.
- ★ Keep pressing the button in excess of 0.7 second and it becomes a dimmer, the light varies cyclically in 0.8 second. The receiver can remember the last status of the light brightness when the light was switched, so that it can resume to adjust the light brightness.

YOUR REMOTE NOW HAS FULL CONTROL OF THE FAN AND LIGHT.

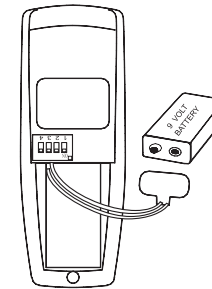

^oOptional Wall Mounting for Transmitter Holder^o
Place in accessible area of your home, and screw the transmitter holder into wall using the two screws provided, slide hand unit into holder.

OPERATION DISTANCE 20 FEET

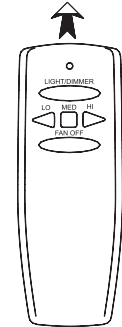

MODEL:
HK-01

TRANSMITTER

2. TROUBLE SHOOTING GUIDE

- Make sure power is correctly connected to the receiver.
- Make sure the fan pull chain (if included) at highest position.
- Make sure the light kit switch turned on.
- Make sure good battery in transmitter.
- Make sure the code set at exact same positions in both transmitter and receiver.
- Make sure the transmitter operates within 20 feet away from the ceiling fan.

NOTICE !

Your ceiling fan and light kit assembly must meet the following requirements:

- Do not use with solid state fans.
- Electrical rating: 120v 60Hz 3.5A
MAX. Motor amps: 1.0
MAX. Light watts: 240-(incandescent or LED)

WARNING

TO REDUCE THE RISK OF SHOCK, THIS FAN MUST BE INSTALLED WITH A WALL CONTROL/SWITCH.
NOTE: THE MANUFACTURER IS NOT RESPONSIBLE FOR ANY RADIO OR TV INTERFERENCE CAUSED BY UNAUTHORIZED MODIFICATIONS TO THIS EQUIPMENT. SUCH MODIFICATIONS COULD VOID THE USER'S AUTHORITY TO OPERATE THE EQUIPMENT.

HOW TO INSTALL YOUR CANOPY HOUSING



NOTE:

This step is applicable after the necessary wiring is completed.

Assemble canopy by rotating key slot in canopy over shoulder screw in hanger bracket, taking care not to pinch the wires. Tighten shoulder screw. Fully assemble and tighten second shoulder screw that was previously removed. (Figure 1)

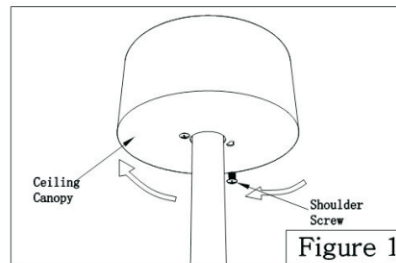

Figure 1



WARNING:

To avoid possible fire or shock, make sure that the electrical wires are completely inside the canopy housing and not pinched between the housing and the ceiling.

Securely attach and tighten the three "L" tabs of canopy screw cover over the three slots of canopy utilizing the key slot twist-lock feature. (Figure 2)

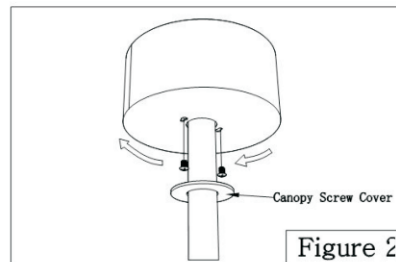

Figure 2

UNPACKING INSTRUCTIONS

PACKAGE CONTENTS

For your convenience, check-off boxes are provided next to each step. As each step is completed, place a check mark in the box. This will insure that all steps have been completed and will be helpful in finding your place should you be interrupted.



WARNING:

Do not install or use fan if any part is damaged or missing. This product is designed to use only those parts supplied with this product and/or any accessories designated specifically for use with this product by our group. Substitution of parts or accessories not designated for use with this product by our group could result in personal injury or property damage.

1. Check to see that you have received the following parts:



NOTE: If you are uncertain of part description, refer to exploded view illustration provided on the last page of this install manual.

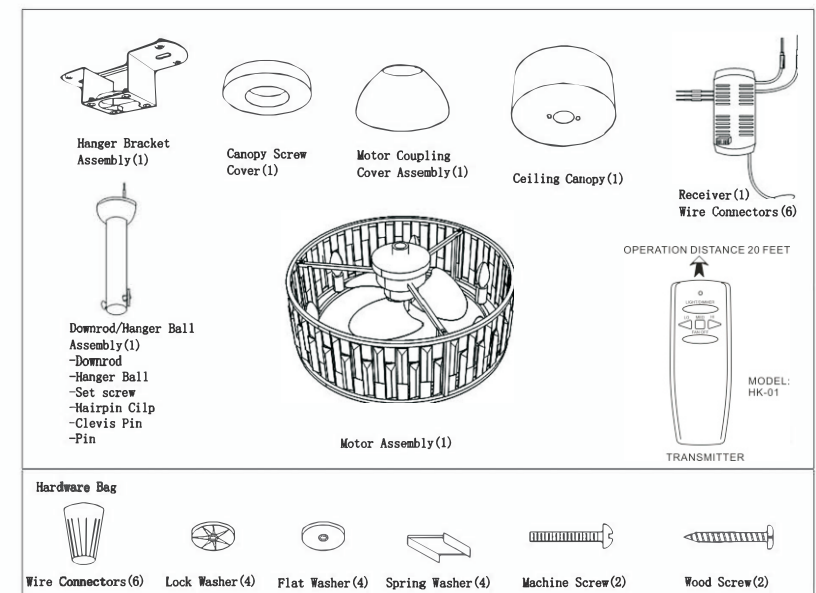

HOW TO ASSEMBLE YOUR CEILING FAN

- Remove the hanger ball portion from the downrod/hanger ball assembly by loosening the set screw in the hanger ball until the ball falls freely down the downrod. Remove the pin from the downrod, then remove the hanger ball. Retain the pin and hanger ball for reinstallation in Step 6. (Figure 1)

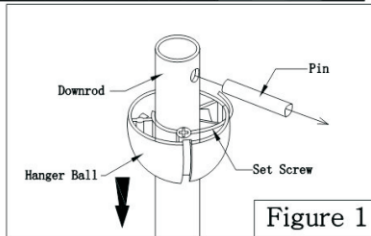

Figure 1

- Remove the hairpin clip and clevis pin from the bottom of the downrod. Retain the pin and clip for reinstallation in Step 4. (Figure 2)

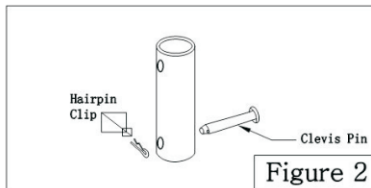

Figure 2

- Loosen the two set screws in the downrod support of the motor assembly. Route the black, white and blue wires through the downrod. (Figure 3)

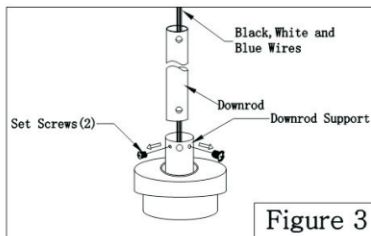

Figure 3

- Thread downrod into the downrod support on top of the motor. Install the clevis pin by aligning the hole in the downrod support with holes in the downrod. Secure clevis pin with hairpin clip. Tighten the two setscrews with in the downrod support. (Figure 4)



WARNING:
It is critical that the clevis pin in the downrod support is properly installed and the setscrews are securely tightened. Failure to do so could result in the fan falling.

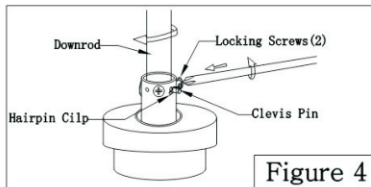

Figure 4

- Route wires through motor coupling cover, canopy screw cover and ceiling canopy. (Figure 5)

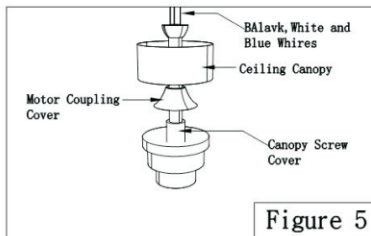

Figure 5

WIRING YOUR CEILING FAN (CONTINUED)



WARNING:
Check to see that all connections are tight, including ground, and that no bare wire is visible at the wire connectors except for the ground wire. Do not operate fan until the blades are in place. Noise and motor damage could result.

After the wires are connected, bundle the wires with cable ties, and then place the junction box in the hanger

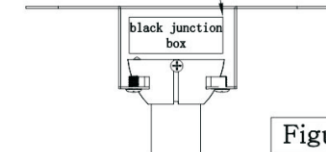

Figure 4

- After connections have been made, turn leads upward and carefully push leads into the outlet box, with the white and green leads to one side of the box and the black leads to the other side. (Figure 4)

- Use bandage to extend into the wave filter mounting hole and the screw hole of the hanger bracket, and tighten bandage (for subsequent installation of the ceiling Canopy). (Figure 5)

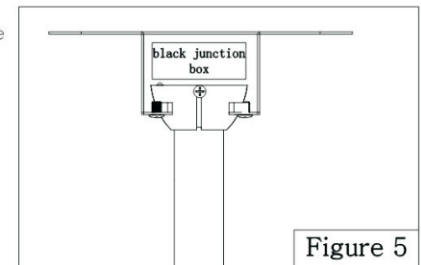
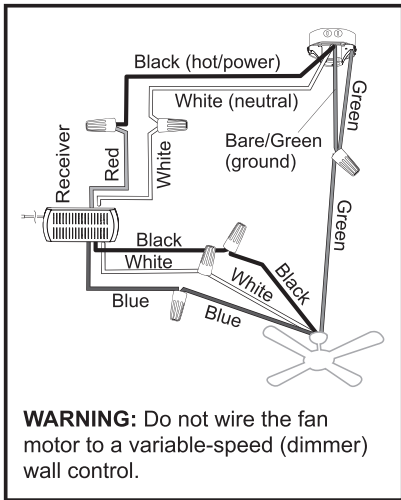

Figure 5

WIRE CONNECTION



1. Use wire connectors to connect household supply and receiver wires according to the diagram and the following steps:

- Connect the green wire from the downrod and mounting bracket to the Bare/Green (ground) supply wire.
- Connect the Blue wire with the white label to the blue fan wire.
- Connect the Black wire with the white label to the black fan wire.
- Connect the White wire with the white label to the white fan wire.
- Connect the Red wire with the red label to the Black (live) supply wire.
- Connect the White wire with the red label to the White (neutral) supply wire.

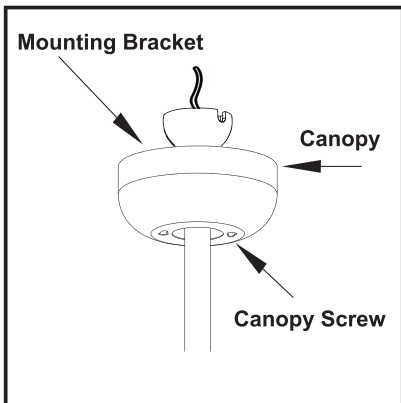

2. Lift the ceiling canopy up into place covering the mounting bracket. Push the canopy up so the screws come through the mounting holes in the canopy. Rotate the canopy slightly and tighten the screws.

Please refer to page 9~10 for remote controller and receiver installation and operation detail.

HOW TO ASSEMBLE YOUR CEILING FAN (CONTINUED)

□ Reinstall the hanger ball on the downrod as follows. Route the black, white and blue wires through the hanger ball. Position the pin through the two holes in the downrod and align the hanger ball so the pin is captured in the groove in the top of the hanger ball. Pull the hanger ball up tight against the pin. Securely tighten the set screw in the hanger ball. A loose setscrew could create fan wobble. (Figure 6)

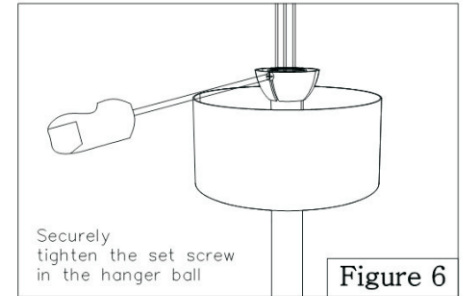

□ Cut off excess lead wire approximately 6 to 9 inches above top of the downrod. Strip insulation off 1/2 inch from the end of each lead wire. (Figure 7)

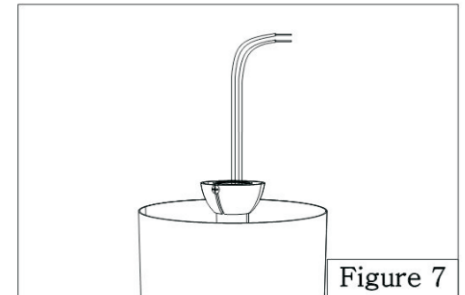
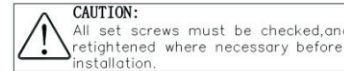

□ Remove one of the two shoulder screws in the hanger bracket and retain the screw for later. Loosen the second shoulder screw without fully removing it. (Figure 8)

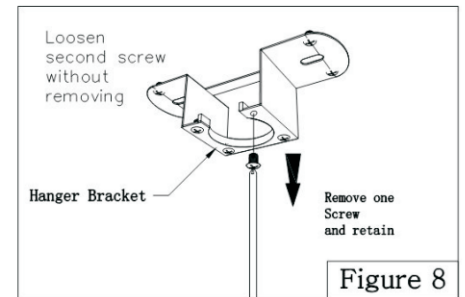

HOW TO HANG YOUR CEILIN

WARNING:
To avoid possible re or shock,be sure electricity is turned off at the main fuse box before hanging. (Figure 1)

NOTE:
If you are not sure if the outlet box is grounded,contact a licensed electrician for advice,as it must be grounded for safe operation.

WARNING:The fan must be hung with at least 10'ofclearance from floor to ceiling fan. (Figure 2)

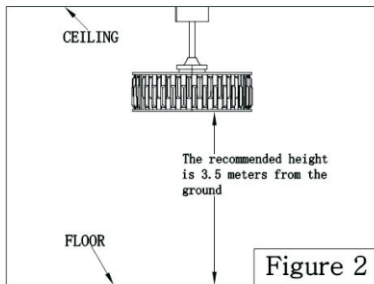

Securely attach the hanger bracket to the outlet box using the outlet box screws and washers supplied with the outlet box. (Figure 3)

WARNING:
The outlet box must be securely anchored.Hanger bracket must seat rmly against outlet box. If the outlet box is recessed,remove wall board until bracket contacts box. If bracket and/or outlet box are not securely attached,the fan could wobble or fall.

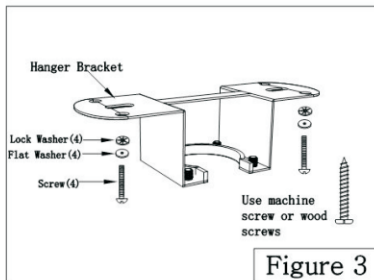

Carefully lift the fan and seat the downrod/hanger ball assembly onto the hanger bracket that was just attached to the outlet box. Be sure the groove in the ball is lined up with tab on the hanger bracket. (Figure 4)This fan is intended for standard and angled mounting options only. Close mount and flush mount options are not available. For angled ceilings,note the angle can be no more than 20°

WARNING:
Failure to seat tab in groove could cause damage to electrical wires and possible shock or re hazard.

WARNING:
To avoid possible shock,do not pinch wires between the hanger ball assembly and the hanger bracket.

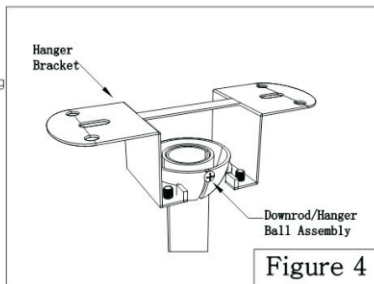

PAIR REMOTE & RECEIVER

NOTE:
The remote unit has 16 different code combinations. To prevent possible interference from or to other remote units,simply change the combination code in the remote and receiver.

To set the code on receiver unit, slide dip switches to the same positions as set on the remote. (Figure 1)

NOTE:
Factory default setting is dip switches all up.Do not use this position.

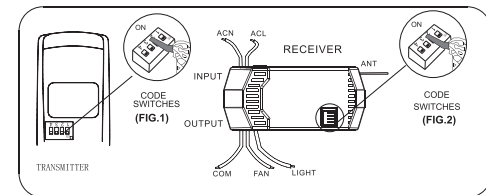

WIRE THE CEILING FAN

WARNING:
To avoid possible electrical shock,be sure electricity is turned off at the main fuse box before wiring. (Figure 2)

NOTE:
If you are not sure if the outlet box is grounded,contact a licensed electrician for advice,asit must be grounded for safe operation.

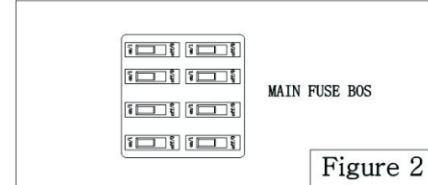

Turn electricity off at the main fuse box before wiring the fan.