

ASSEMBLY INSTRUCTIONS

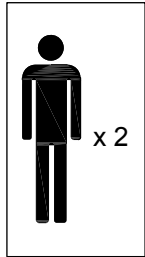
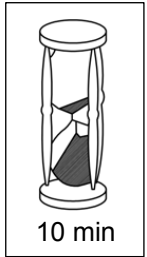

USEFUL HINTS BEFORE YOU START:

1. Read each step carefully before starting.
2. It is important that each step is performed in correct order to avoid difficulties.
3. Identify, sort and count the parts before assembly.
4. Assemble the product on packaging cardboard to prevent scratch or damage.
5. Using incompatible hardware might cause damage to the product.

IMPORTANT NOTES:





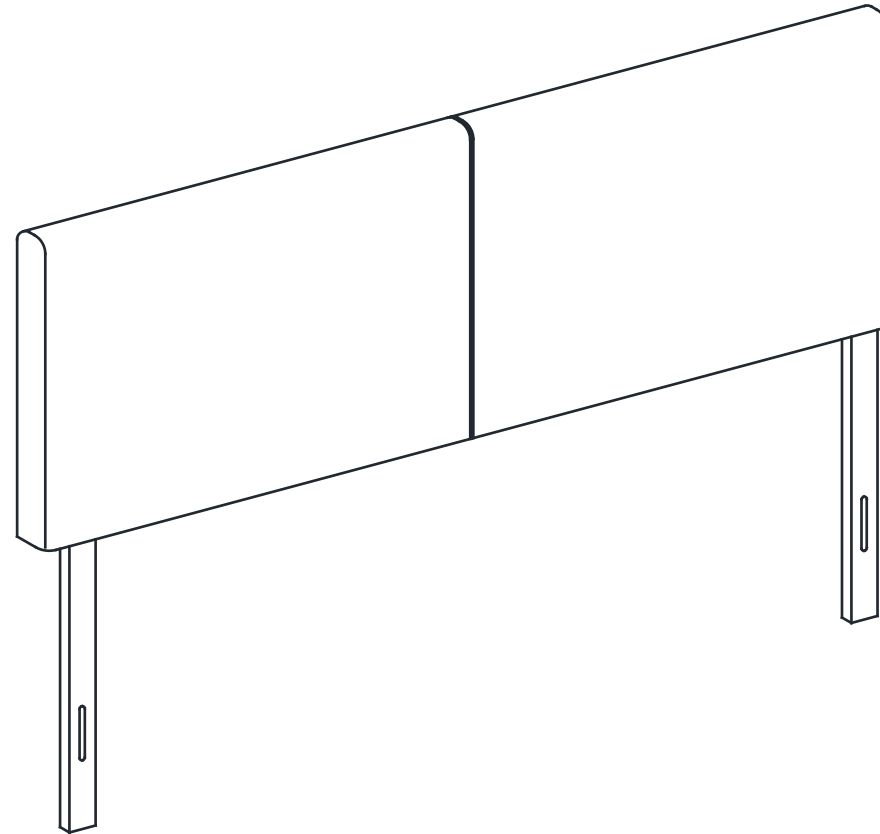





1. DO NOT FULLY-TIGHTEN the nut until all nuts are ready assembled.
2. DO NOT OVER-TIGHTEN the nut to avoid causing damages to the thread.
3. Keep all hardware parts out of reach of children.

NEED HELP? For replacement requests or product inquiries, please contact our Customer Service Team by emailing us at support@furinno.com. Thank you for selecting Furinno!



HOLSTERED HEADBOARD

ASSEMBLY INSTRUCTION

NO	PART LIST	QTY
1	 HEADBOARD CUSHION	1PC
2	 HEADBOARD LEG	2PCS
NO	HARDWARE LIST	QTY
A	 JCBC SCREW M 8 X 35	4PCS
B	 SPRING WASHER M8 X 14	4PCS
C	 FLAT WASHER M8 X 22	4PCS
D	 JCBC SCREW M6 X 50	4PCS
E	 SPRING WASHER M6 X 12	4PCS
F	 FLAT WASHER M6 X 19	8PCS
G	 HEX NUT M6	4PCS
H	 ALLEN KEY M4	1PC
I	 ALLEN KEY M5	1PC

STEP 1

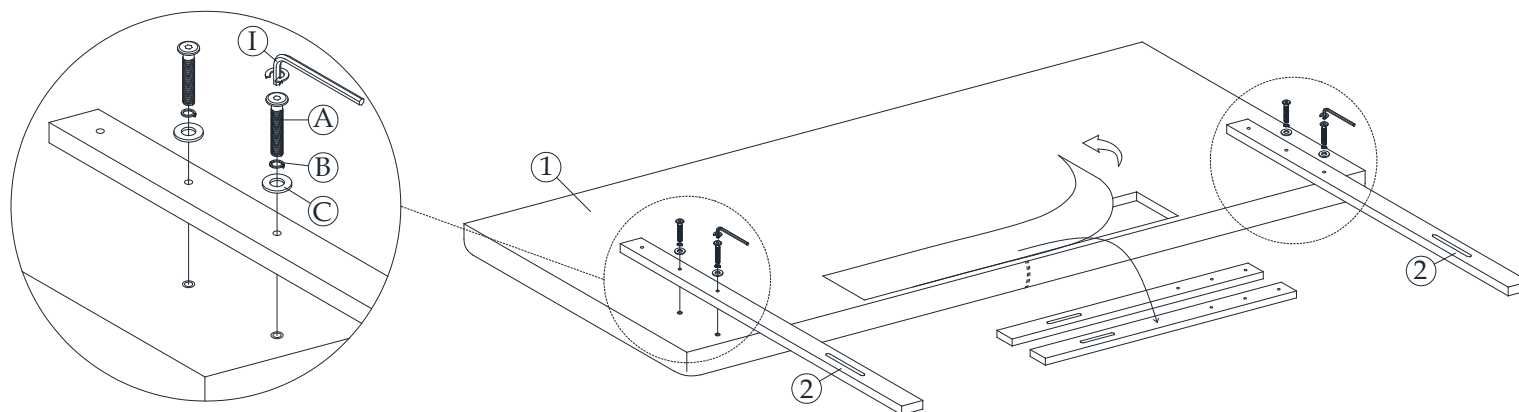

STEP 2

