





INSTALLATION INSTRUCTIONS

J	 Tea Table Top	1
K	 Tea Side Board	2
L	 Tea Side Board	2
M	 Glass	1
X	 M6*35	12
Y		12

Step 1

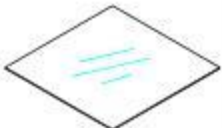

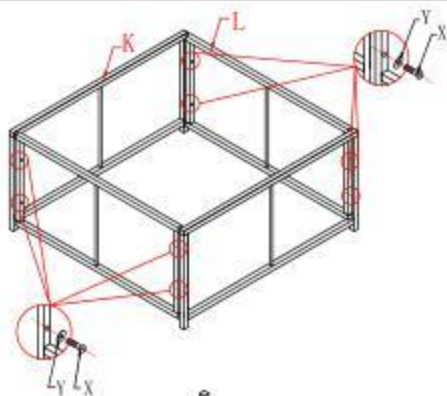
Step 2

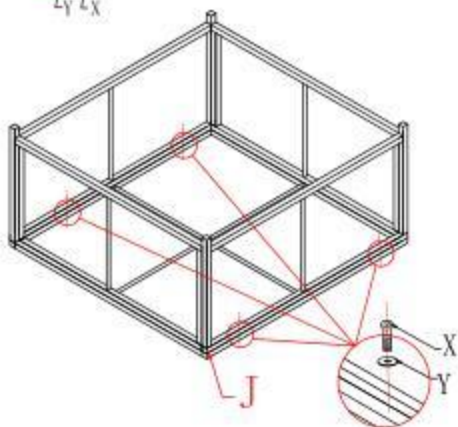



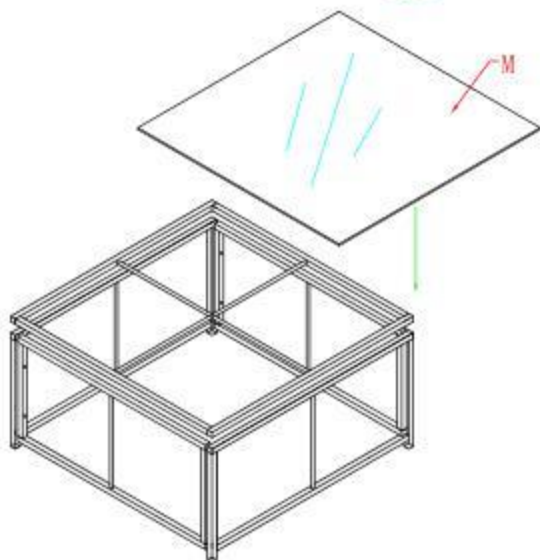

Step 3

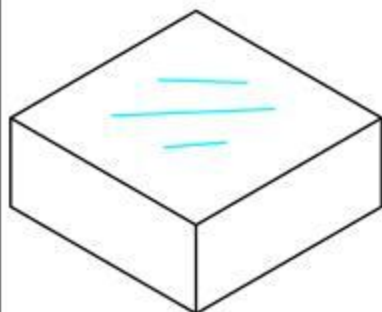

Coffee Table



INSTALLATION INSTRUCTIONS

G	 OT Top	1
H	 OT Side Board	2
I	 OT Side Board	2
X	 M6*35	12
Y		12

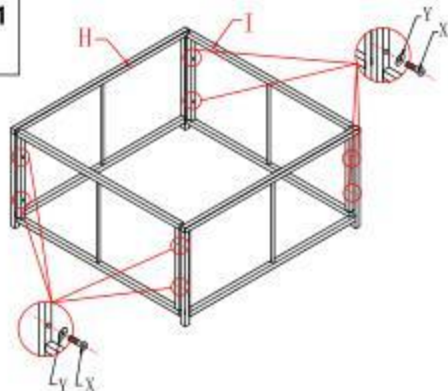
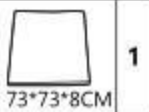

Step 2

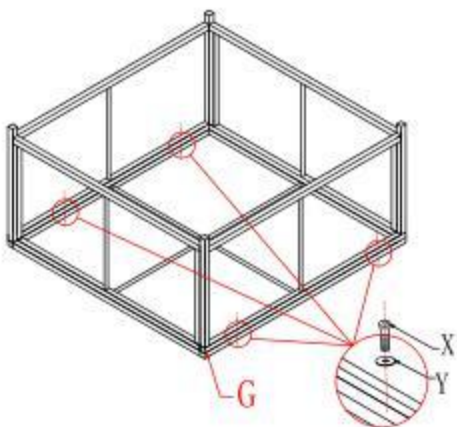

Notice:
 1. Please take out the sponge from the cushions before the washing
 2. Please don't use the washing machine or brush, it will tear the fabric. Please do manual cleaning





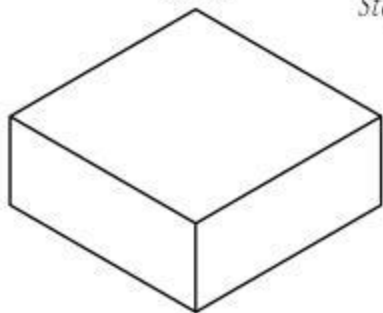



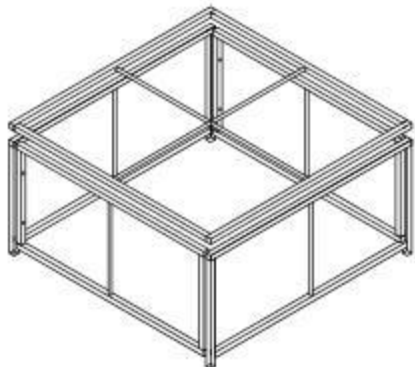

Ottoman



Step 3



INSTALLATION INSTRUCTIONS

E	 Armless Back	1	 63*63*8CM	1
F	 Armless Seat	1	 32*63*10CM	1
D	 Side Board	2		
X	 MG*35	12		
Y		12		
Z		1		

Armless sofa

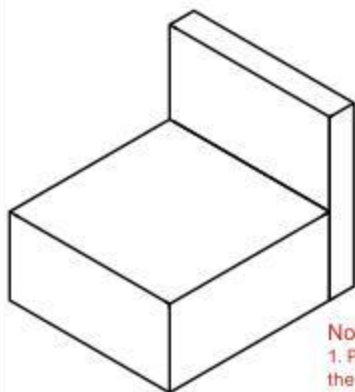





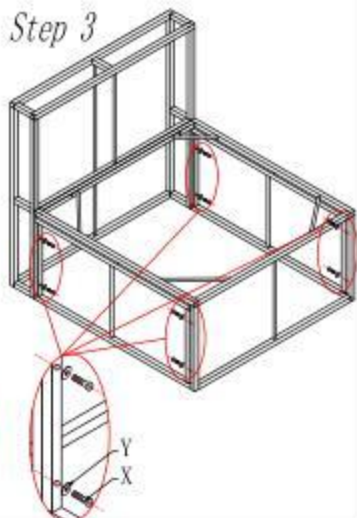
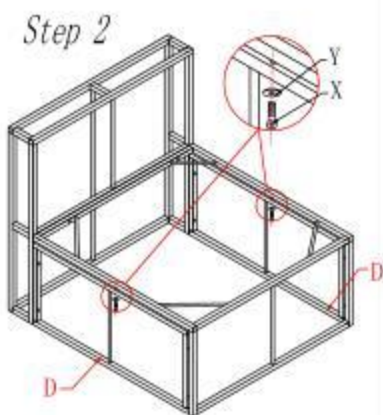
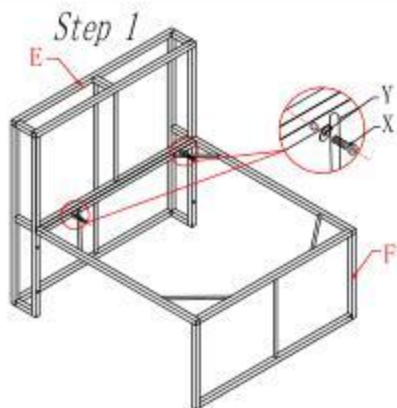

Notice:

1. Please take out the sponge from the cushions before the washing
2. Please don't use the washing machine or brush, it will tear the fabric. Please do manual cleaning



INSTALLATION INSTRUCTIONS

A	 Corner Back	1
B	 Corner Armrest	1
C	 Corner Seat	1
D	 Side Board	1
X	 M6*35	13
Y		13
Z		1

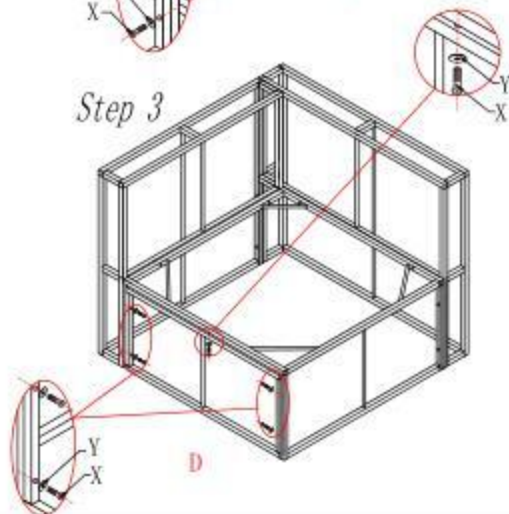
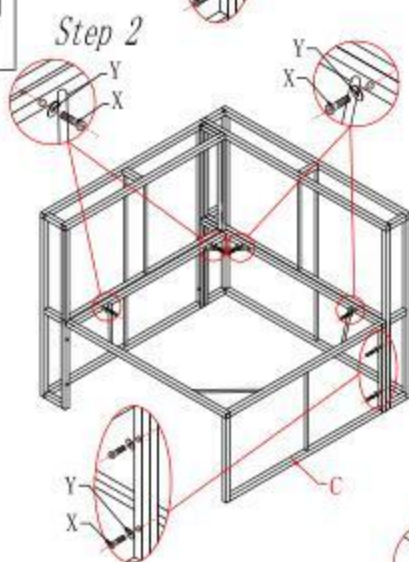
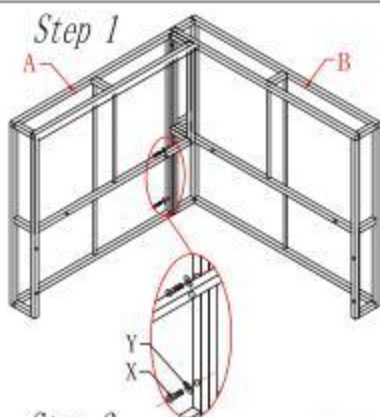
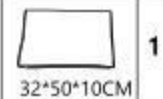
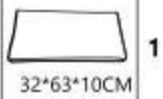

Corner Sofa

