

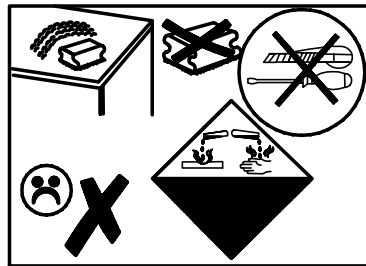

 40min

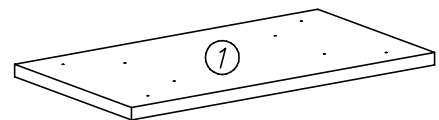
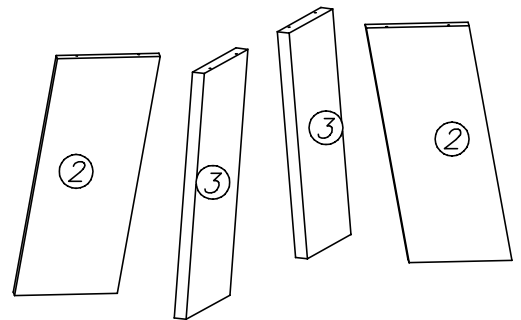
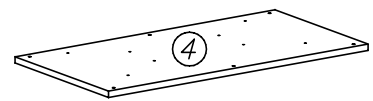
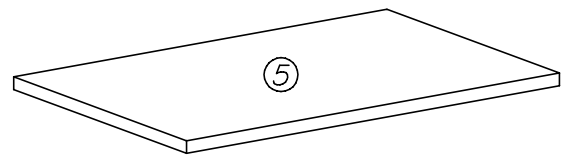
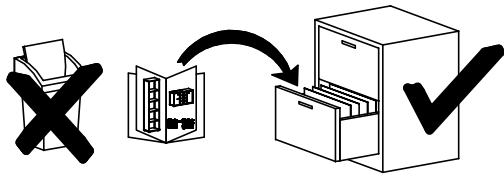
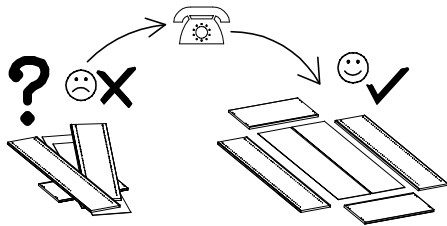
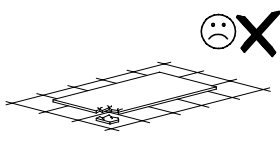
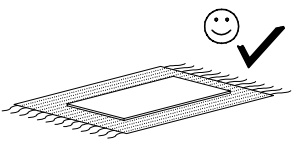
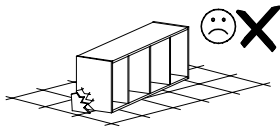
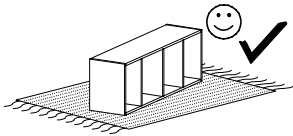
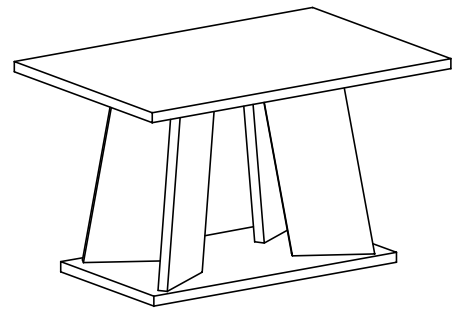
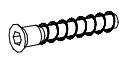

A5 
7 x 60 x4

A1 
7 x 50 x12

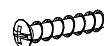
G27 
6,3 x 30 x6

P4 
x6

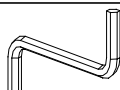
W2 
x1

I

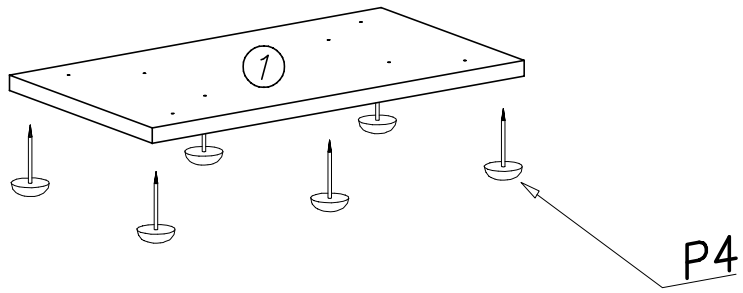

II

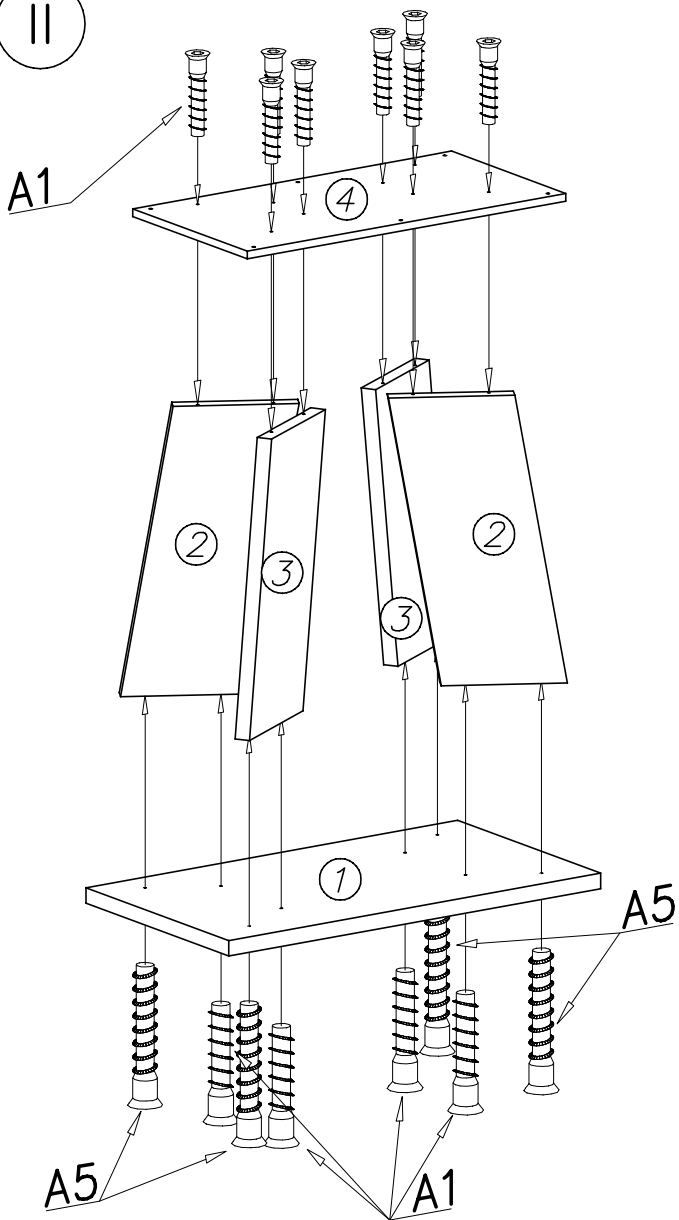

III

