





ASSEMBLY INSTRUCTION

DESCRIPTION : DROF LEAF TABLE

Thank you for purchasing this product. Be sure to check all packing material carefully for small parts which may have come loose inside the carton during shipment. Identify and count all parts and compare with the parts list below:

Component List		
NO.	Description	Qty.
1	Table Top 	1
2	Table Leg 	4

Assembly Hardware Pack		
NO.	Description	Qty.
A	JCBB M8 x 80mm + S/W 5/16" + F/W 5/16" x 22mm 	8
B	Allen Key M5 	1

STEP 1 :

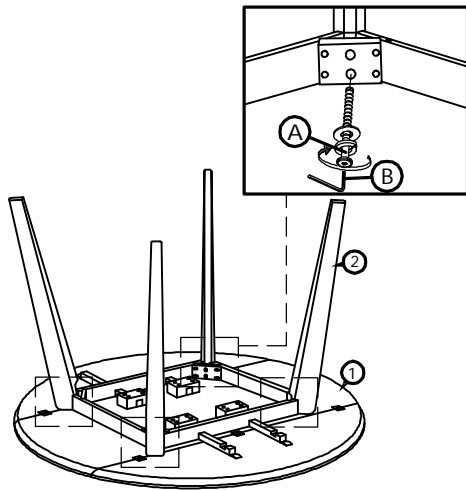

STEP 2 :

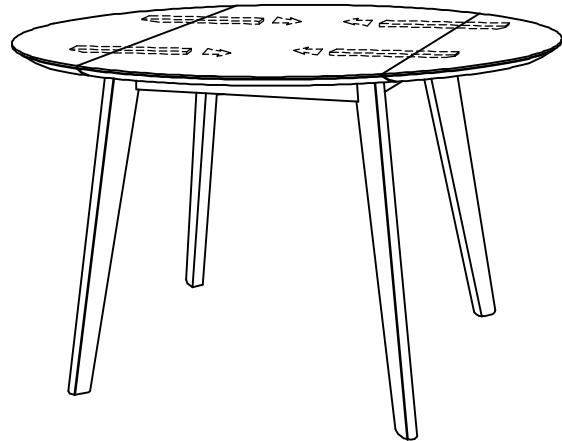

STEP 3 :

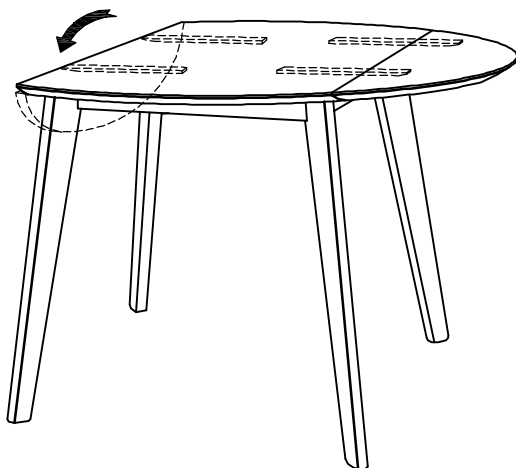

STEP 4 :



DROF LEAF TABLE

ASSEMBLY TIPS:

1. Remove hardware from box end sort by size.
2. Please check to see that all hardware and parts are present prior start of assembly.
3. Please follow attached instructions in the same sequence as numbered to assure fast and easy assembly.

⚠ WARNING!

1. Don't attempt to repair or modify parts that are broken or defective. Please contact the store immediately.
2. This product is for home use only and not intended for commercial establishments.