

MANUAL INSTRUCTION

Gazebo with Sidewall Curtains G30005

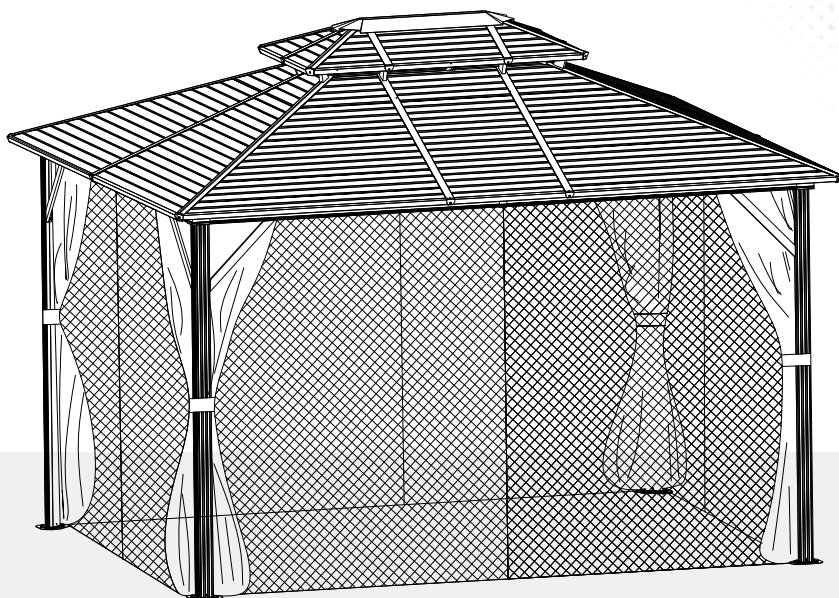

Outdoor Furniture

We are a professional furniture provider with top-notch factories and outstanding designs, Our mission is to provide consumers with new lifestyles. By collecting consumer feedback, we constantly improve our products and create more choices for consumers. If you want to create your space, We are an ideal choice.

Always.

WARNING

- In case of windy weather, please do not stand in the gazebo.
- Please do not stand under the gazebo in case of heavy snowfall.
- For safety, please use expansion screws to reinforce the posts to the ground.
- In windy weather, please tighten the fence and netting to avoid tearing in high winds.
- In extreme weather conditions, you can use a rope to pull the four corners of the gazebo to keep it stable.
- Please clear the snow off the roof in time for the heavy snowfall.
- Make sure all screws are tightened before use.
- Repeat to confirm all screws, buckles and straps every 90 days.
- Please keep all screws loose during the assembly process and tighten them after completing the installation.
- Do not use or store next to a pole with an open flame or flammable chemicals.
- Please note that some parts have sharp edges and should be handled with gloves.
- If any parts are missing, broken, damaged or worn, discontinue use of the product until repairs are made or factory replacement parts are installed.
- Installation of the product in a manner that does not conform to the manufacturer's instructions may result in the loss of the warranty policy for this product.

CALIFORNIA PROPOSITION 65

WARNING: This product can expose you to Carbon monoxide, which is known to the State of California to cause birth defects or other reproductive harm. For more information go to www.P65Warnings.ca.gov

ATTENTION:

1. Please read this instruction carefully before installation and follow it strictly during installation.
2. Ensure that there are no problems later due to installation errors.
3. We have prepared extra screws for you to use in case of loss or damage.

Installation Notes

1. Please check the quantity of all parts before installation (Please refer to the Parts Lists) and the appearance of the products. Please make sure the product is correct before installation.
2. If there is any problem, please contact us directly.
3. Make sure the colored panels are facing outwards and all the holes match.
4. The panels are textured, please install the panels in the order specified in the instructions.
5. All lines and holes must be accurately matched to make the storage shed more stable.
6. Please ensure that all screws are tightened to prevent the product from falling apart.
7. There is a protective film on the surface to protect the product, please tear it off after installation to get the final presentation. If you do not damage the film during installation, it can also remain on the product to protect the product.
8. Please place the product on a flat ground to prevent leaning and collapse.
9. If the ground is uneven, the door may can't be closed.

Safety Precautions

1. We recommend two adults to complete the installation.
2. Two adults installed together will make the installation process easier and safer.
3. The gloves must be carried to prevent hand cuts during installation.
4. Take care when using power tools near water the use of a residual current device (RCD) is advised. Please use the electric driver carefully during screwing to prevent the screw from slipping and hurting your hand. (We recommend that beginners use a manual screwdriver for installation.) Be careful not to fall when installing the roof.
5. Please steady the ladder and make sure the product placed on a flat ground.

PLEASE KEEP THIS INSTRUCTION FOR FUTURE REFERENCE.

TOOLS REQUIRED

EQUIPMENT REQUIRED (Not included in boxes)

*NOTE: Tools / equipment are not shown to actual size and scale.



LEVEL



RUBBER MALLET



PHILLIPS SCREW



DRILL



ALLEN KEY

EQUIPMENT REQUIRED (Not included in boxes)

*NOTE: Equipment are not shown to actual size and scale.



SAFETY HAT



GLOVES



SAFETY GOGGLES



**STEPLADDER
(6.5Ft Or More)**

Matters needing attention



**Three or more people
are required for
assembloe**



**Do not fully tighten
screws prior to complete
assembly**

PARTS

A

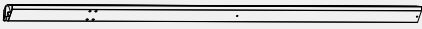

4 PCS

B1



2 PCS

B2



2 PCS

B3



2 PCS

B4



2 PCS

C1



4 PCS

C2



4 PCS

C3



4 PCS

C4



2 PCS

D1



4 PCS

D2



4 PCS

D3



4 PCS

E



8 PCS

E1



2 PCS

F1



4 PCS

PARTS

F2



4 PCS

F3

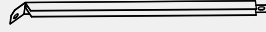

4 PCS

F4



4 PCS

F5



4 PCS

F6



4 PCS

F7



4 PCS

F8

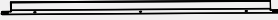

2 PCS

G1



4 PCS

G2



4 PCS

H



4 PCS

I



4 PCS

J1



1 PC

J2

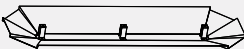

1 PC

K1



12 PCS

PARTS

K2



18 PCS

L



4 PCS

M1

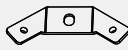

4 PCS

M2

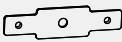

6 PCS

Q



2 PCS

Q1

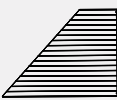

4 PCS

Q2

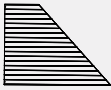

4 PCS

R

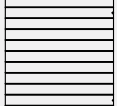

2 PCS

R1



4 PCS

R2



4 PCS

S



2 PCS

S1



4 PCS

S2



4 PCS

T1



4 PCS

PARTS

T2

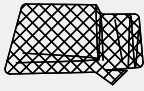

4 PCS

T3

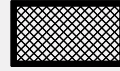

1PC

U



104+4 PCS

V



20 PCS

W

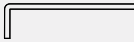

12 PCS

HARDWARE

1 M6x16mm



123+4 PCS

2 M6x10mm



92+2 PCS

3 M5x12mm



4 PCS

4 ST4.8x12mm



24+2 PCS

5

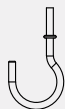

2 PCS

6 M6x50mm

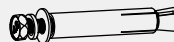

12 PCS

7 M6x20mm

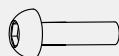

8 PCS





2 PCS



1 PC

PRODUCT ASSEMBLY

1 Attach the bottom of part "A" to part "H" and tighten with 3 screws "1".

PART	NO.	QTY.
	A	4
	H	4
	1	12



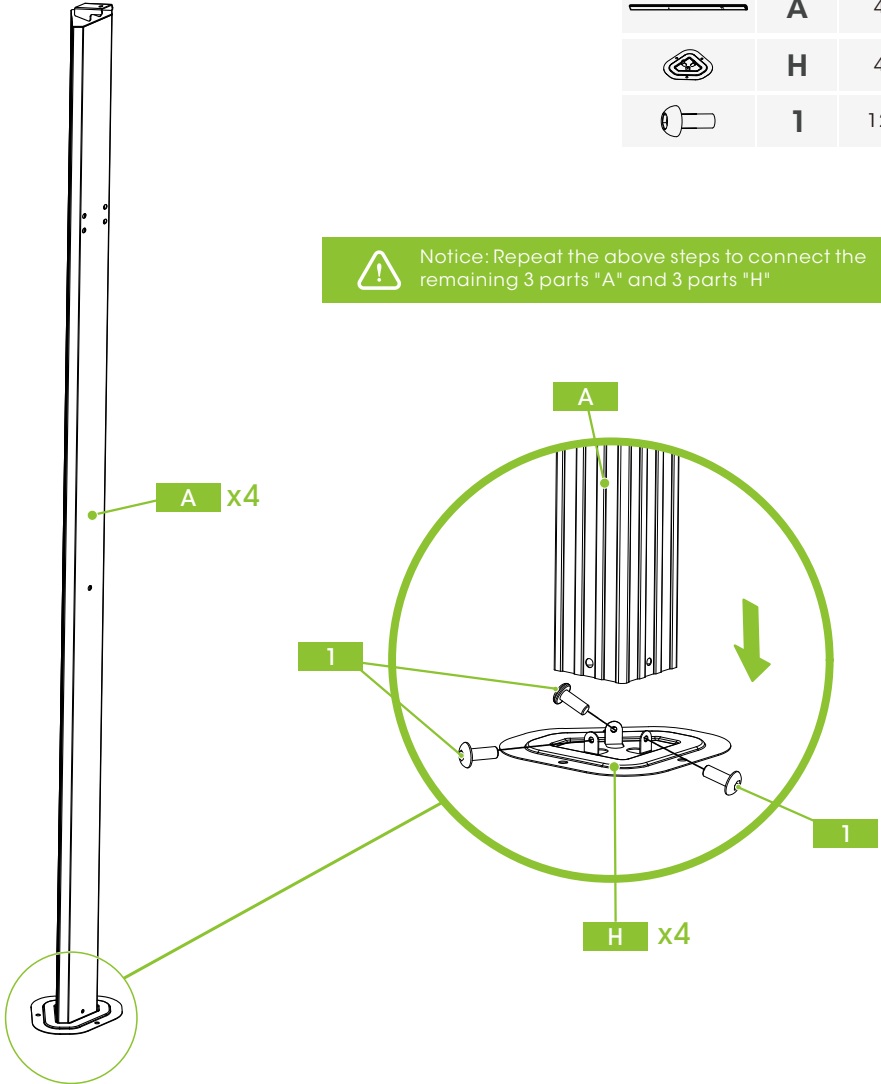

Notice: Repeat the above steps to connect the remaining 3 parts "A" and 3 parts "H"

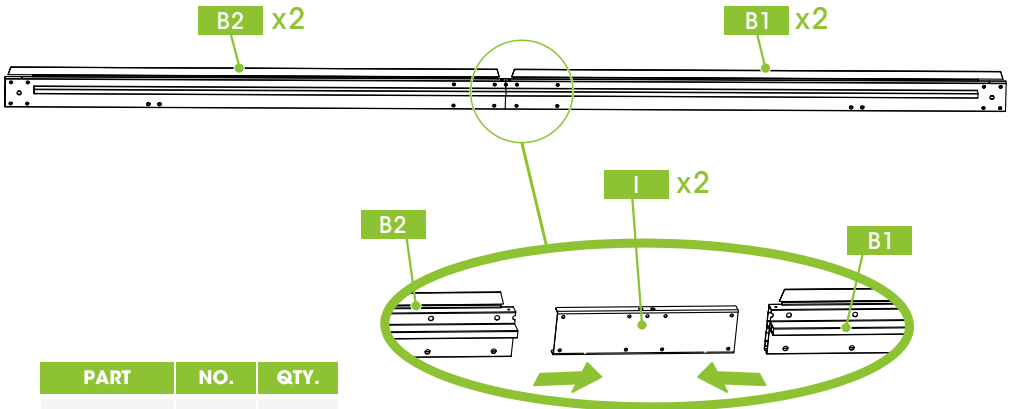

PRODUCT ASSEMBLY

2 Put the connecting part "I" into the right frame of part "B2" and the left frame of part "B1"



PART	NO.	QTY.
	B1	2
	B2	2
	I	2

3 Fasten them together with 8 screws "2" on the inside and 2 screws "2" on the bottom.

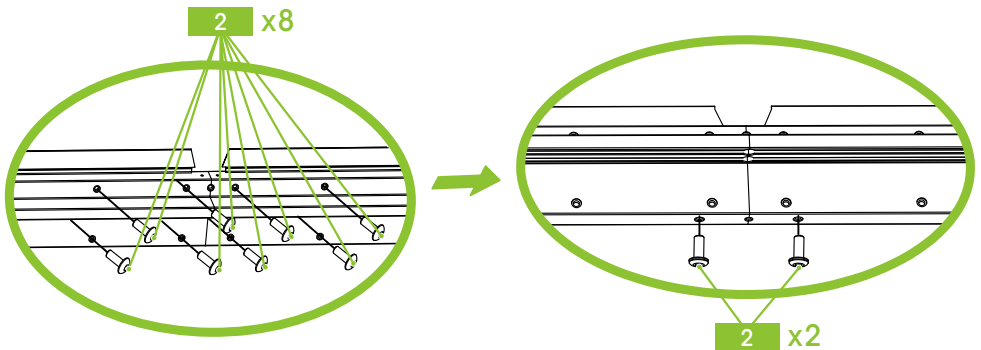





Notice: 1. Before fixing, please make sure all the screw holes are aligned.

PART	NO.	QTY.
	2	20

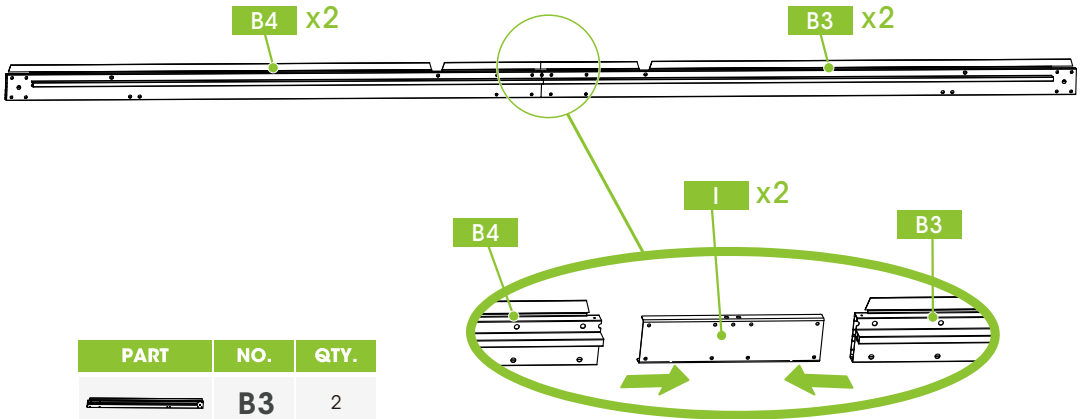
I PRODUCT ASSEMBLY

- 4** Place the connecting part "I" in the left frame of part "B3" and in the right frame of part "B4".



PART	NO.	QTY.
	B3	2
	B4	2
	I	2

- 5** Fastened together with 8 screws "2" on the inside and 2 screws "2" on the bottom

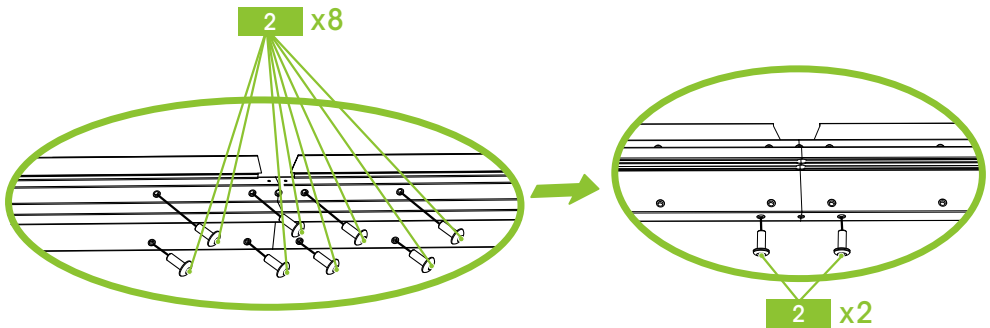

PART	NO.	QTY.
	2	20

PRODUCT ASSEMBLY

- 6** Attach the ends of part "B1" and part "B2" to the top of part "A", using 8 screws "2" to connect the two sides.

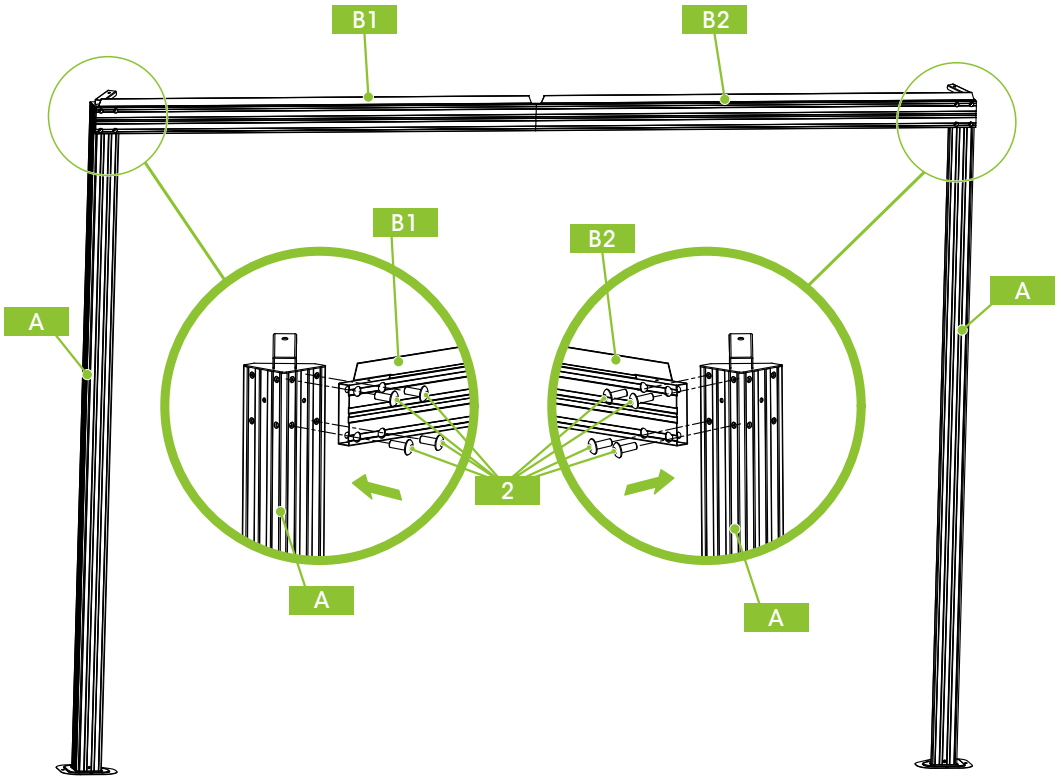

Notice: Repeat the above steps to complete the connection of the remaining part "B1" and part "B2" to the top of part "A".

PART	NO.	QTY.
	2	16

PRODUCT ASSEMBLY

- 7** After finishing attaching part "B1" and part "B2" to part "A", attach both sides of part "B3" and part "B4" to the top of part "A", Fixed with 8 screws "2".

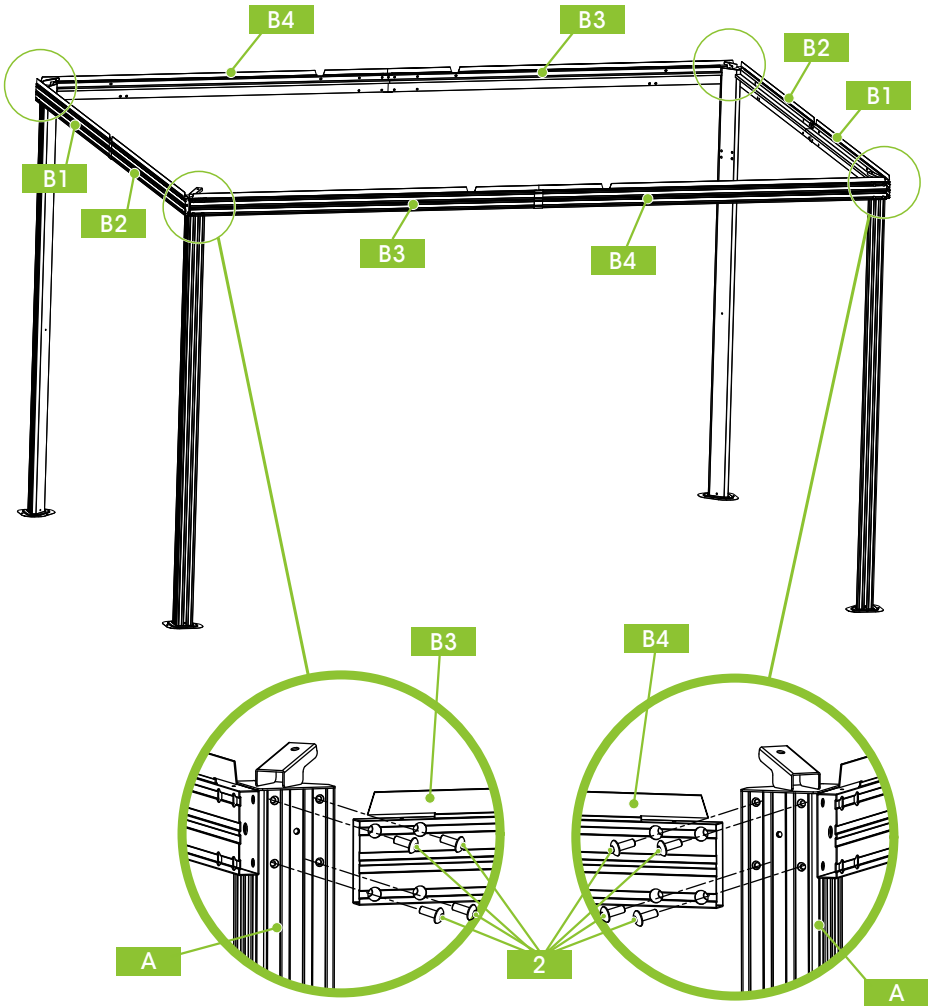

Notice: Repeat the above steps to complete the connection of the remaining part "B3" and part "B4" to the top of part "A".

PART	NO.	QTY.
	2	16





PRODUCT ASSEMBLY

8

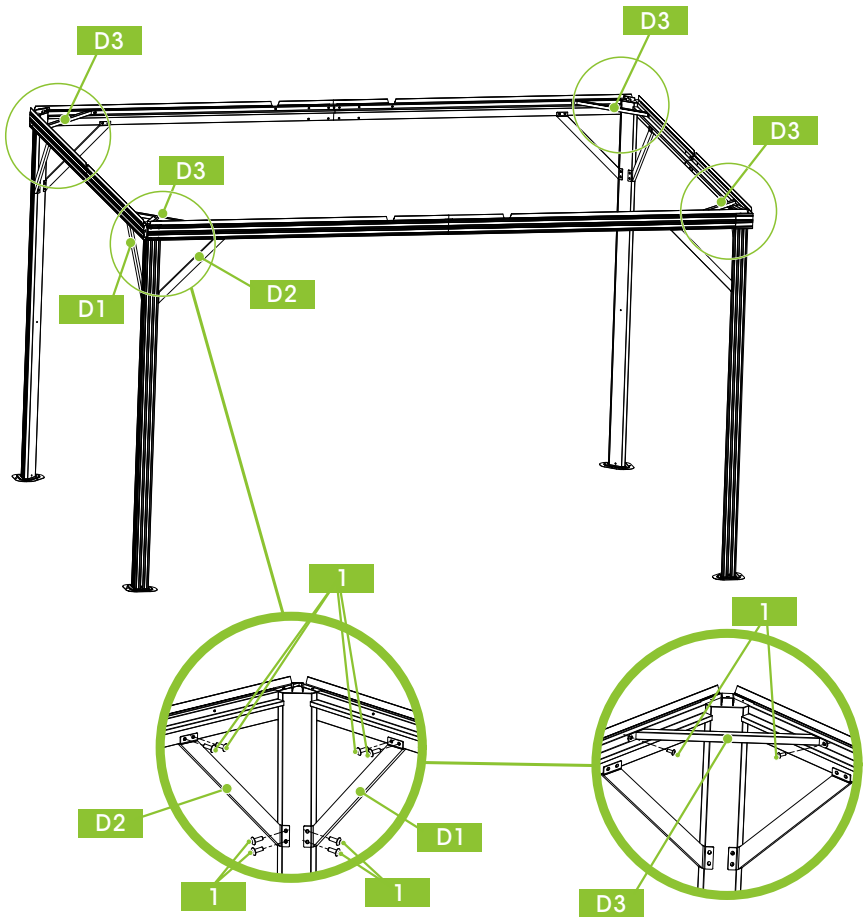
In the view from inside the gazebo, part "D1" is attached to the right side of the column using 4 screws "1", and part "D2" is attached to the left side of the column using 4 screws "1".

Use 8 screws "1" to attach part "D3" to the 8 holes of the cross member







PART	NO.	QTY.
	D1	4
	D2	4
	D3	4
	1	40

PRODUCT ASSEMBLY

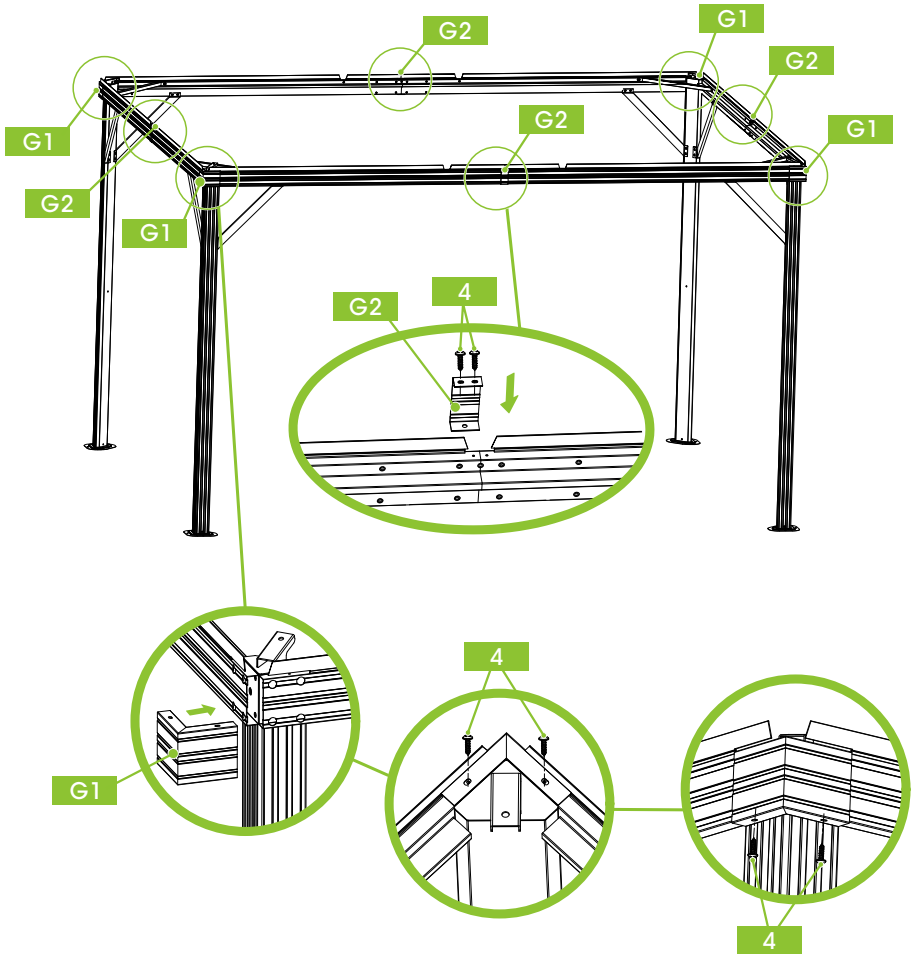
9 Attach the four parts "G1" to the four corners of the gazebo and fix them with 16 screws "4".



Use 8 screws "4" to fix part "G2" to the outside of the connection between part "B1" and part "B2" and the outside of the connection between part "B3" and part "B4".



PART	NO.	QTY.
	G1	4
	G2	4
	4	24

PRODUCT ASSEMBLY

- 10** Place 56 parts "U" in the slots of part "B3" and part "B4".
Place 48 parts "U" in the slots from the connection of part "B1" and part "B2".

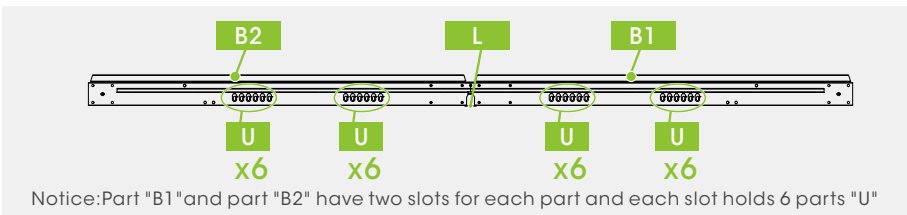
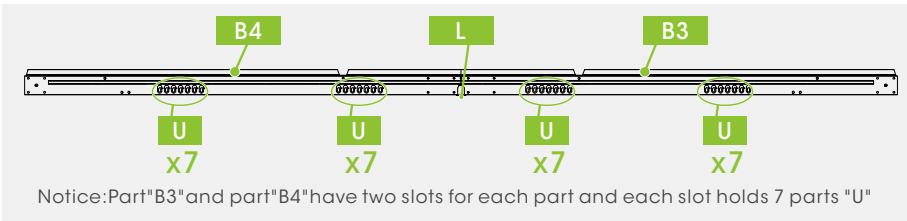
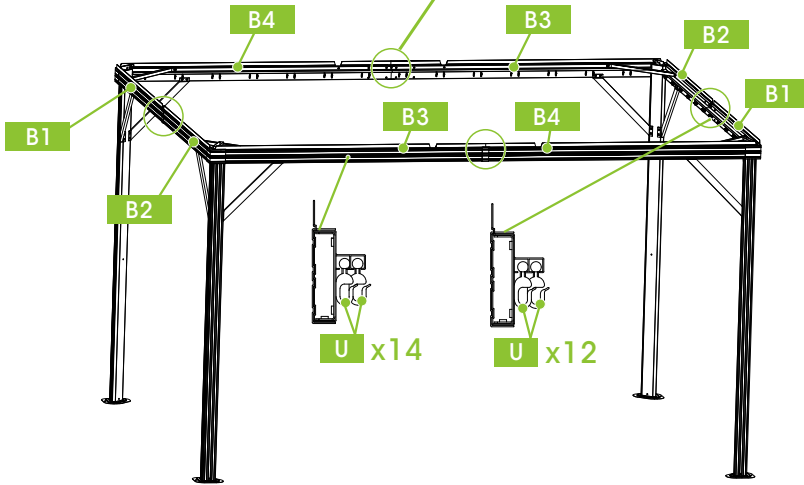
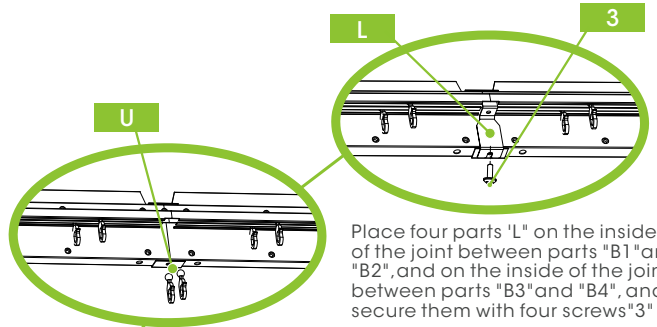

PART	NO.	QTY.
	L	4
	U	104
	3	4

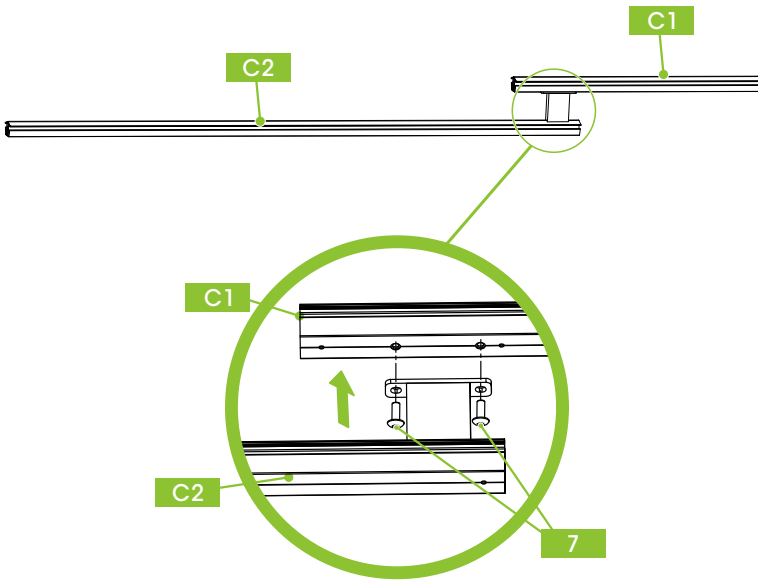

PRODUCT ASSEMBLY

11 Use eight "1#" screws to connect part "C1" to part "C2"





PART	NO.	QTY.
	C1	4
	C2	4
	7	8

PRODUCT ASSEMBLY

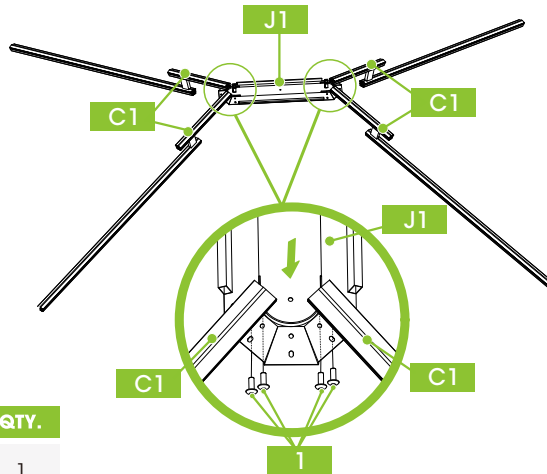
- 12** Place the top of the 4 parts "C1" on the sides of the part "J1" and fix them with 8 screws "1".



PART	NO.	QTY.
	J1	1
	1	8

- 13** Attach the bottom of part "C2" to the corners using 4 screws "1".

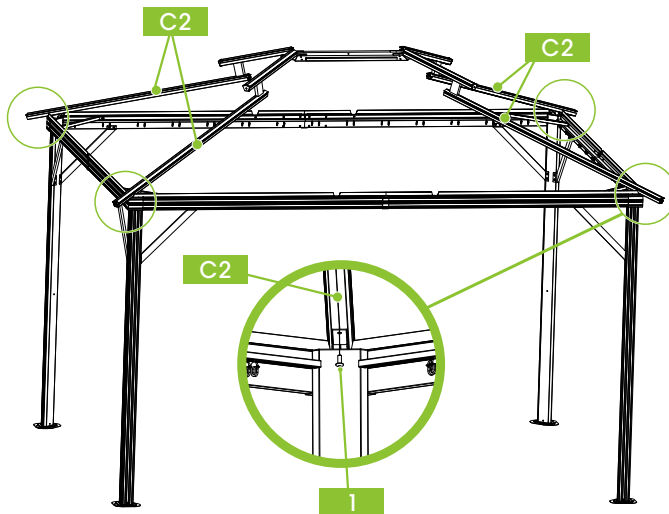

PART	NO.	QTY.
	1	4

PRODUCT ASSEMBLY

14 Place the 4 parts "C3" and 2 parts "C4" in the position shown in the figure and fix them with 18 screws "1".

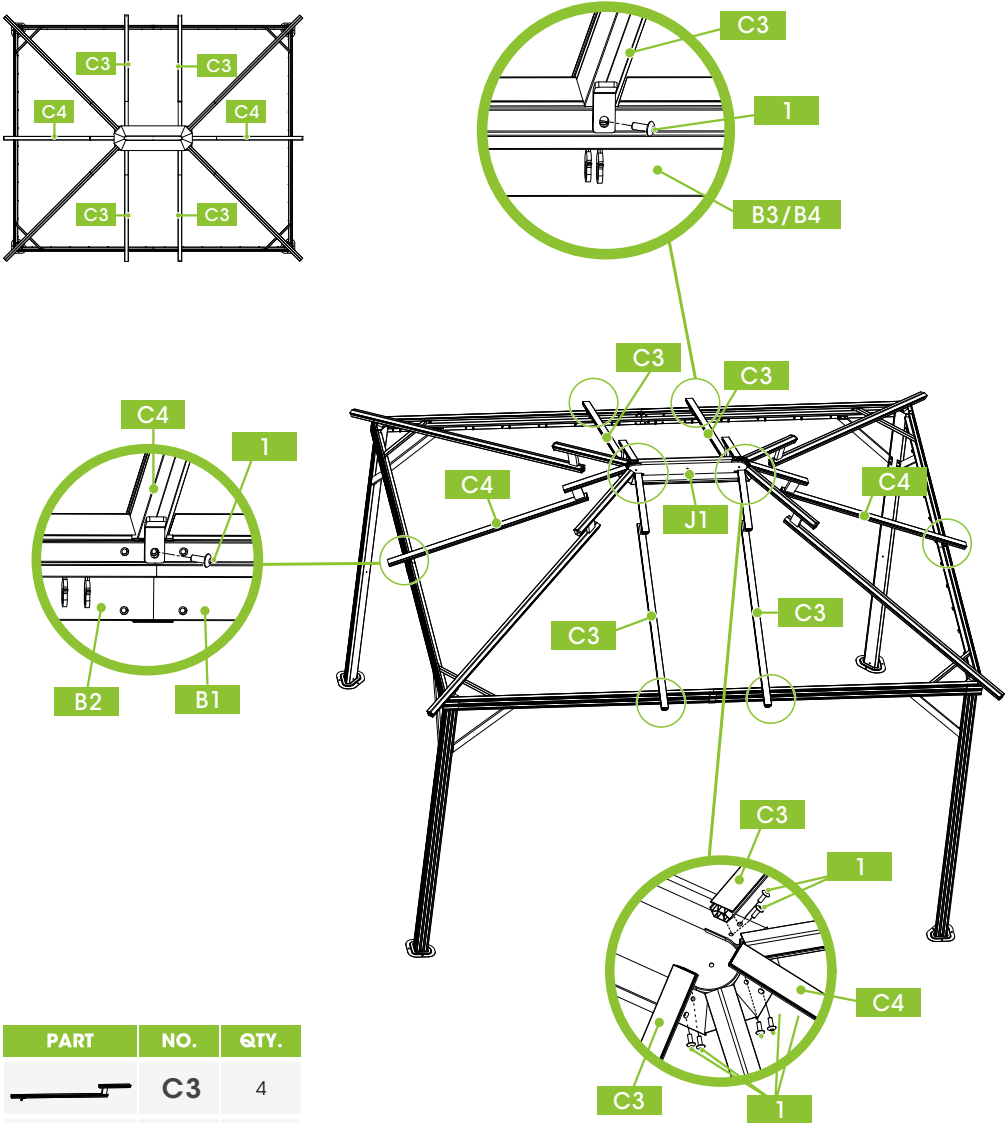



PART	NO.	QTY.
	C3	4
	C4	2
	1	18

PRODUCT ASSEMBLY

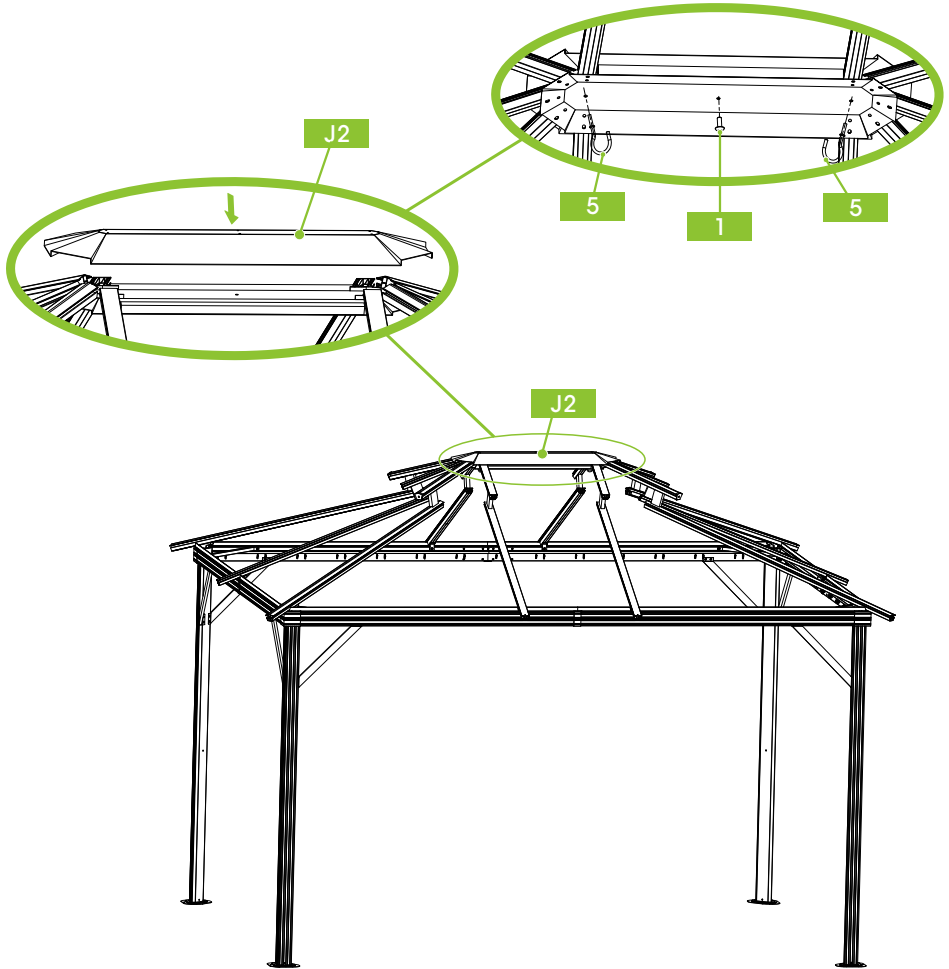
15 Place part "J2" on top of part "J1" and use a screw "1" and two screw "5" to fix it.

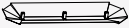





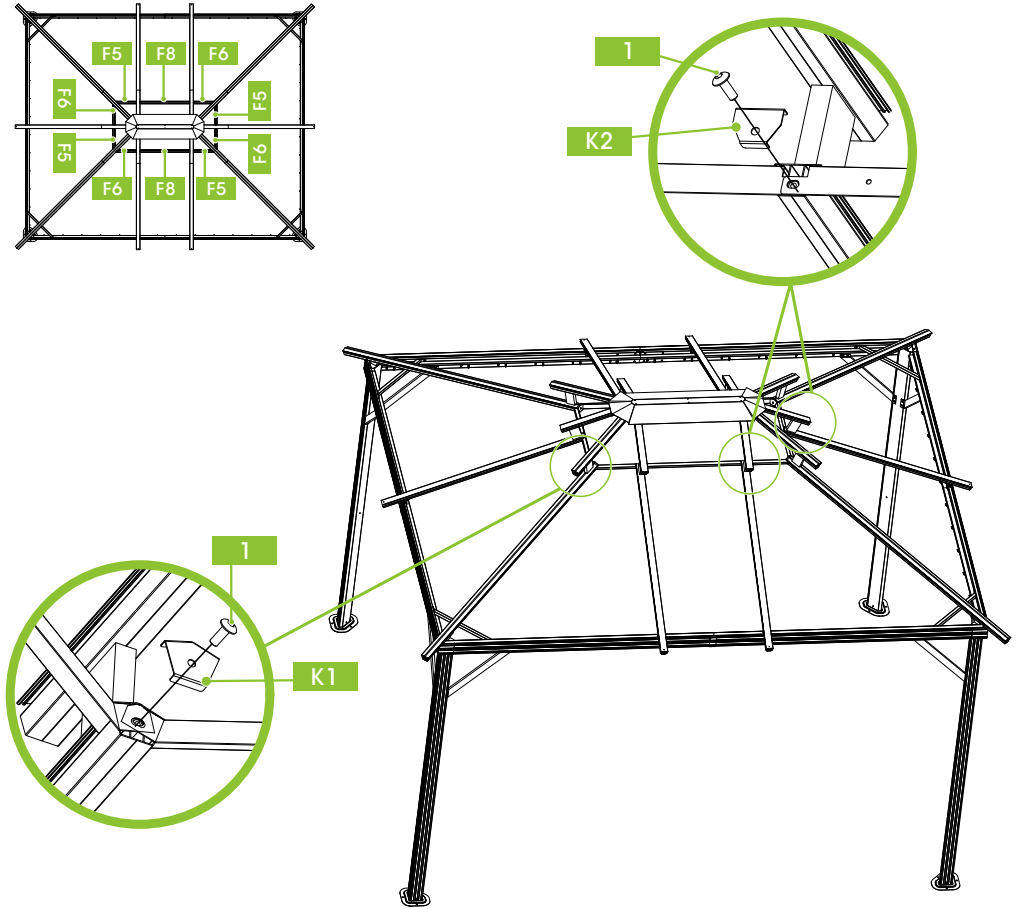

PART	NO.	QTY.
	J2	1
	1	1
	5	2

PRODUCT ASSEMBLY

16 The location of part "F5", part "F6" and part "F8" is shown below. Install part "F5", part "F6" and part "F8" with ten "1#" screws, install part "K2" to the connection of part "F5", part "F6" and part "F8", and place part "K1" at the four corners.



PART	NO.	QTY.	PART	NO.	QTY.
	F5	4		K1	4
	F6	4		K2	6
	F8	2		1	10

PRODUCT ASSEMBLY

17 Please note before installation

First, place part "S", part "S1" and part "S2" on the open space in the order of installation, so that they can be installed in order during installation.

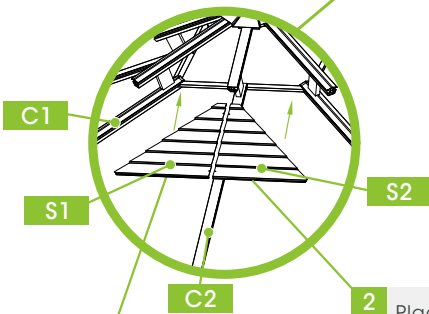
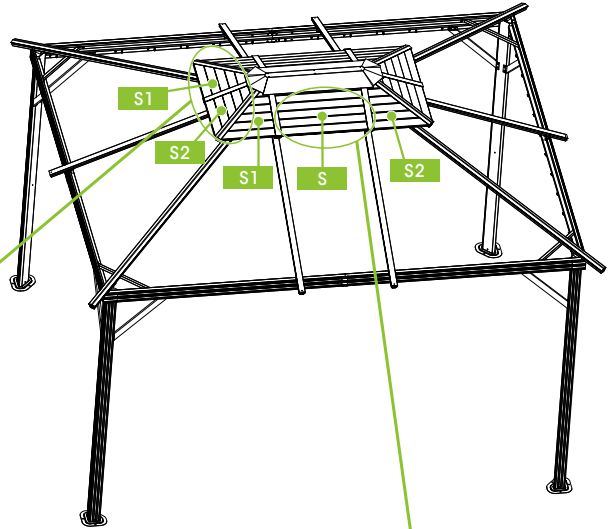
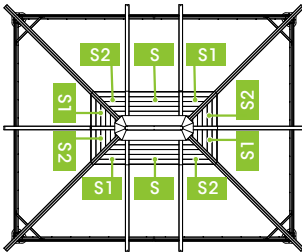

1 First place the 4 parts "S1" on the left side of the roof on each side.

2 Place the 4 parts "S2" on the right side of the roof on each side.

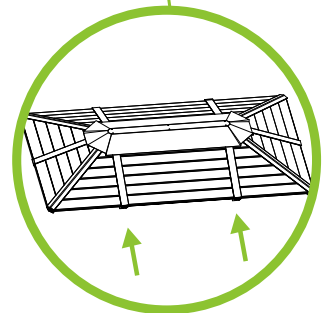

Place 2 parts "S" in the middle of part "S1" and part "S2".

PART	NO.	QTY.
	S	2
	S1	4
	S2	4







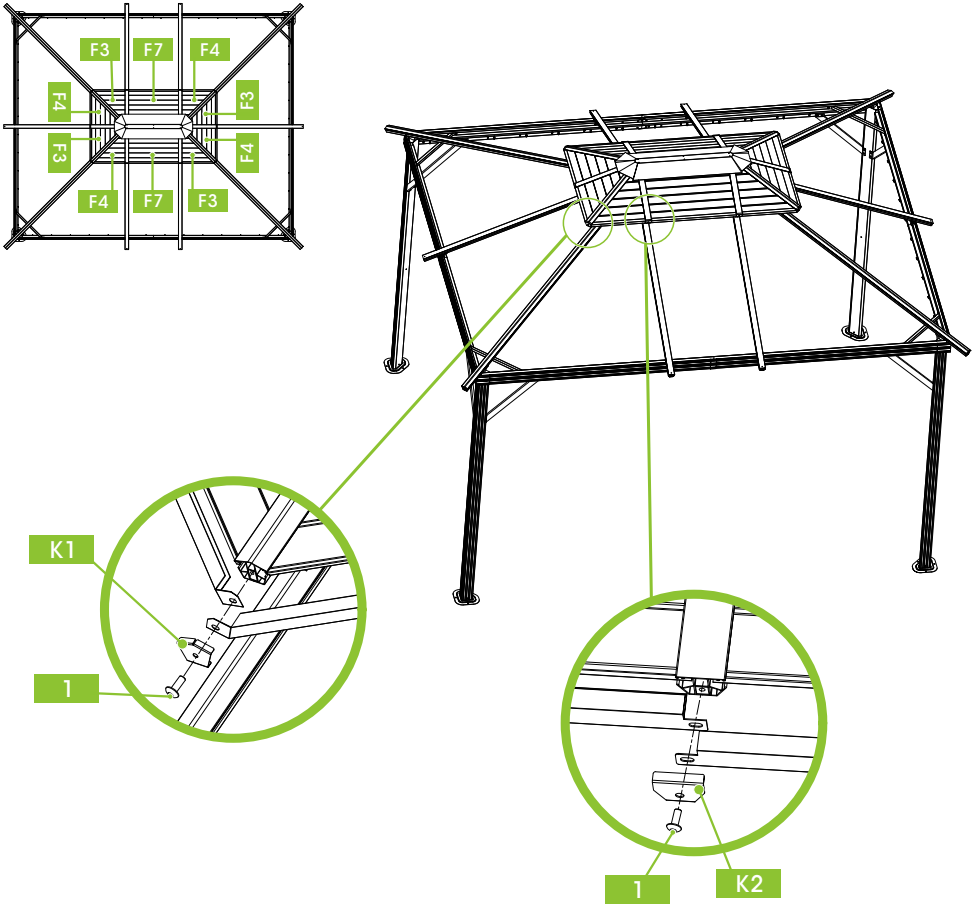

Notice: Any incorrect installation sequence may result in an unsuccessful installation. Scan the code to view the installation video.

PRODUCT ASSEMBLY

18 First, place part "F4" in the position shown in the figure, and place part "F7" to the right of part "F4", and use a part "K2" and a screw "1" to fix the right side of part "F4" to the left side of part "F7".

Place the parts in counterclockwise order and fix them with screws.







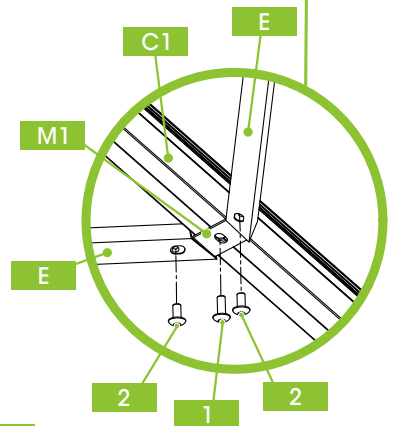
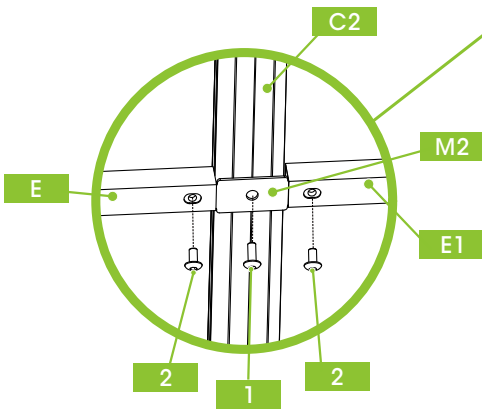
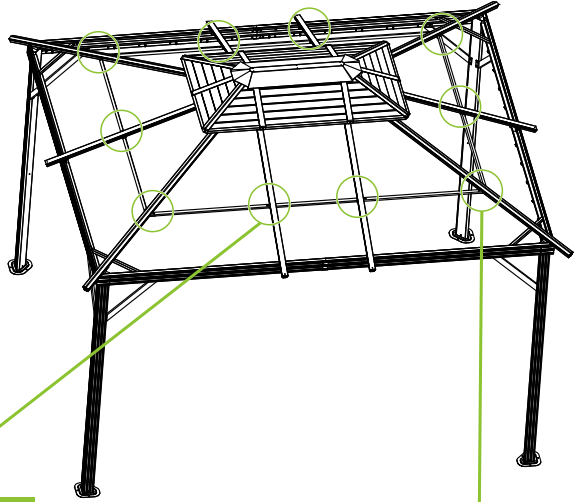
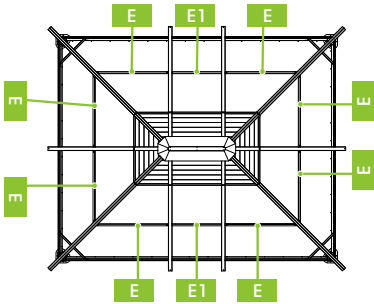

PART	NO.	QTY.	PART	NO.	QTY.
	F3	4		K1	4
	F4	4		K2	6
	F7	2		1	10

PRODUCT ASSEMBLY

19 Fix part "M1" and part "M2" to the middle of part "C2" and part "C4/C6" using 10 screws "1".

Assemble part "E" and part "E1" in clockwise or counterclockwise order, and secure them with 20 screws "2".



PART	NO.	QTY.	PART	NO.	QTY.
	E	8		M2	6
	E1	2		1	10
	M1	4		2	20

PRODUCT ASSEMBLY

20

Before installation, please place the parts in the position as shown in the figure below.

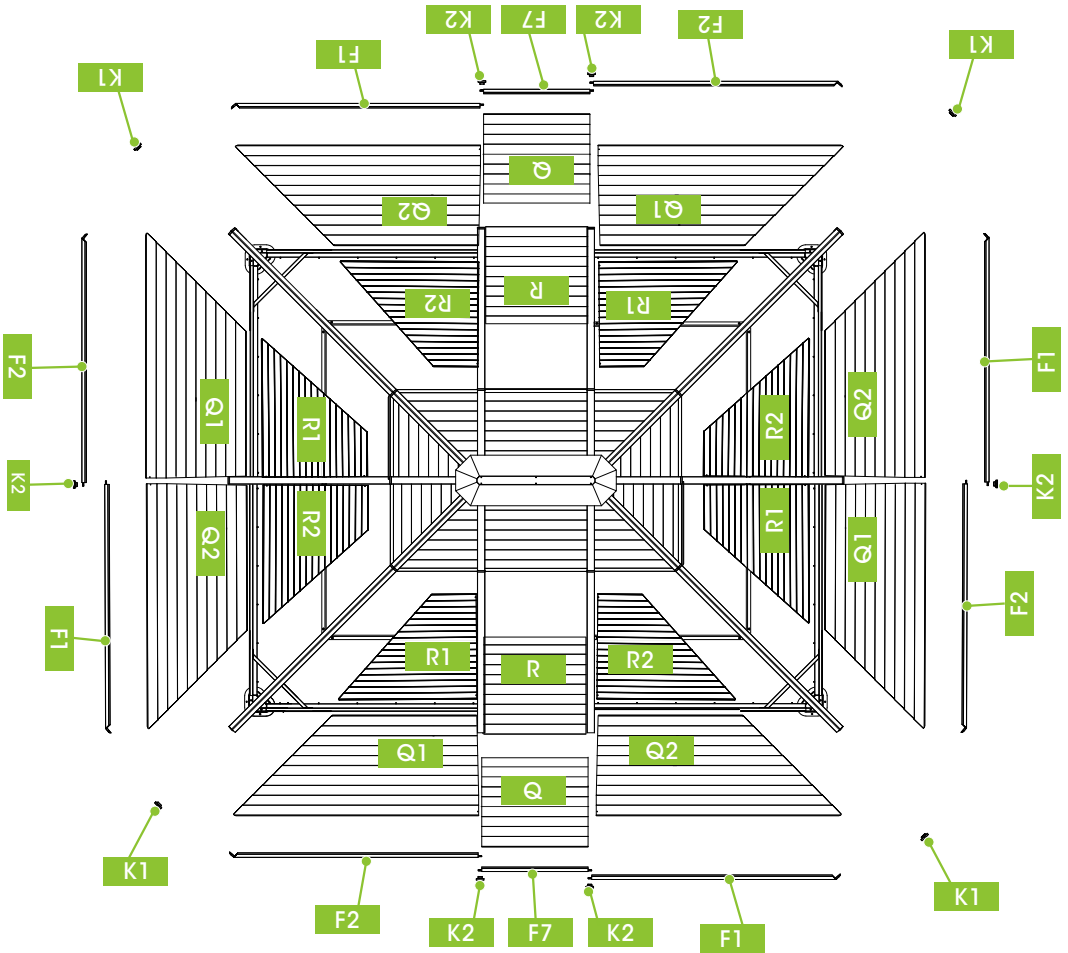

PRODUCT ASSEMBLY

21 Press part "R1" on top of part "Q1", and push part "R1" and part "Q1" into part "C3" as a whole.

Press part "R2" on top of part "Q2", and push part "R2" and part "Q2" into part "C3" as a whole.

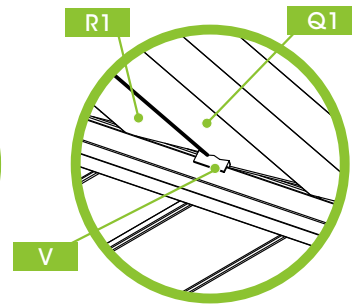
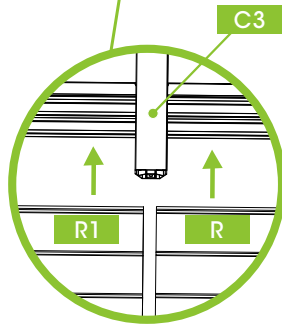
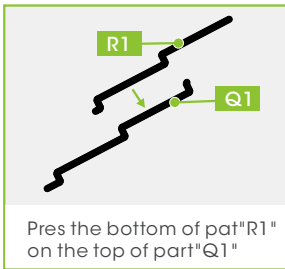
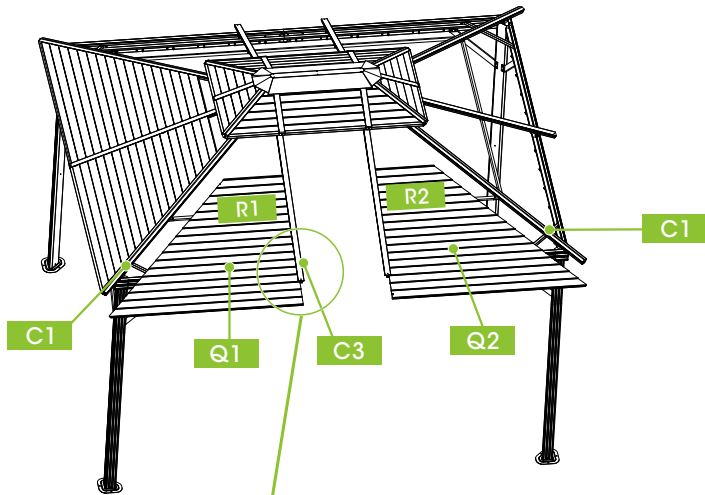

Snap part "V" into the area where part "Q1/Q2" and part "R1/R2" overlap.



Notice: Be sure to put part "R1 / Q1" "R2 / Q2" into the slot of part "C3" first and slide it upward, and then put part "R1 / Q1" "R2 / Q2" into the slot of part "C2", as the wrong installation method may cause installation errors.

PRODUCT ASSEMBLY

22

Press part "R" on top of part "Q", and push part "R" and part "Q" into part "C3" as a whole.

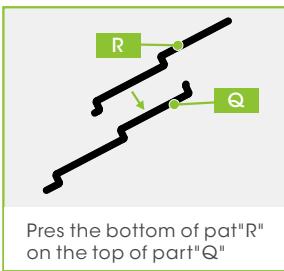
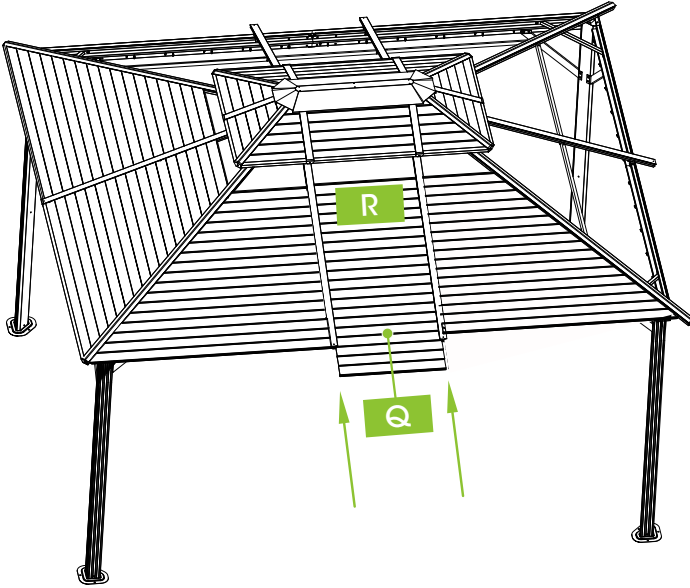

Press the bottom of part "R" on the top of part "Q"

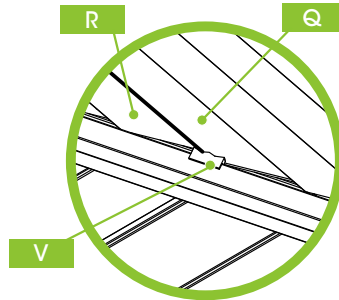

Snap part "V" into the area where part "Q" and part "R" overlap.

PRODUCT ASSEMBLY

23

Place part "F2" on the left side of each roof, use a part "K1" and a screw "1" to fix part "F2" on the left side and one part "K2" and one screw "1" are used to fix the right side of the part "F2". Install part "F7" and part "F1" in counter clock wise direction.

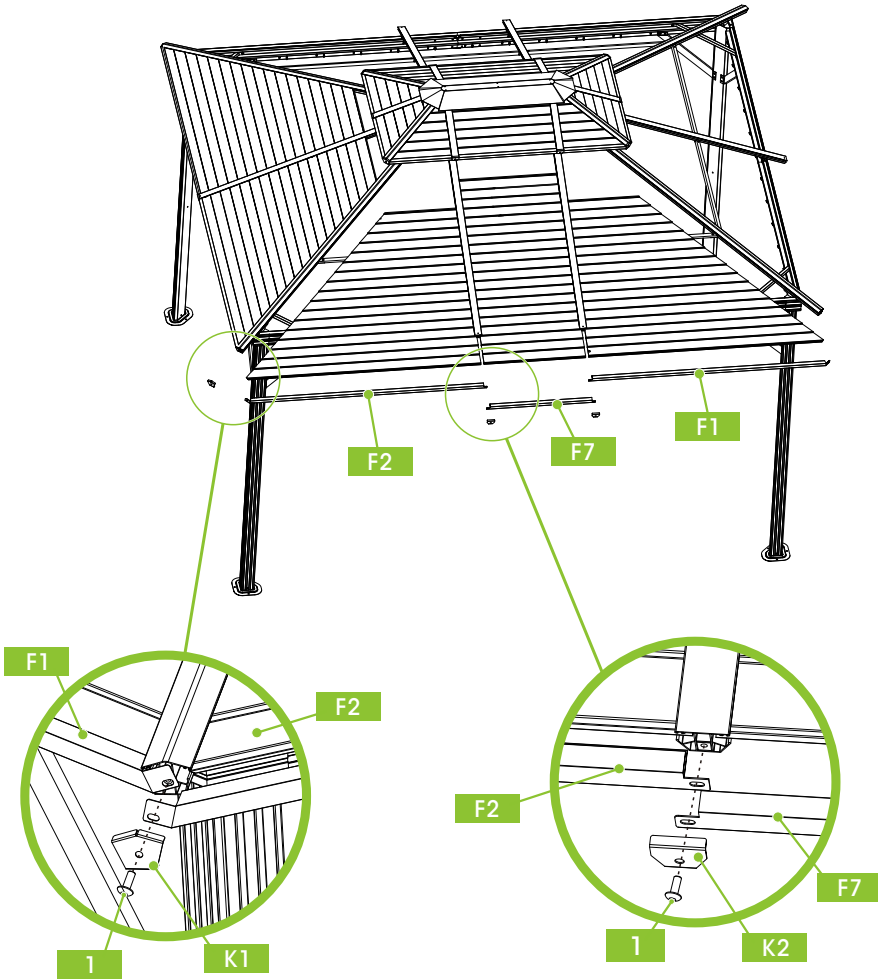

PRODUCT ASSEMBLY

24 Put part "V" in the position where "R1/R2" and "Q1"/"Q2" overlap in order.

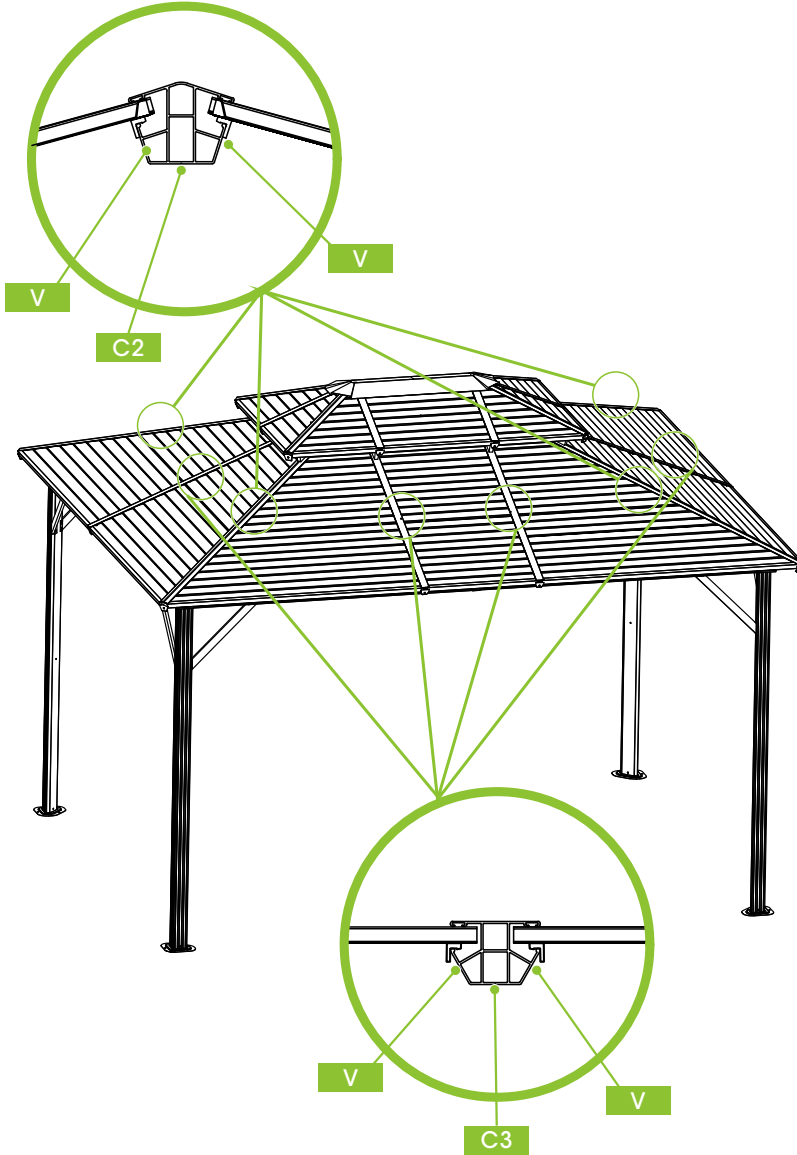

PRODUCT ASSEMBLY

25 Place the perimeter tent and netting on top of the hooks in turn.

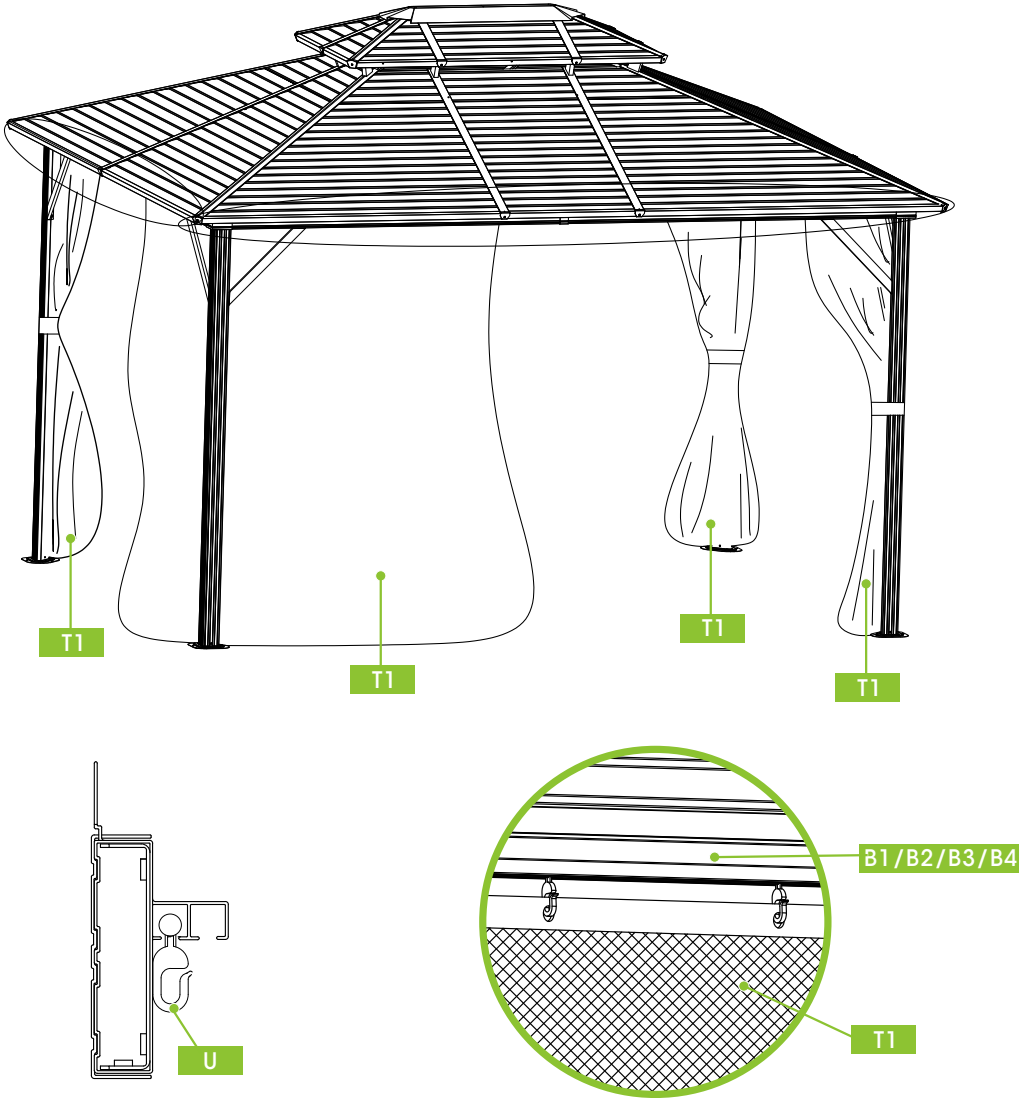

PART	NO.	QTY.
	T1	4

PRODUCT ASSEMBLY

26 Assembled part "T3" inside of the roof.

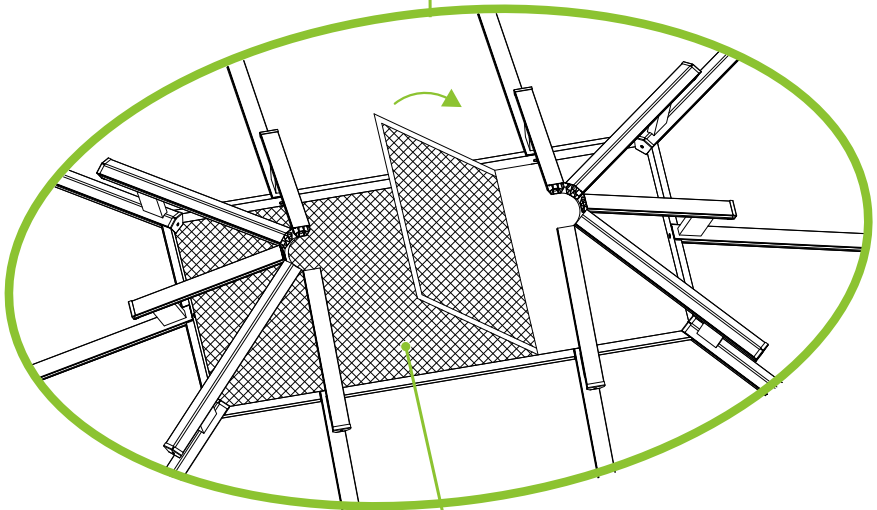
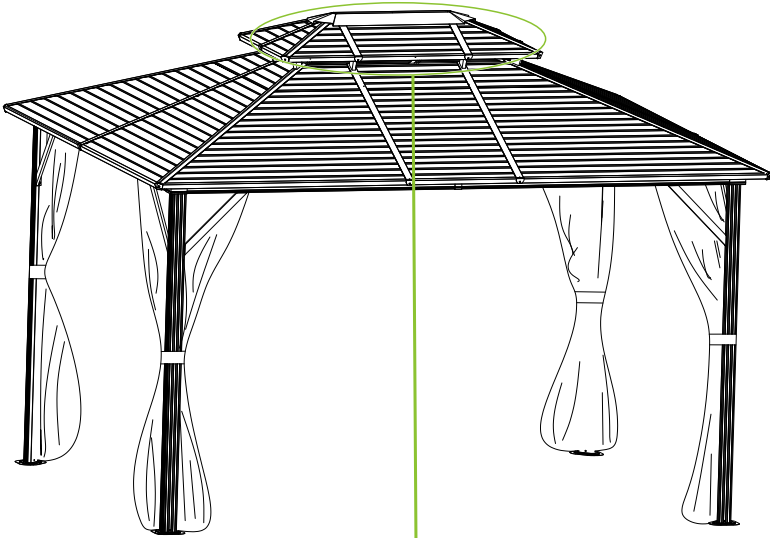

T3



PART	NO.	QTY.
	T3	1

PRODUCT ASSEMBLY

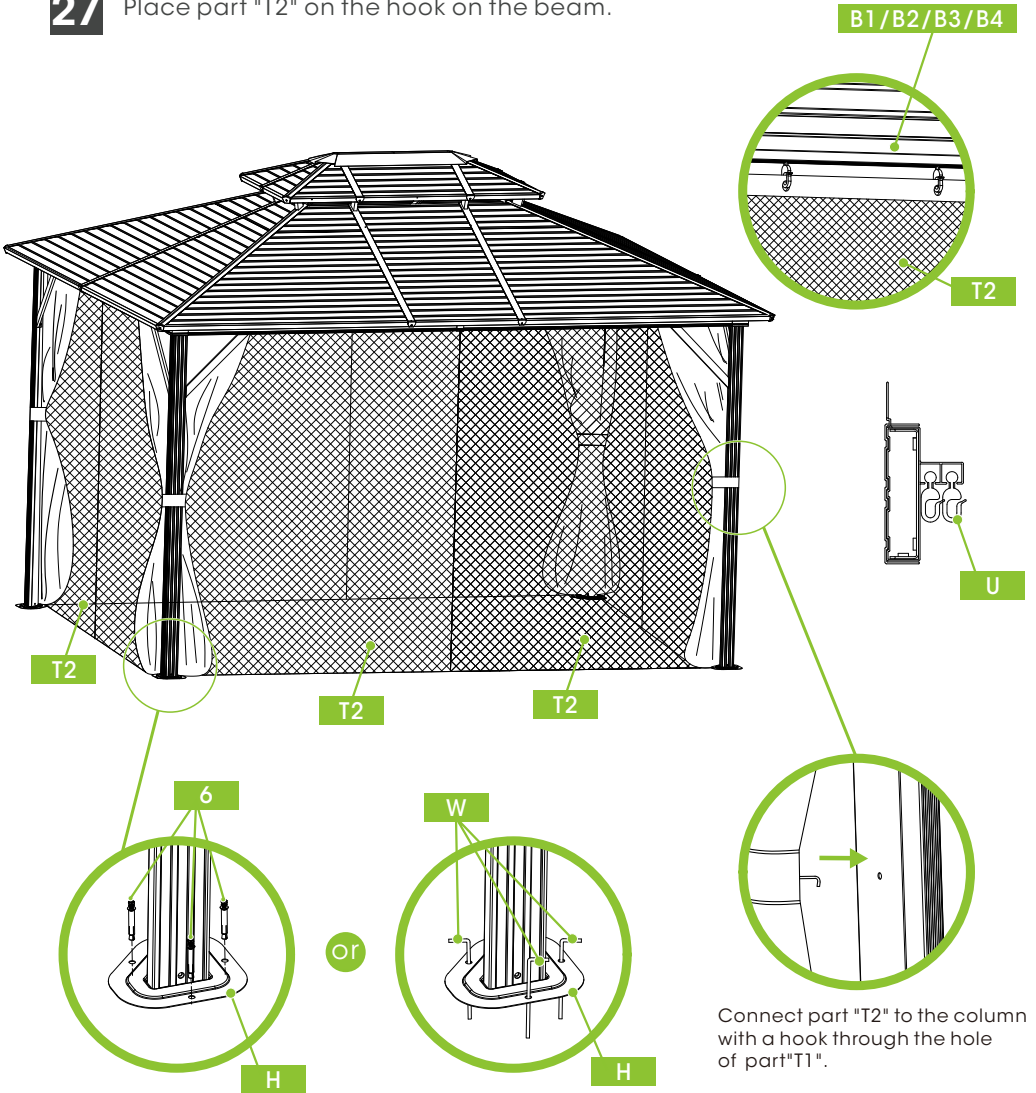
27 Place part "T2" on the hook on the beam.



Connect part "T2" to the column with a hook through the hole of part "T1".

PART	NO.	QTY.
	T2	4
	6	12
	W	12

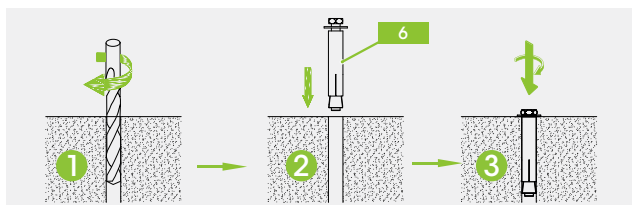

PRODUCT ASSEMBLY

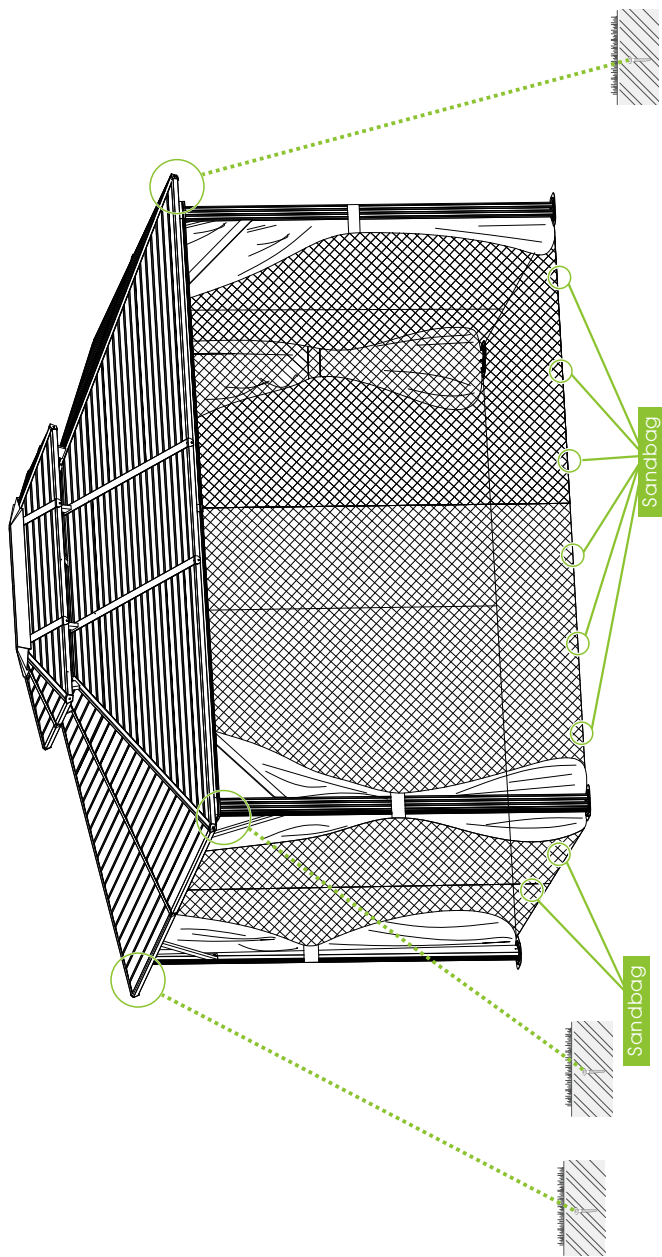

Suggestions for use

1. To avoid blowing the gazebo over in windy weather, please use a rope to pull at the four corners.
2. If you encounter high winds during use, you can place a heavy object in the hole at the bottom of the curtain to prevent it from fluttering.
3. Leakage may be encountered at the junction of the eaves, please use glass glue for bonding.
4. During heavy snowfall, please clear the snow from the roof in time to prevent it from bending.

HELP CENTER

Question about your product? We're here to help. Visit us at:

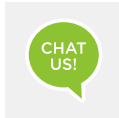

Chat Support



Product Inquiry

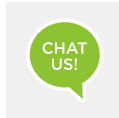

Orders FAQ



Product Assembly



Returns & Refunds

We Stand Behind the Quality of Their Furniture

If you have any issues with your item please let us know! We will always do our best to come up with a solution that you will be happy with.

Please get in touch with our customer service team before returning the product.

And pls do not throw the original box(es) if you have not finished assembling or confirmed no quality issues.

Length of return period:

Items can be returned within 30 days of purchase.

In the meanwhile, everything you purchased from us comes with a one-year warranty.

Who is responsible for the return shipping fee:

We will cover the return shipping fees if:

1. Your item has a manufacturing defect in its materials or workmanship. For example, torn wicker or misaligned screw holes. We will send you a prepaid shipping label after photos are sent.
2. Your item has been damaged in transit. For example, glass is broken or wicker is damaged. We will send you a prepaid shipping label after photos are sent.
3. You receive the wrong box(es) due to a warehouse error. We will send you a prepaid shipping label after photos are sent of the wrong SKU numbers on the outer box(es).
4. One or more boxes are lost in transit. We will send you a prepaid shipping label if you no longer want the item.

*However, we still hope to work with you for a better solution instead of a return. Please don't hesitate to contact our customer service team.

Customer will cover the return shipping fees if:

1. You don't like the product(s) after receiving the box(es).
2. You no longer need the product(s) but you have received the box(es).
3. You buy the product(s) by mistake but you have received the box(es).
4. Order/Shipment cancellation failed and you have received the box(es).

Return Request

In order to get a full refund as described in this return policy, all items must be: (1) In a brand new/unused condition, please provide photos before and after packaging. (2) When returning, all accessories and parts are firmly packed in all original packaging. If your return does not meet the requirements, you may not get a full refund.

When will I be refunded?

The refund is released once the goods have been returned to our warehouse.

What if the product is damaged/defective outside of the valid return period?

We want you to be a happy customer. Please reach out to us by email and we will come up with a solution to make sure you are satisfied.