

T1

Bitte unbedingt ausfüllen!

Name _____

Strasse _____

PLZ _____ Ort _____

Tel. _____

T2

Sehr geehrte Kunden,
wir freuen uns, dass Sie sich für ein Produkt aus dem Hause Pelipal entschieden haben. Sollte es trotz aller Bemühungen unsererseits, Ihnen ein qualitativ hochwertiges Möbelstück zu liefern, zu Fehlteilen kommen, schicken Sie bitte dieses ausgefüllte Blatt an

Fax.: +49 3443/434354

E-Mail: ersatzteile@pelipal.de

Bitte beachten Sie, dass Bauteile über 800mm Länge und 350mm Breite direkt bei Ihrem Möbelhändler zu beanstanden sind. Zur Reklamationsbearbeitung ist es unbedingt erforderlich **die Artikelnummer des Schrankes**, welche auf dem Etikett ersichtlich ist und den Markt, wo das Möbel erworben wurde anzugeben. Ausserdem tragen Sie unten bitte die benötigte Stückzahl ein. Viel Spass mit Ihrem neuen Badmöbel! Ihr Pelipal Team

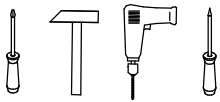

T3

Für den Zusammenbau sind 2 Personen erforderlich.

T4

Montage-Richtzeit 3 Stunden

10 x a DUEB-SMD-000005	Stück	6 x b EXZENTER-000015	Stück	2 x c TBD-26-115X00	Stück	2 x d ZPL-016X000	Stück	4 x e TRAE-002-000010	Stück
2 x f KA-200-1730			Stück	2 x g SCH-KA-M04X009	Stück	4 x h RWD-KEI-000060	Stück	4 x i DÜB-HLZ-008X030	Stück
1 x j AUF-001-000080	Stück	1 x k AUF-001-000090	Stück	10 x l SCH-SPA-035X015	Stück	4 x m SCH-KA-063X010	Stück	5 x n NAGEL-025X001	Stück
2 x p GRI-160-353010	Stück	4 x r SCH-KNO-M04X020	Stück	2 x s AUF-001-000020	Stück	4 x t EXZENTER-000014	Stück	1 x v TUER-DAEM-000010	Stück
1 x w TUER-ADA-000010	Stück	2 x x FSS-EF-CRG100E-311	Stück	12 x y SCH-SPA-035X020	Stück	2 x z ADK-AL1-005X008	Stück	1 x a VBD-000020	Stück
1 x ß SCH-RDK-045X045	Stück	1 x γ SCH-RDK-040X015	Stück						

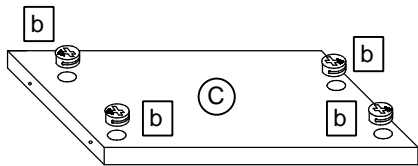
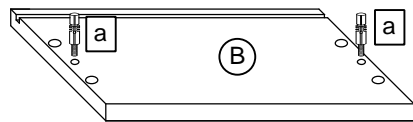
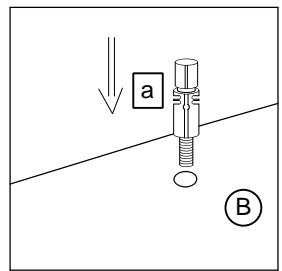
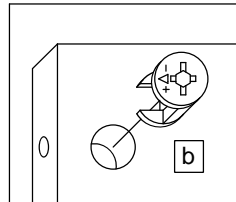
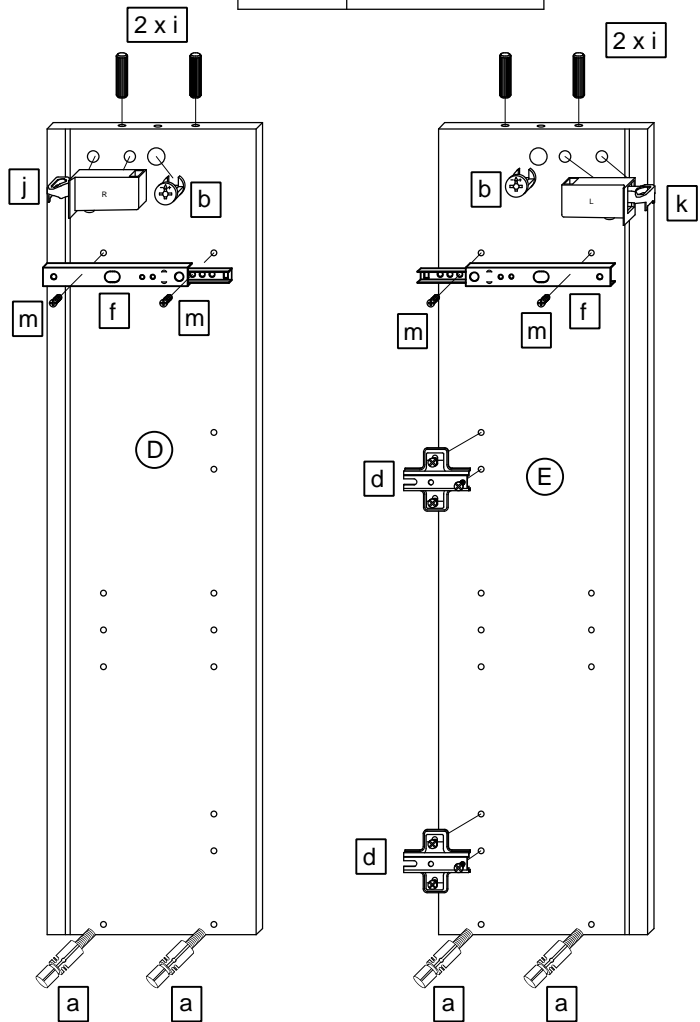
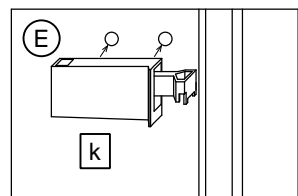
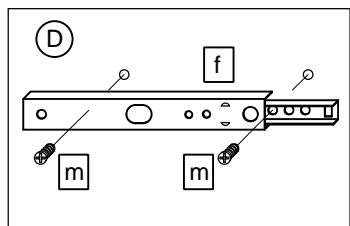
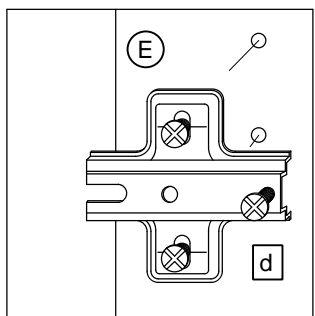
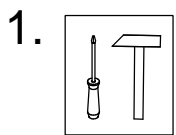
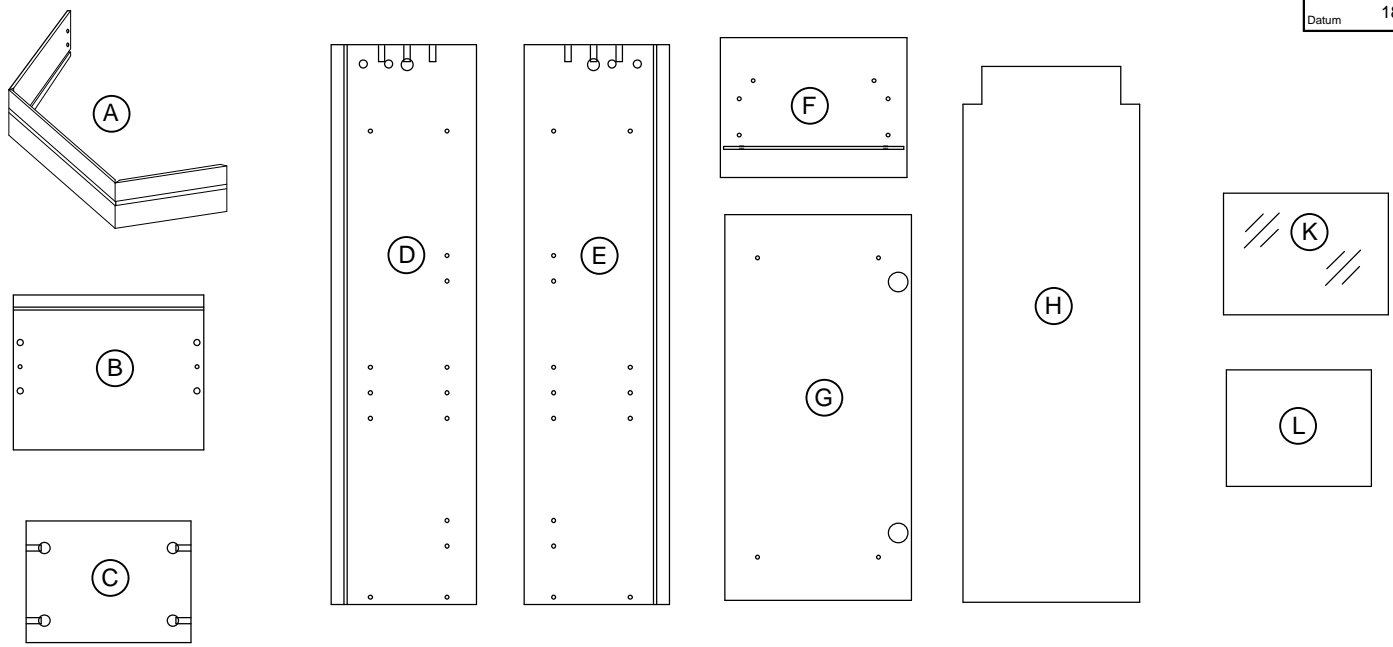

2.

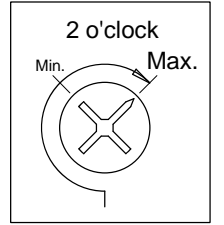
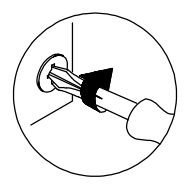
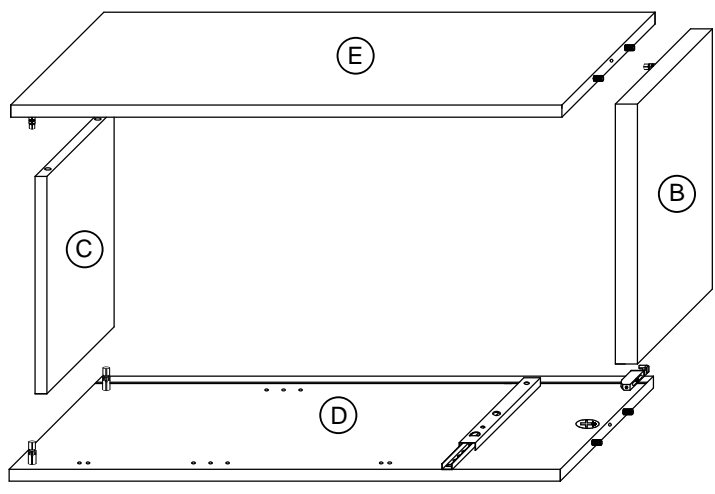
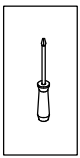

3.

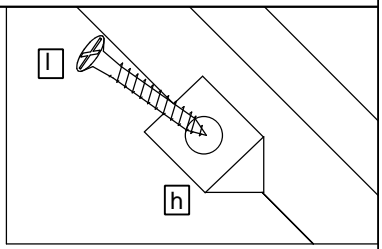
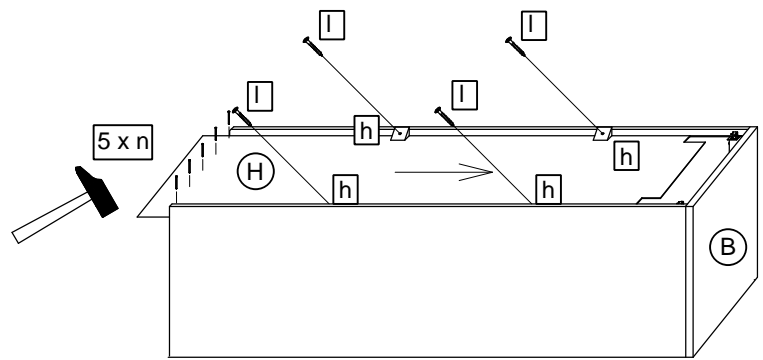
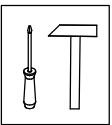

4.

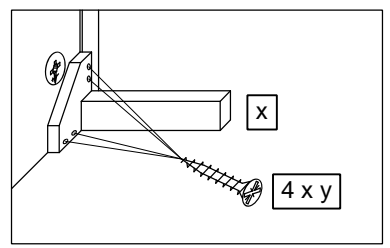
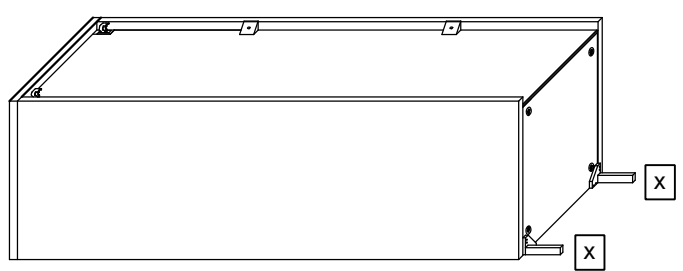
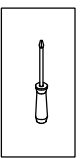

Das Etikett, welches sich unten rechts befindet bitte ausschneiden und auf der Rückwand mit Klebeband (nicht beiliegend) befestigen.



PELIPAL GmbH
Hans-Wilhelm-Peters-Straße 2
33189 Schlangen
Germany

5.

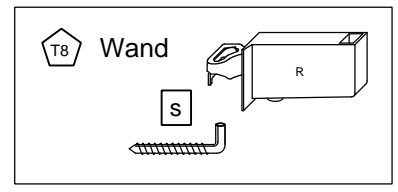
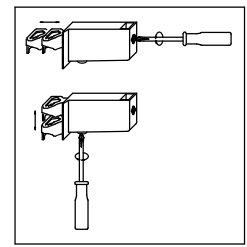
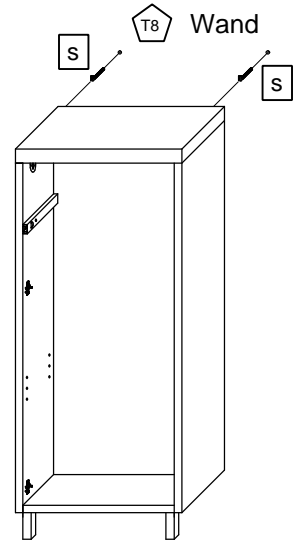
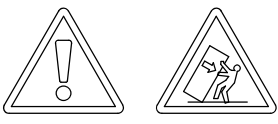
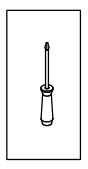

T6 Die Schrankaufhänger dienen zur Kippsicherung des Schrankes und müssen grundsätzlich montiert werden.

T9 Lassen Sie den Schrank nur durch fachkundige Personen mit für die Wand geeignetem Montagematerialien montieren.

6.

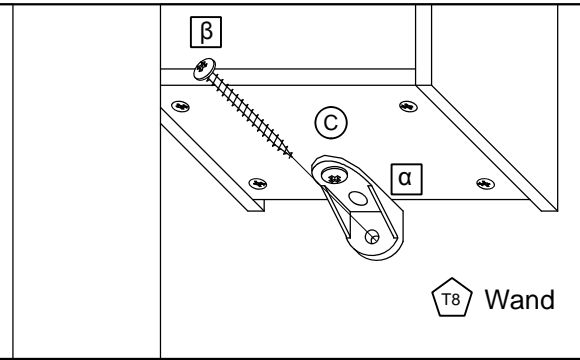
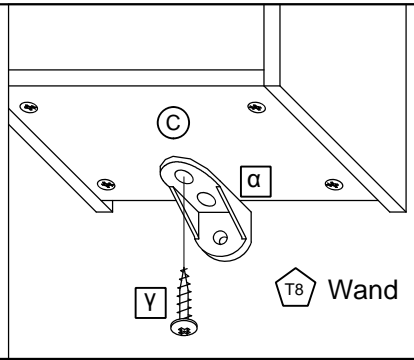
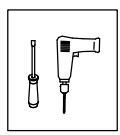

7.

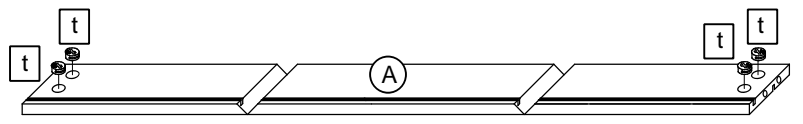
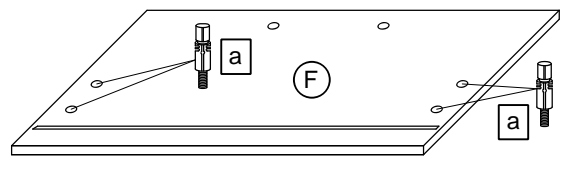
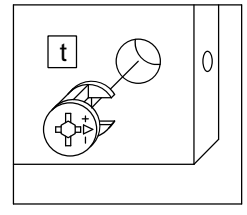
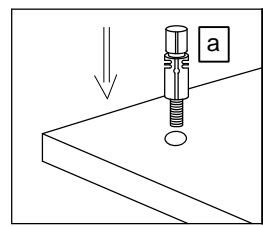
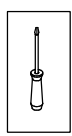

8.

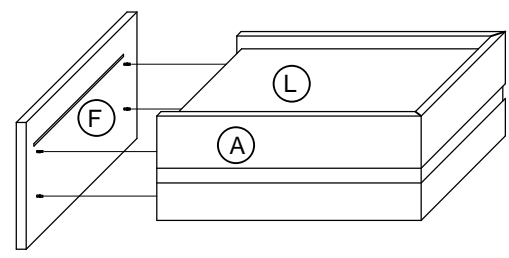
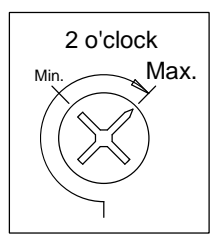
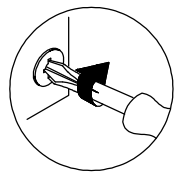
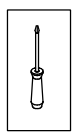

9.

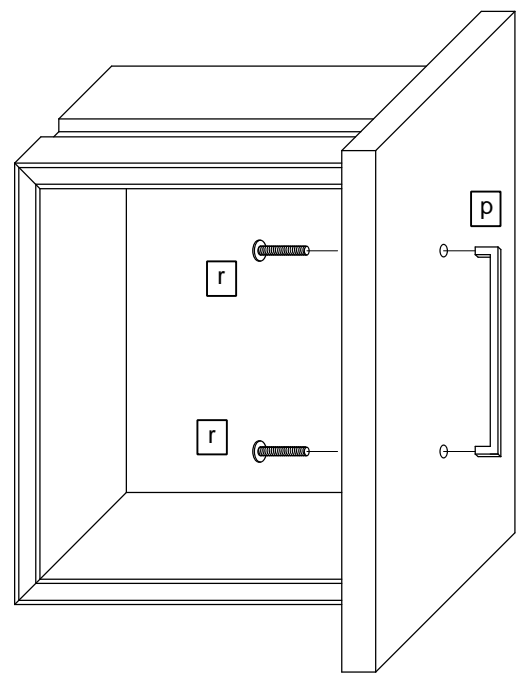
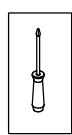

10.

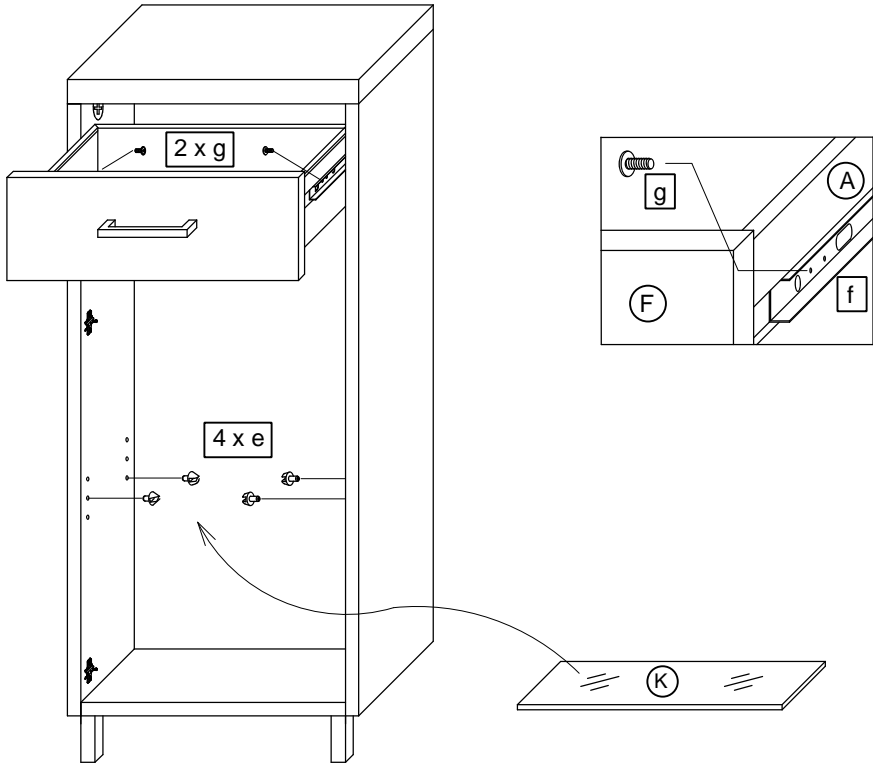

11.

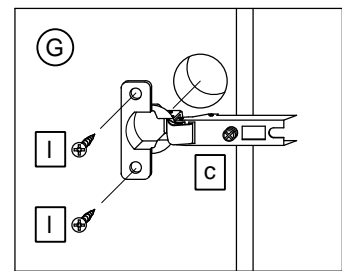
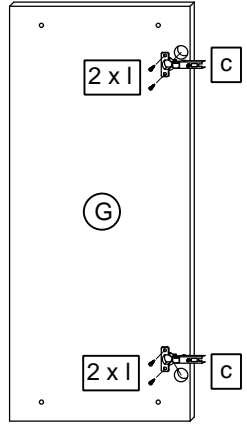
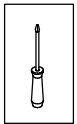

12.

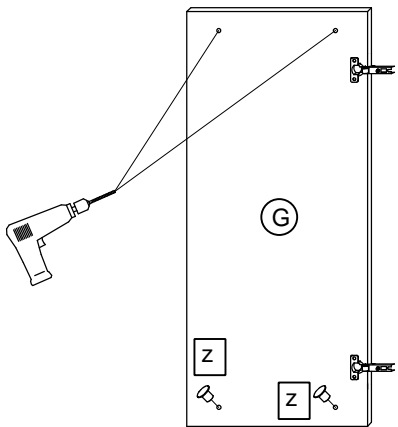
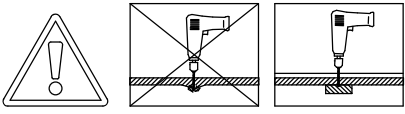

13.

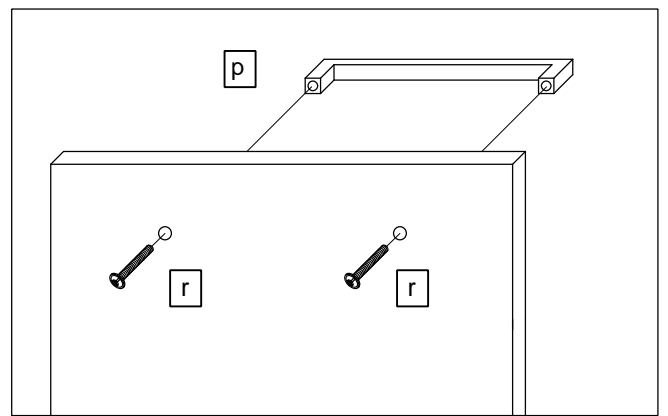
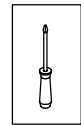

14.

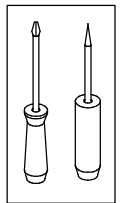

T11 Bei Türmontage das Scharnier einhängen, bis Anschlag öffnen und anschließend festschrauben.

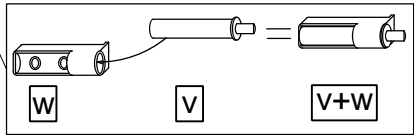
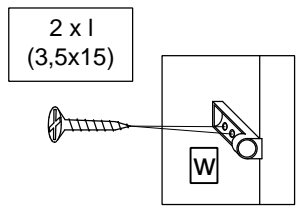
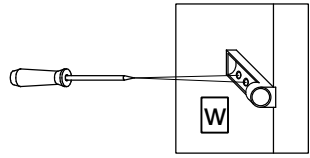
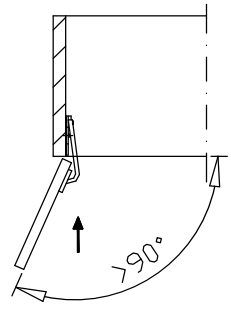
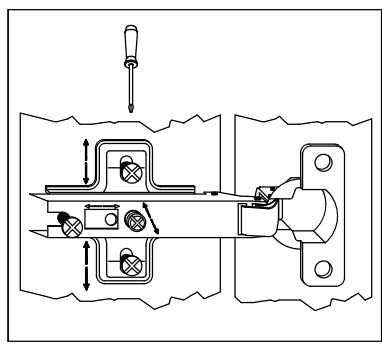
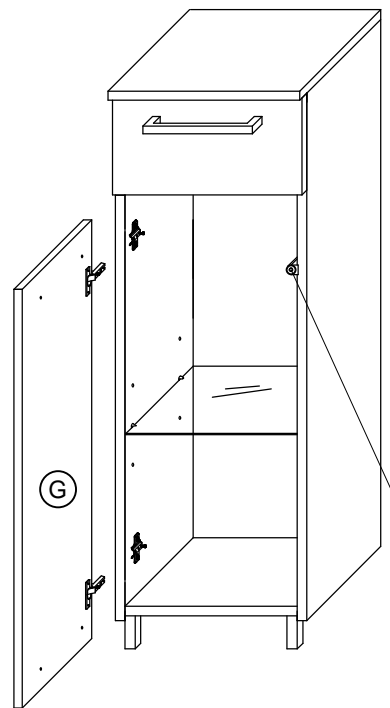

T12 Das Möbel bitte nur mit einem feuchten Tuch reinigen.